

CR, CRI, CRN, CRE, CRIE, CRNE

Vertical multistage centrifugal pumps
50 Hz



1. Product data	3	7. Motor data	78
Introduction	3	Standard motors for CR, CRI, CRN, 50 Hz	78
Performance range of CR, CRI, CRN	4	E-motors for CRE, CRIE, CRNE, 50 Hz	79
Performance range of CRE, CRIE, CRNE	4		
Applications	5	8. Pumped liquids	80
Product range	6	List of pumped liquids	80
Pump	8		
Motor	8	9. Accessories	82
Terminal box positions	9	Pipework connection	82
Ambient temperature	9	Potentiometer for CRE, CRIE, CRNE	89
Viscosity	9	G10-LON interface for CRE, CRIE, CRNE	89
		LiqTec for CR(E), CRI(E) and CRN(E)	89
2. Control of E-pumps	10	R100 remote control	89
Examples of E-pump applications	10	EMC filter for CRE, CRIE, CRNE	89
Control modes for E-pumps	12	Sensors for CRE, CRIE, CRNE	90
3. Construction	13	10. Variants	91
CR(E) 1s, 1, 3, 5, 10, 15 and 20	13	Lists of variants	91
CRI(E), CRN(E) 1s, 1, 3, 5, 10, 15 and 20	13		
CR(E) 32, 45, 64 and 90	14	11. Further product documentation	92
CRN(E) 32, 45, 64 and 90	14	WebCAPS	92
CR(E) 120 and 150	15	WinCAPS	93
CRN(E) 120 and 150	15		
Type keys	16		
4. Operating and inlet pressures	17		
Maximum operating pressure and liquid temperature	17		
	17		
Operating range of the shaft seal	18		
Maximum inlet pressure	19		
5. Selection and sizing	20		
Selection of pumps	20		
How to read the curve charts	25		
Guidelines to performance curves	25		
6. Performance curves/technical data	26		
CR 1s	26		
CRI, CRN 1s	28		
CR, CRE 1	30		
CRI, CRN, CRIE, CRNE 1	32		
CR, CRE 3	34		
CRI, CRN, CRIE, CRNE 3	36		
CR, CRE 5	38		
CRI, CRN, CRIE, CRNE 5	40		
CR, CRE 10	42		
CRI, CRN, CRIE, CRNE 10	44		
CR, CRE 15	46		
CRI, CRN, CRIE, CRNE 15	48		
CR, CRE 20	50		
CRI, CRN, CRIE, CRNE 20	52		
CR, CRE 32	54		
CRN, CRNE 32	56		
CR, CRE 45	58		
CRN, CRNE 45	60		
CR, CRE 64	62		
CRN, CRNE 64	64		
CR, CRE 90	66		
CRN, CRNE 90	68		
CR, CRE 120	70		
CRN, CRNE 120	72		
CR, CRE 150	74		
CRN, CRNE 150	76		

1. Product data

Introduction

This data booklet deals with Grundfos CR, CRI and CRN as well as CRE, CRIE and CRNE pumps.

CR, CRI, CRN



GR 5381

Fig. 1 CR, CRI and CRN pumps

CR, CRI and CRN pumps are vertical, multistage centrifugal pumps. The in-line design of the pumps enables installation in a horizontal one-pipe system where the suction and discharge ports are in the same horizontal level and have the same pipe dimensions. This design provides a more compact pump design and pipework.

Grundfos CR pumps are available in various sizes and various numbers of stages to provide the flow and pressure required.

CR pumps are designed for a variety of applications ranging from the pumping of potable water to the pumping of chemicals. The pumps are therefore suitable for a wide diversity of pumping systems where the performance and material of the pump meet specific demands.

The CR pumps consist of two main components: the motor and the pump unit. The CR pump motor is a Grundfos motor designed to EN standards.

The pump unit consists of optimised hydraulics, various types of connections, a sleeve, a pump head and various other parts.

CR pumps are available in various material versions according to the pumped liquid.

CRE, CRIE, CRNE



TM02 7397 0511

Fig. 2 CRE, CRIE and CRNE pumps

CRE, CRIE and CRNE pumps are built on the basis of CR, CRI, CRN pumps.

CRE, CRIE and CRNE pumps belong to the so-called E-pump family. CRE, CRIE and CRNE pumps are referred to as E-pumps.

The difference between the CR and CRE pump ranges is the motor. CRE, CRIE and CRNE pumps are fitted with an E-motor, i.e. a motor with built-in frequency converter.

The CRE pump motor is a Grundfos MGE motor designed to EN standards.

The frequency converter enables continuously variable control of the motor speed, which makes it possible to set the pump to operation at any duty point. The purpose of continuously variable speed control of the motor speed is to adjust the performance to a given requirement.

CRE, CRIE and CRNE pumps are available with an integrated pressure sensor connected to the frequency converter.

The pump materials are identical to those of the CR, CRI and CRN pump range.

Selecting a CRE pump

Select a CRE pump if the following features are required:

- Controlled operation, i.e. consumption fluctuates.
- Constant pressure.
- Communication with the pump.

Adaptation of performance through frequency-controlled speed control offers obvious benefits such as:

- energy savings
- increased comfort
- control and monitoring of the pump performance.

Performance range of CR, CRI, CRN

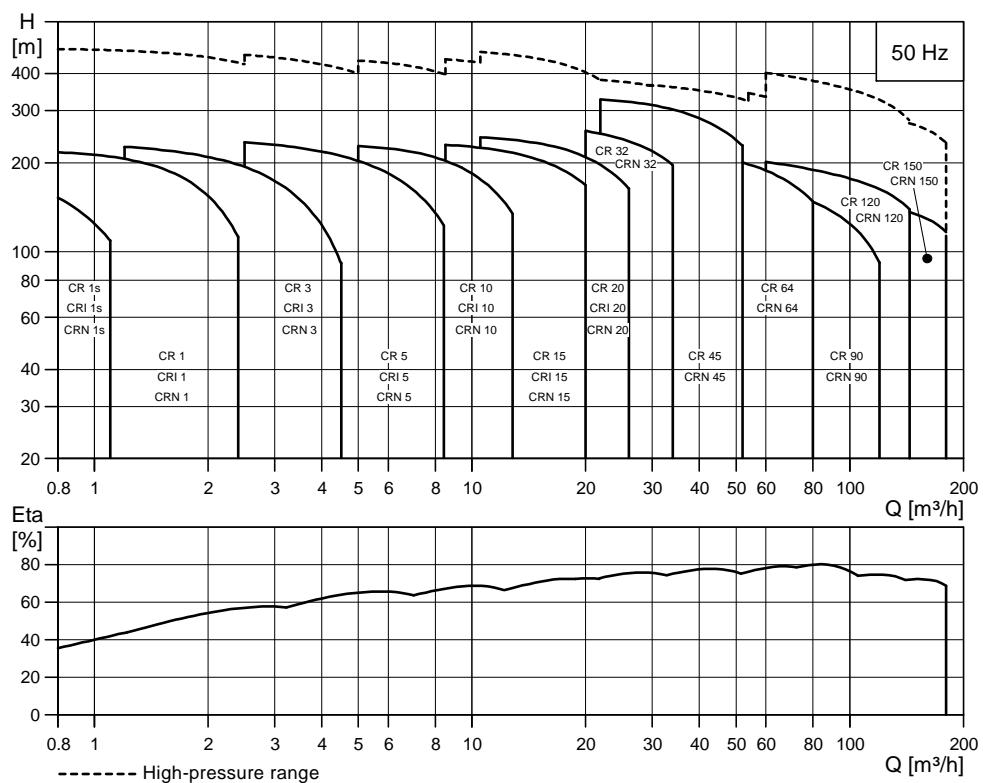

TM02 1192 4708

Performance range of CRE, CRIE, CRNE

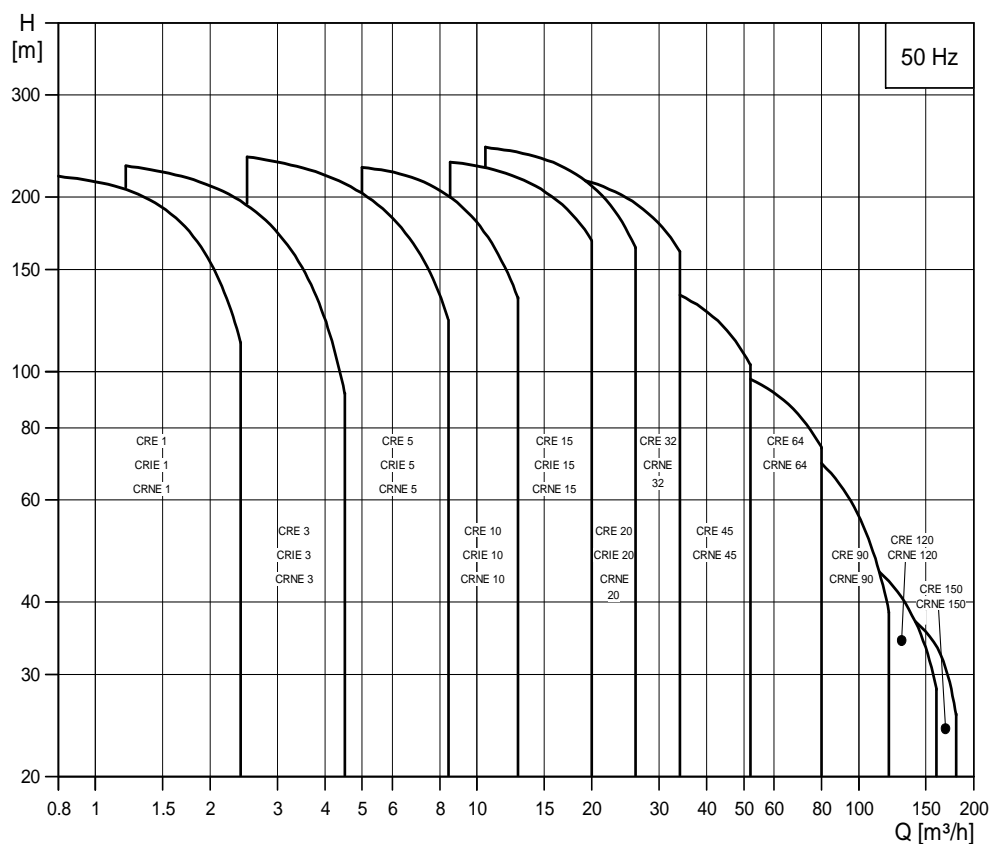

TM02 7281 4708

Applications

Application	CR, CRI	CRN	CRE, CRNE
Water supply			
Filtration and transfer at waterworks	●	○	●
Distribution from waterworks	●	○	●
Pressure boosting in mains	●	○	●
Pressure-boosting in high-rise buildings, hotels, etc.	●	○	●
Pressure-boosting for industrial water supply	●	○	●
Industry			
Pressure boosting			
Process-water systems	●	●	●
Washing and cleaning systems	●	●	○
Vehicle-washing tunnels	●	○	●
Fire-fighting systems	●	-	○
Liquid transfer			
Cooling and air-conditioning systems (refrigerants)	●	○	●
Boiler-feed and condensate systems	●	○	●
Machine tools (cooling lubricants)	●	●	●
Aquafarming*	●	○	-
Special transfer duties			
Oils and alcohols	●	●	-
Acids and alkalis*	-	●	-
Glycol and coolants	●	-	-
Water treatment			
Ultra-filtration systems	-	●	-
Reverse-osmosis systems*	-	●	-
Softening, ionising, demineralising systems	-	●	-
Distillation systems	-	●	-
Separators	●	●	●
Swimming baths*	-	●	-
Irrigation			
Field irrigation (flooding)	●	○	-
Sprinkler irrigation	●	○	●
Drip-feed irrigation	●	○	-

● Recommended version.

○ Alternative version.

* CRT, CRTE version available.

For further information about CRT, CRTE pumps, see section *Pumped liquids*, page 80, or related CRT, CRTE data booklet available on www.Grundfos.com (WebCAPS).

Product range

Range	CR 1s	CR, CRE 1	CR, CRE 3	CR, CRE 5	CR, CRE 10	CR, CRE 15	CR, CRE 20
Rated flow rate [m ³ /h]	0.8	1	3	5	10	15	20
Temperature range [°C]	-20 to +120						
Temperature range [°C], on request	-40 to +180						
Maximum pump efficiency [%]	35	48	58	66	70	72	72
CR pumps							
Flow range [m ³ /h]	0.3 - 1.1	0.7 - 2.4	1.2 - 4.5	2.5 - 8.5	5 - 13	9 - 24	11 - 29
Maximum pressure [bar]	21	22	24	24	22	23	25
High pressure [bar], on request	-	47	41	47	44	47	48
Motor power [kW]	0.37 - 1.1	0.37 - 2.2	0.37 - 3	0.37 - 5.5	0.37 - 7.5	1.1 - 15	1.1 - 18.5
CRE pumps							
Flow range [m ³ /h]	-	0.7 - 2.4	1.2 - 4.5	2.5 - 8.5	5 - 13	8.5 - 23.5	10.5 - 29
Maximum pressure [bar]	-	22	24	24	22	23	25
Motor power [kW]	-	0.37 - 2.2	0.37 - 3	0.37 - 5.5	0.37 - 7.5	1.1 - 15	1.1 - 18.5
Version							
CR, CRE: Cast iron and stainless steel EN 1.4301/AISI 304	•	•	•	•	•	•	•
CRI, CRIE: Stainless steel EN 1.4301/AISI 304	•	•	•	•	•	•	•
CRN, CRNE: Stainless steel EN 1.4401/AISI 316	•	•	•	•	•	•	•
CRT, CRTE: Titanium	See the CRT, CRTE data booklet.						
CR, CRE pipe connection							
Oval flange (BSP)	Rp 1	Rp 1	Rp 1	Rp 1 1/4	Rp 1 1/4	Rp 2	Rp 2
Oval flange (BSP), on request	Rp 1 1/4	Rp 1 1/4	Rp 1 1/4	Rp 1	Rp 1 1/4 Rp 2	Rp 2 1/2	Rp 2 1/2
Flange	DN 25/ DN 32	DN 25/ DN 32	DN 25/ DN 32	DN 25/ DN 32	DN 40	DN 50	DN 50
Flange, on request	-	-	-	-	DN 50	-	-
CRI, CRIE pipe connection							
Oval flange (BSP)	Rp 1	Rp 1	Rp 1 1/4	Rp 1 1/4	Rp 1 1/2	Rp 2	Rp 2
Oval flange (BSP), on request	Rp 1 1/4	Rp 1 1/4	Rp 1	Rp 1	Rp 2	-	-
Flange	DN 25/ DN 32	DN 25/ DN 32	DN 25/ DN 32	DN 25/ DN 32	DN 40	DN 50	DN 50
Flange, on request	-	-	-	-	DN 50	-	-
PJE coupling (Victaulic)	R 1 1/4 DN 32	R 1 1/4 DN 32	R 1 1/4 DN 32	R 1 1/4 DN 32	R 2 DN 50	R 2 DN 50	R 2 DN 50
Clamp coupling (L-coupling)	Ø48.3	Ø48.3	Ø48.3	Ø48.3	Ø60.3	Ø60.3	Ø60.3
Union (+GF+)	G 2	G 2	G 2	G 2	G 2 3/4	G 2 3/4	G 2 3/4
CRN(E) pipe connection							
Oval flange (BSP)	Rp 1	Rp 1	Rp 1 1/4	Rp 1 1/4	Rp 1 1/2	Rp 2	Rp 2
Oval flange (BSP), on request	Rp 1 1/4	Rp 1 1/4	Rp 1	Rp 1	Rp 2	-	-
Flange	DN 25/ DN 32	DN 25/ DN 32	DN 25/ DN 32	DN 25/ DN 32	DN 40	DN 50	DN 50
Flange, on request	-	-	-	-	DN 50	-	-
PJE coupling (Victaulic)	R 1 1/4 DN 32	R 1 1/4 DN 32	R 1 1/4 DN 32	R 1 1/4 DN 32	R 2 DN 50	R 2 DN 50	R 2 DN 50
Clamp coupling (L-coupling)	Ø48.3	Ø48.3	Ø48.3	Ø48.3	Ø60.3	Ø60.3	Ø60.3
Union (+GF+)	G 2	G 2	G 2	G 2	G 2 3/4	G 2 3/4	G 2 3/4

- Standard.
- Available.

Range	CR, CRE 32	CR, CRE 45	CR, CRE 64	CR, CRE 90	CR, CRE 120	CR, CRE 150
Rated flow rate [m ³ /h]	32	45	64	90	120	150
Temperature range [°C]	-30 to +120 ¹⁾			-30 to +120 ¹⁾ and 2)		
Temperature range [°C], on request	-40 to +180			-		
Maximum pump efficiency [%]	78	79	80	81	75	72
CR pumps						
Flow range [m ³ /h]	15 - 40	22 - 58	30 - 85	45 - 120	60 - 160	75 - 180
Maximum pressure [bar]	28	33	22	20	21	19
High pressure [bar], on request	39	39	39	41	41	39
Motor power [kW]	1.5 - 30	3 - 45	4 - 45	5.5 - 45	11 - 75	11 - 75
CRE pumps						
Flow range [m ³ /h]	15 - 40	22 - 58	30 - 85	45 - 120	60 - 160	75 - 180
Maximum pressure [bar]	28	26	20	20	6	5
Motor power [kW]	1.5 - 22	3 - 22	4 - 22	5.5 - 22	22	22
Version						
CR, CRE: Cast iron and stainless steel EN 1.4301/AISI 304	•	•	•	•	•	•
CRI, CRIE: Stainless steel EN 1.4301/AISI 304	○	○	○	○	-	-
CRN, CRNE: Stainless steel EN 1.4401/AISI 316	•	•	•	•	•	•
CRT, CRTE: Titanium	See the CRT, CRTE data booklet.				-	-
CR, CRE pipe connection						
Oval flange (BSP)	-	-	-	-	-	-
Oval flange (BSP), on request	-	-	-	-	-	-
Flange	DN 65	DN 80	DN 100	DN 100	DN 125	DN 125
Flange, on request	DN 80	DN 100	DN 125	DN 125	DN 150	DN 150
CRI, CRIE pipe connection						
Oval flange (BSP)	-	-	-	-	-	-
Oval flange (BSP), on request	-	-	-	-	-	-
Flange	-	-	-	-	-	-
Flange, on request	-	-	-	-	-	-
PJE coupling (Victaulic)	-	-	-	-	-	-
Clamp coupling (L-coupling)	-	-	-	-	-	-
Union (+GF+)	-	-	-	-	-	-
CRN(E) pipe connection						
Oval flange (BSP)	-	-	-	-	-	-
Oval flange (BSP), on request	-	-	-	-	-	-
Flange	DN 65	DN 80	DN 100	DN 100	DN 125	DN 125
Flange, on request	DN 80	DN 100	DN 125	DN 125	DN 150	DN 150
PJE coupling (Victaulic)	3" ²⁾	4" ³⁾	4" ³⁾	4" ³⁾	-	-
Clamp coupling (L-coupling)	-	-	-	-	-	-
Union (+GF+)	-	-	-	-	-	-

- Standard.
- Available.

¹⁾ CRN 32 to 150 with HQQE shaft seal: -40 °C to +120 °C.

²⁾ CR, CRN 120 and 150 with 55 or 75 kW motors with HBQE shaft seal: 0 °C to +120 °C.

³⁾ On request. See the CR "Custom-built pumps" catalogue available on www.grundfos.com (WebCAPS).

Pump

The CR and CRE pumps are non-self-priming, vertical multistage centrifugal pumps.

The pumps are available with a Grundfos standard motor (CR pumps) or a frequency-controlled motor (CRE pumps).

The pump consists of a base and a pump head. The chamber stack and the sleeve are secured between the pump head and the base by means of staybolts. The base has suction and discharge ports on the same level (in line). All pumps are fitted with a maintenance-free mechanical shaft seal of the cartridge type.

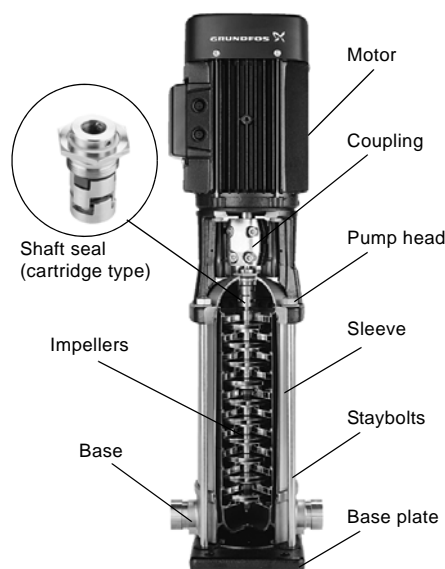

Fig. 3 CR pump

Motor

Grundfos standard motors, MG and Siemens

CR, CRI and CRN pumps are fitted with a totally enclosed, fan-cooled, 2-pole Grundfos standard motor with principal dimensions to EN standards.

Electrical tolerances according to EN 60034.

CR, CRI, CRN pumps are fitted with three-phase MG motors as standard.

CR, CRI, CRN pumps from 0.37 to 2.2 kW are also available with single-phase motors (1 x 220-230/240 V). See WinCAPS or WebCAPS.

Grundfos Blueflux®

Grundfos Blueflux® technology represents the best from Grundfos within energy-efficient motors and frequency converters. Grundfos Blueflux® solutions either meet or exceed legislative requirements such as the EuP IE3 grade.



TM04 9901 0211

Fig. 4 Grundfos Blueflux® label

Frequency-controlled motors, MGE

CRE, CRIE and CRNE pumps are fitted with a totally enclosed, fan-cooled, 2-pole frequency-controlled motor with principal dimensions to EN standards.

Electrical tolerances comply with EN 60034.

CRE, CRIE, CRNE pumps from 0.37 to 1.1 kW are fitted with single-phase MGE motors as standard.

CRE, CRIE, CRNE pumps from 0.75 to 1.1 kW are also available with three-phase MGE motors. See WinCAPS or WebCAPS.

Electrical data

	MG motor CR, CRI, CRN	MGE motor CRE, CRIE, CRNE
Mounting designation	Up to 4 kW: V 18 From 5.5 kW: V 1	
Insulation class	F	
Efficiency class	IE3	IE3 ¹⁾
	0.37 - 0.55 kW pumps are not part of the IE classification	
Enclosure class	IP55 ²⁾	IP54
Supply voltage (tolerance: ± 10 %)	P2: 0.37 - 1.5 kW: 3 x 220-240/380-415 V	P2: 0.37 - 1.1 kW: 1 x 200-240 V
	P2: 2.2 - 5.5 kW: 3 x 380-415 V	P2: 0.75 - 22 kW: 3 x 380-480 V
	P2: 7.5 - 75 kW: 3 x 380-415/660-690 V	
Supply frequency	50 Hz	50/60 Hz

¹⁾ Single-phase MGE motors are not part of the IE classification.

²⁾ IP44, IP54 and IP65 are available on request.

Optional motors

The Grundfos standard range of motors covers a wide variety of application demands. However, for special applications or operating conditions, custom-built motor solutions can be provided.

For special applications or operating conditions, Grundfos offers custom-built motors such as

- ATEX-approved motors
- MG motors with anti-condensation heating unit
- motors with thermal protection.

Motor protection

MG and Siemens motors

Single-phase Grundfos motors have a built-in thermal overload switch (IEC 34-11: TP 211).

Three-phase motors **must** be connected to a motor-protective circuit breaker according to local regulations.

Three-phase Grundfos motors as from 3 kW have a built-in thermistor (PTC) according to DIN 44082 (IEC 34-11: TP 211).

MGE motors

CRE, CRIE, CRNE pumps require no external motor protection. MGE motors incorporate thermal protection against slow overloading and blocking (IEC 34-11: TP 211).

Terminal box positions

As standard, the terminal box is fitted on the suction side of the pump.

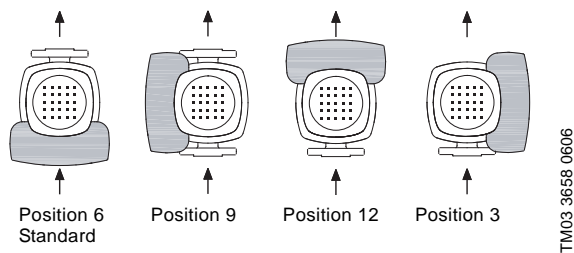

Fig. 5 Terminal box positions

Ambient temperature

Motor power [kW]	Motor make	Motor efficiency class	Maximum ambient temperature [°C]	Maximum altitude above sea level [m]
0.37 - 0.55	MG	-	+40	1000
0.75 - 22	MG	IE3	+60	3500
0.37 - 22	MGE	IE3	+40	1000
30 - 75	Siemens	IE3	+55	2750

If the ambient temperature exceeds the above maximum temperatures or the pump is installed at an altitude exceeding the above altitude values, the motor must not be fully loaded due to the risk of overheating. Overheating may result from excessive ambient temperatures or the low density and consequently low cooling effect of the air.

In such cases, it may be necessary to use a motor with a higher rated output.

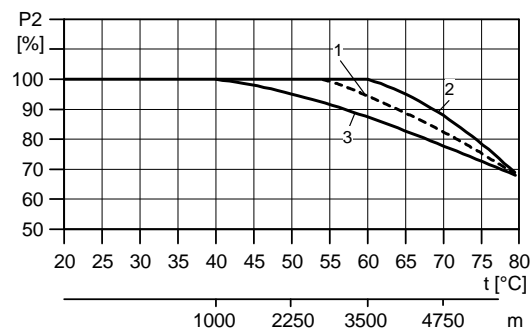

Fig. 6 Motor output depending on temperature/altitude

Pos.	Motor power [kW]	Motor make
1	0.37 - 0.55	MG
	0.37 - 22	MGE
2	0.75 - 22	MG
3	30 - 75	Siemens

Viscosity

The pumping of liquids with densities or kinematic viscosities higher than those of water will cause a considerable pressure drop, a drop in the hydraulic performance and a rise in the power consumption.

In such situations, the pump should be fitted with a larger motor. If in doubt, contact Grundfos.

2. Control of E-pumps

Examples of E-pump applications

CRE, CRIE and CRNE pumps are the ideal choice for a number of applications characterised by a demand for variable flow at constant pressure. The pumps are suited for water supply systems and pressure-boosting as well as for industrial applications.

Depending on the application, the pumps offer energy savings, increased comfort and improved processing.

E-pumps in the service of industry

The industry uses a large number of pumps in many different applications. Demands on pumps in terms of pump performance and mode of operation make speed control a must in many applications.

Below is listed some of the applications in which E-pumps are often used.

Constant pressure

- Water supply
- washing and cleaning systems
- distribution from waterworks
- humidifying systems
- water treatment systems
- process boosting systems, etc.

Example: Within industrial water supply, E-pumps with integrated pressure sensor are used to ensure a constant pressure in the piping system. From the sensor, the E-pump receives inputs about changes of pressure as a result of changes in the consumption. The E-pump responds to the input by adjusting the speed until the pressure is equalised. The constant pressure is stabilised once more on the basis of a preset setpoint.

Constant temperature

- Air-conditioning systems at industrial plants
- industrial cooling systems
- industrial freezing systems
- casting and moulding tools, etc.

Example: In industrial freezing systems, E-pumps with temperature sensor increase comfort and lower operating costs compared with pumps without a temperature sensor.

An E-pump continuously adapts its performance to the changing demands reflected in the differences in temperature of the liquid circulating in the freezing system. Thus, the lower the demand for cooling, the smaller the quantity of liquid circulated in the system and vice versa.

Constant flow

- Steam boiler systems
- condensate systems
- sprinkler irrigation systems
- chemical industry, etc.

Example: In a steam boiler, it is important to be able to monitor and control pump operation to maintain a constant level of water in the boiler.

By using an E-pump with level sensor in the boiler, it is possible to maintain a constant water level.

A constant water level ensures optimum and cost-efficient operation as a result of a stable steam production.

Dosing applications

- Chemical industry, i.e. control of pH values
- petrochemical industry
- paint industry
- degreasing systems
- bleaching systems, etc.

Example: In the petrochemical industry, E-pumps with pressure sensor are used as dosing pumps. The E-pumps help to ensure that the correct mixture ratio is achieved when more liquids are combined.

E-pumps functioning as dosing pumps improve processing and offer energy savings.

E-pumps in commercial building services

Commercial building services use E-pumps to maintain a constant pressure or a constant temperature based on a variable flow.

Constant pressure

Water supply in high-rise buildings such as office buildings and hotels.

Example: E-pumps with pressure sensor are used for water supply in high-rise buildings to ensure a constant pressure even at the highest draw-off point. As the consumption pattern and thus the pressure changes during the day, the E-pump continuously adapts its performance until the pressure is equalised.

Constant temperature

- Air-conditioning systems in hotels, schools, etc.
- building cooling systems, etc.

Example: E-pumps are an excellent choice for buildings where a constant temperature is essential. E-pumps keep the temperature constant in air-conditioned, high-rise glass buildings, irrespective of the seasonal fluctuations of the outdoor temperature and various heat impacts inside the building.

Control options of E-pumps

Communication with CRE, CRIE, CRNE pumps is possible by means of either of the following:

- a central management system
- remote control (Grundfos R100)
- a control panel.

The purpose of controlling an E-pump is to monitor and control the pressure, temperature, flow and liquid level of the system.

Central management system

Communication with the E-pump is possible even if the operator is not present near the E-pump. Communication is enabled by connecting the E-pump to a central management system. This allows the operator to monitor the pump and to change control modes and setpoint settings.

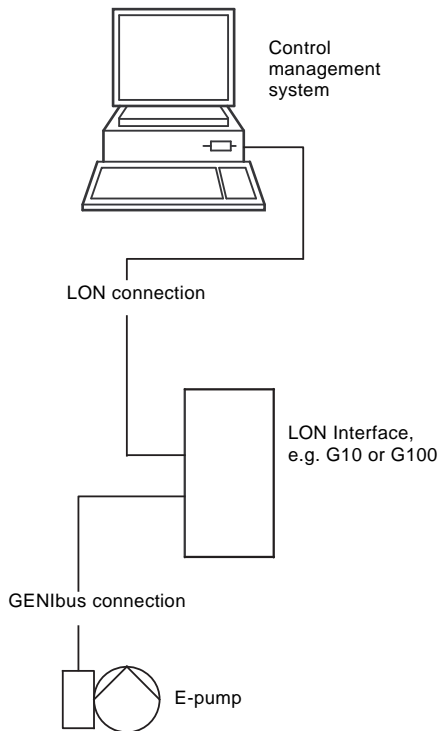

Fig. 7 Structure of a central management system

TM02 6592 1404

Remote control

The Grundfos R100 remote control is available as an accessory.

The operator communicates with the E-pump by pointing the R100 at the control panel of the E-pump terminal box.

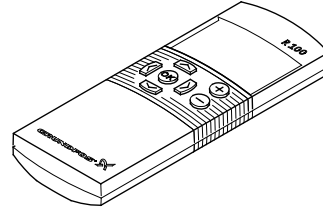

TM00 4498 2802

Fig. 8 R100 remote control

With the R100 it is possible to monitor and change control modes and settings of the E-pump.

Control panel

The control panel of the E-pump terminal box makes it possible to change the setpoint settings manually.

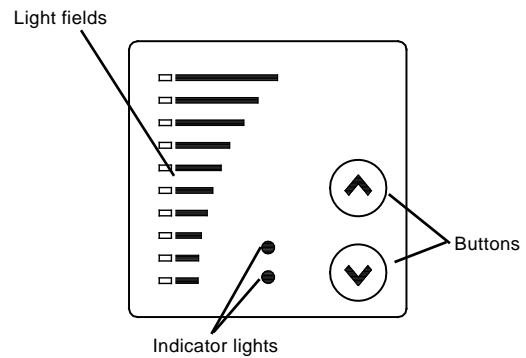

TM00 7600 0404

Fig. 9 Control panel on CRE pump

Control modes for E-pumps

Grundfos offers CRE, CRIE and CRNE pumps in two different variants:

- CRE, CRIE and CRNE with integrated pressure sensor
- CRE, CRIE and CRNE without sensor.

CRE, CRIE, CRNE with integrated pressure sensor

Use CRE, CRIE and CRNE pumps with integrated pressure sensor in applications where you want to control the pressure after the pump, irrespective of the flow.

For further information, see section *Examples of E-pump applications*, page 10.

Signals of pressure changes in the piping system are transmitted continuously from the sensor to the pump. The pump responds to the signals by adjusting its performance up or down to compensate for the pressure difference between the actual and the desired pressure. As this adjustment is a continuous process, a constant pressure is maintained in the piping system.



Fig. 10 CRE, CRIE and CRNE pumps

A CRE, CRIE or CRNE pump with integrated pressure sensor facilitates installation and commissioning.

CRE, CRIE and CRNE pumps with integrated pressure sensor can be set to either of these control modes:

- constant pressure (factory setting)
- constant curve.

In **constant-pressure** mode, the pump maintains a preset pressure after the pump, irrespective of the flow. See fig. 11.

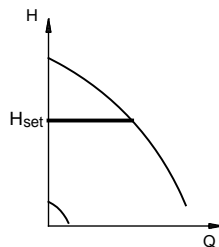

Fig. 11 Constant-pressure mode

In **constant-curve** mode, the pump is not controlled. It can be set to pump according to a preset pump characteristic within the range from min. curve to max. curve. See fig. 12.

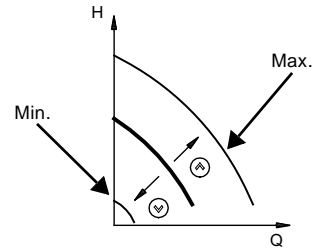

Fig. 12 Constant-curve mode

CRE, CRIE and CRNE without sensor

CRE, CRIE and CRNE pumps without sensor are suitable in these situations

- where uncontrolled operation is required.
- where you want to fit another sensor later in order to control the flow, temperature, differential temperature, liquid level, pH value, etc. at some arbitrary point in the system.

CRE, CRIE and CRNE pumps without sensor can be set to either of these control modes:

- controlled operation
- uncontrolled operation (factory-setting).

In **controlled**-operation mode, the pump adjusts its performance to the desired setpoint. See fig. 13.

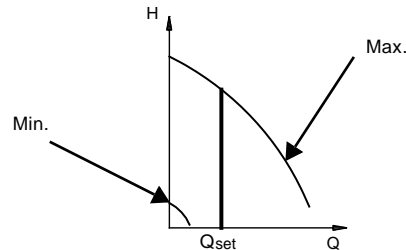

Fig. 13 Constant-flow mode

In **uncontrolled**-operation mode, the pump operates according to the constant curve set. See fig. 14.

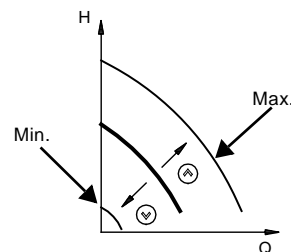

Fig. 14 Constant-curve mode

CRE, CRIE and CRNE pumps can be fitted with sensor types meeting the requirements mentioned in the data booklet titled "Grundfos E-pumps" available on www.Grundfos.com (WebCAPS).

TM00 9323 1204

TM02 7398 3403

TM02 7264 2803

TM00 9322 4796

TM00 9323 1204

3. Construction

CR(E) 1s, 1, 3, 5, 10, 15 and 20



TM02 1198 0601 - GR7377 - GR7379

Sectional drawing

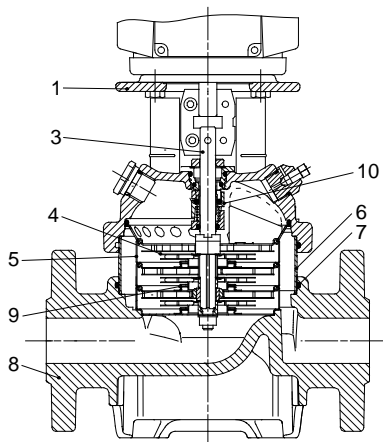

TM02 1194 1403

Materials, CR(E)

Pos.	Designation	Materials	EN/DIN	AISI/ASTM
1	Pump head	Cast iron EN-GJL-200	EN-JL1030	ASTM 25B
3	Shaft	Stainless steel	1.4401 ¹⁾ 1.4057 ²⁾	AISI 316 AISI 431
4	Impeller	Stainless steel	1.4301	AISI 304
5	Chamber	Stainless steel	1.4301	AISI 304
6	Sleeve	Stainless steel	1.4301	AISI 304
7	O-ring for sleeve	EPDM or FKM		
8	Base	Cast iron EN-GJL-200	EN-JL1030	ASTM 25B
9	Neck ring	PTFE		
10	Shaft seal			
	Rubber parts	EPDM or FKM		

¹⁾ CR(E) 1S, 1, 3, 5.

²⁾ CR(E) 10, 15, 20.

CRI(E), CRN(E) 1s, 1, 3, 5, 10, 15 and 20



TM02 1808 2001 - GR7373 - GR7375

Sectional drawing

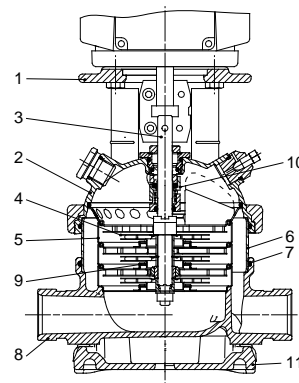

TM02 1195 1403

Materials, CRI(E) and CRN(E)

Pos.	Designation	Materials	EN/DIN	AISI/ASTM
1	Pump head	Cast iron EN-GJL-200 ¹⁾	EN-JL1030	ASTM 25B
2	Pump head cover	Stainless steel	1.4408	CF 8M equal to AISI 316
3	Shaft	Stainless steel	1.4401 ²⁾ 1.4460 ³⁾	AISI 316 AISI 329
8	Base	Stainless steel	1.4408	CF 8M equal to AISI 316
9	Neck ring	PTFE		
10	Shaft seal	Cartridge type		
11	Base plate	Cast iron EN-GJL-200 ¹⁾	EN-JL1030	ASTM 25B
	Rubber parts	EPDM or FKM		
CRI(E)				
4	Impeller	Stainless steel	1.4301	AISI 304
5	Chamber	Stainless steel	1.4301	AISI 304
6	Sleeve	Stainless steel	1.4301	AISI 304
7	O-ring for sleeve	EPDM or FKM		
CRN(E)				
4	Impeller	Stainless steel	1.4401	AISI 316
5	Chamber	Stainless steel	1.4401	AISI 316
6	Sleeve	Stainless steel	1.4401	AISI 316
7	O-ring for sleeve	EPDM or FKM		

¹⁾ Stainless steel available on request.

²⁾ CRI(E), CRN(E) 1S, 1, 3, 5.

³⁾ CRI(E), CRN(E) 10, 15, 20.

CR(E) 32, 45, 64 and 90



TM01 2150 1298 - GRA4355

Sectional drawing

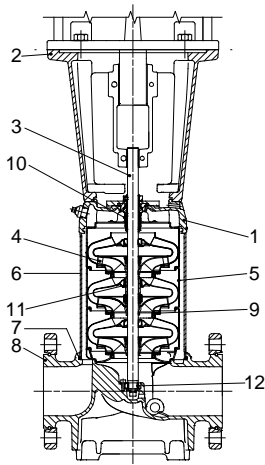

TM01 1836 1403

Materials, CR(E)

Pos.	Designation	Materials	EN/DIN	AISI/ASTM
1	Pump head	Cast iron EN-GJS-500-7	EN-JS1050	ASTM 80-55-06
2	Motor stool	Cast iron EN-GJL-200	EN-JL1030	ASTM 25B
3	Shaft	Stainless steel	1.4057	AISI 431
4	Impeller	Stainless steel	1.4301	AISI 304
5	Chamber	Stainless steel	1.4301	AISI 304
6	Sleeve	Stainless steel	1.4301	AISI 304
7	O-ring for sleeve	EPDM or FKM		
8	Base	Cast iron EN-GJS-500-7	EN-JS1050	ASTM 80-55-06
9	Neck ring	Carbon-graphite-filled PTFE		
10	Shaft seal			
11	Bearing ring	Bronze		
12	Bottom bearing ring	Tungsten carbide/tungsten carbide		
	Rubber parts	EPDM or FKM		

CRN(E) 32, 45, 64 and 90



TM02 7399 3403

Sectional drawing

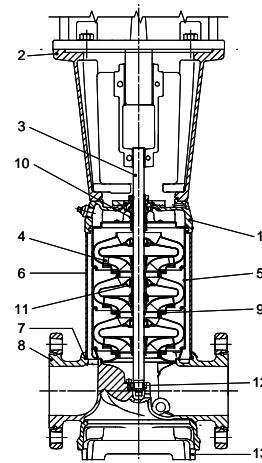

TM01 1837 1403

Materials, CRN(E)

Pos.	Designation	Materials	EN/DIN	AISI/ASTM
1	Pump head	Stainless steel	1.4408	CF 8M equal to AISI 316
2	Motor stool	Cast iron EN-GJL-200 ¹⁾	EN-JL1030	ASTM 25B
3	Shaft	Stainless steel	1.4462	
4	Impeller	Stainless steel	1.4401	AISI 316
5	Chamber	Stainless steel	1.4401	AISI 316
6	Sleeve	Stainless steel	1.4401	AISI 316
7	O-ring for sleeve	EPDM or FKM		
8	Base	Stainless steel	1.4408	CF 8M equal to AISI 316
9	Neck ring	Carbon-graphite filled PTFE		
10	Shaft seal			
11	Bearing ring	Carbon-graphite filled PTFE		
12	Bottom bearing ring	Tungsten carbide/tungsten carbide		
13	Base plate	Cast iron EN-GJS-500-7 ¹⁾	EN-JS1050	ASTM 88-55-06
	Rubber parts	EPDM or FKM		

¹⁾ Stainless steel available on request.

CR(E) 120 and 150



GrA3731

Sectional drawing

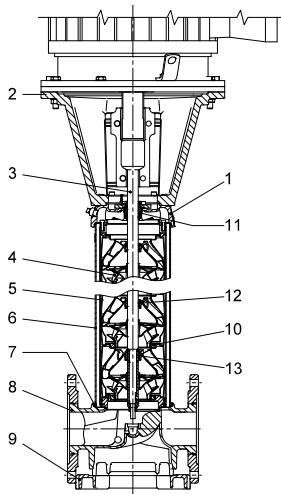

TM03 8836 2607

Materials, CR(E)

Pos.	Designation	Materials	EN/DIN	AISI/ASTM
1	Pump head	Cast iron EN-GJS-500-7	EN-JS1050	A 536 65-45-12
2	Motor stool (11-45 kW)	Cast iron EN-GJL-200	EN-JL1030	A48-30 B
	Motor stool (55-75 kW)	Cast iron EN-GJS-500-7	EN-JS1050	A 536 65-45-12
3	Shaft	Stainless steel	1.4057	AISI 431
4	Impeller	Stainless steel	1.4301	AISI 304
5	Chamber	Stainless steel	1.4301	AISI 304
6	Sleeve	Stainless steel	1.4401	AISI 316
7	O-ring for sleeve	EPDM or FKM		
8	Base	Cast iron EN-GJS-500-7	EN-JS1050	A 536 65-45-12
9	Base plate	Cast iron EN-GJS-500-7	EN-JS1050	A 536 65-45-12
10	Neck ring	PTFE		
11	Shaft seal ¹⁾	SiC/SiC (Ø22) Carbon/SiC (Ø32)		
12	Support bearing	PTFE		
13	Bearing ring	SiC/SiC		
	Rubber parts	EPDM or FKM		

¹⁾ Ø22 mm shaft, 11-45 kW. Ø32 mm shaft, 55-75 kW.

CRN(E) 120 and 150



GrA3732 - GrA3735

Sectional drawing

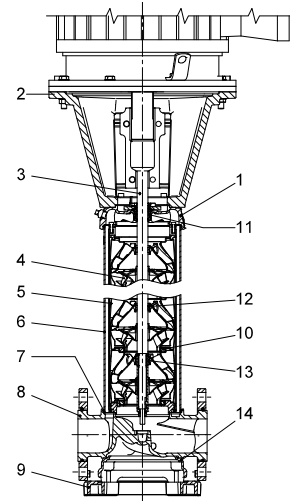

TM03 8836 2607

Materials, CRN(E)

Pos.	Designation	Materials	EN/DIN	AISI/ASTM
1	Pump head	Stainless steel	1.4408	A 351 CF 8M
2	Motor stool (11-45 kW)	Cast iron EN-GJL-200	EN-JL1030	A48-30 B
	Motor stool (55-75 kW)	Cast iron EN-GJS-500-7	EN-JS1050	A 536 65-45-12
3	Shaft	Stainless steel	1.4462	SAF 2205
4	Impeller	Stainless steel	1.4401	AISI 316
5	Chamber	Stainless steel	1.4401	AISI 316
6	Sleeve	Stainless steel	1.4401	AISI 316
7	O-ring for sleeve	EPDM or FKM		
8	Base	Stainless steel	1.4408	A 351 CF 8M
9	Base plate	Cast iron EN-GJS-500-7 ¹⁾	EN-JS1050	A 536 65-45-12
10	Neck ring	PTFE		
11	Shaft seal ²⁾	SiC/SiC (Ø22) Carbon/SiC (Ø32)		
12	Support bearing	PTFE		
13	Bearing ring	SiC/SiC		
14	Base plate	Cast iron EN-GJS-500-7 ¹⁾	EN-JS1050	A 536 65-45-12
	Rubber parts	EPDM or FKM		

¹⁾ Stainless steel available on request.

²⁾ Ø22 mm shaft, 11-45 kW.
Ø32 mm shaft, 55-75 kW.

Type keys

CR(E), CRI(E), CRN(E)

Example	CR E 32 (s) -4 -2 -A -F -G -E -HQQE
Type range: CR, CRI, CRN	
Pump with integrated frequency converter	
Flow rate [m ³ /h]	
All impellers with reduced diameter (applies only to CR, CRI, CRN 1s)	
Number of impellers	
Number of reduced-diameter impellers (CR(E), CRN(E) 32, 45, 64, 90, 120 and 150)	
Code for pump version	
Code for pipe connection	
Code for materials	
Code for rubber parts	
Code for shaft seal	

Codes

Example	A -F -A -E -H QQ E
Pump version	
A Basic version	
B Oversize motor	
E Pump with certificate/approval	
F CR pump for high temperatures (air-cooled top assembly)	
H Horizontal version	
HS High-pressure pump with high-speed MGE motor	
I Different pressure rating	
J Pump w/different max. speed	
K Pump with low NPSH	
M Magnetic drive	
N Fitted with sensor	
P Undersize motor	
R Horizontal version with bearing bracket	
SF High-pressure pump	
X Special version	
Pipe connection	
A Oval flange	
B NPT thread	
CA FlexiClamp (CRI(E), CRN(E) 1, 3, 5, 10, 15, 20)	
F DIN flange	
G ANSI flange	
J JIS flange	
N Changed diameter of ports	
P PJE coupling	
X Special version	
Materials	
A Basic version	
D Carbon-graphite-filled PTFE (bearings)	
G Wetted parts of 1.4401/AISI 316	
GI All parts of stainless steel, wetted parts of 1.4401/AISI 316	
I Wetted parts of 1.4301/AISI 304	
II All parts of stainless steel, wetted parts of 1.4301/AISI 304	
K Bronze (bearings)	
S SiC bearings + PTFE neck rings	
X Special version	
Code for rubber parts	
E EPDM	
F FXM	
K FFKM	
V FKM	
Shaft seal	
H Balanced cartridge seal	
Q Silicon carbide	
U Tungsten carbide	
B Carbon	
E EPDM	
F FXM	
K FFKM	
V FKM	

4. Operating and inlet pressures

Maximum operating pressure and liquid temperature

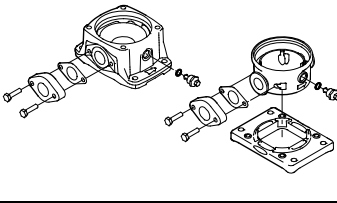
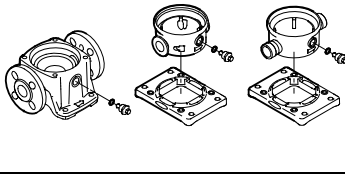
	Oval flange		PJE, clamp, union, DIN	
				
	Maximum permissible operating pressure	Liquid temperature	Maximum permissible operating pressure	Liquid temperature
	[bar]	[°C]	[bar]	[°C]
CR, CRI, CRN 1s	16	-20 to +120	25	-20 to +120
CR(E), CRI(E), CRN(E) 1	16	-20 to +120	25	-20 to +120
CR(E), CRI(E), CRN(E) 3	16	-20 to +120	25	-20 to +120
CR(E), CRI(E), CRN(E) 5	16	-20 to +120	25	-20 to +120
CR(E), CRI(E) 10-1 → 10-16	16	-20 to +120	16	-20 to +120
CR(E), CRI(E) 10-17 → 10-22	-	-	25	-20 to +120
CRN(E) 10	-	-	25	-20 to +120
CR(E), CRI(E) 15-1 → 15-7	10	-20 to +120	-	-
CR(E), CRI(E) 15-1 → 15-10	-	-	16	-20 to +120
CR(E), CRI(E) 15-12 → 15-17	-	-	25	-20 to +120
CRN(E) 15	-	-	25	-20 to +120
CR(E), CRI(E) 20-1 → 20-7	10	-20 to +120	-	-
CR(E), CRI(E) 20-1 → 20-10	-	-	16	-20 to +120
CR(E), CRI(E) 20-12 → 20-17	-	-	25	-20 to +120
CRN(E) 20	-	-	25	-20 to +120
CR(E), CRN(E) 32-1-1 → 32-7	-	-	16	-30 to +120
CR(E), CRN(E) 32-8-2 → 32-14	-	-	30	-30 to +120
CR(E), CRN(E) 45-1-1 → 45-5	-	-	16	-30 to +120
CR(E), CRN(E) 45-6-2 → 45-11	-	-	30	-30 to +120
CR, CRN 45-12-2 → 45-13-2	-	-	33	-30 to +120
CR(E), CRN(E) 64-1-1 → 64-5	-	-	16	-30 to +120
CR, CRN 64-6-2 → 64-8-1	-	-	30	-30 to +120
CR(E), CRN(E) 90-1-1 → 90-4	-	-	16	-30 to +120
CR, CRN 90-5-2 → 90-6	-	-	30	-30 to +120
CR(E), CRN(E) 120	-	-	30	-30 to +120
CR(E), CRN(E) 150	-	-	30	-30 to +120

Operating range of the shaft seal

The operating range of the shaft seal depends on operating pressure, pump type, type of shaft seal and liquid temperature. The following curves apply to clean water and water with anti-freeze liquids. For selection of the right shaft seal, see section *List of pumped liquids*, page 80. If the operating range is exceeded, the life of the shaft seal may be reduced.

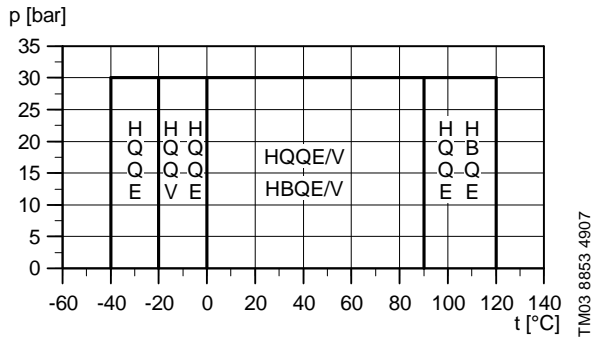

Fig. 15 Operating range of standard shaft seals

Standard shaft seal	Motor size [kW]	Description	Temperature range [°C]
HQQE	0.37 - 45	O-ring (cartridge) (balanced seal), SiC/SiC, EPDM	-40 to +120
HBQE ¹⁾	55 - 75	O-ring (cartridge) (balanced seal), carbon/SiC, EPDM	0 to +120
HQQV	0.37 - 45	O-ring (cartridge) (balanced seal), SiC/SiC, FKM	-20 to +90
HBQV ¹⁾	55 - 75	O-ring (cartridge) (balanced seal), carbon/SiC, FKM	0 to +90

¹⁾ Available as HQQE and HQQV on request.

See section *Lists of variants*, page 91, in case of extreme temperatures:

- low temperatures down to -40 °C
- high temperatures up to +180 °C.

Maximum inlet pressure

The following table shows the maximum permissible inlet pressure. However, the actual inlet pressure + the pressure against a closed valve **must** always be lower than the maximum permissible operating pressure.

If the maximum permissible operating pressure is exceeded, the conical bearing in the motor may be damaged and the life of the shaft seal reduced.

Pump type	Maximum inlet pressure [bar]
CR, CRI, CRN 1s	
1s-2 → 1s-36	10
CR(E), CRI(E), CRN(E) 1	
1-2 → 1-36	10
CR(E), CRI(E), CRN(E) 3	
3-2 → 3-29	10
3-31 → 3-36	15
CR(E), CRI(E), CRN(E) 5	
5-2 → 5-16	10
5-18 → 5-36	15
CR(E), CRI(E), CRN(E) 10	
10-1 → 10-6	8
10-7 → 10-22	10
CR(E), CRI(E), CRN(E) 15	
15-1 → 15-3	8
15-4 → 15-17	10
CR(E), CRI(E), CRN(E) 20	
20-1 → 20-3	8
20-4 → 20-17	10
CR(E), CRN(E) 32	
32-1-1 → 32-4	4
32-5-2 → 32-10	10
32-11-2 → 32-14	15
CR(E), CRN(E) 45	
45-1-1 → 45-2	4
45-3-2 → 45-5	10
45-6-2 → 45-13-2	15
CR(E), CRN(E) 64	
64-1-1 → 64-2-2	4
64-2-1 → 64-4-2	10
64-4-1 → 64-8-1	15
CR(E), CRN(E) 90	
90-1-1 → 90-1	4
90-2-2 → 90-3-2	10
90-3 → 90-6	15
CR(E), CRN(E) 120	
120-1 → 120-2-1	10
120-2 → 120-5-1	15
120-6-1 → 120-7	20
CR(E), CRN(E) 150	
150-1-1 → 150-1	10
150-2-1 → 150-4-1	15
150-5-2 → 150-6	20

Examples of operating and inlet pressures

The values for operating and inlet pressures shown in the table should not be considered individually but should always be compared. See the following examples.

Example 1

The following pump type has been selected:
CR 5-16 A-A-A.

Maximum operating pressure: **10 bar**.

Maximum inlet pressure: **10 bar**.

Discharge pressure against a closed valve: **10.6 bar**.
See page 39.

This pump is not allowed to start at an inlet pressure of 10 bar, but at an inlet pressure of $16.0 - 10.6 = 5.4$ bar.

Example 2

The following pump type has been selected:
CR 10-2 A-A-A.

Maximum operating pressure: **16 bar**.

Maximum inlet pressure: **8.0 bar**.

Discharge pressure against a closed valve: **2.0 bar**.
See page 43.

This pump is allowed to start at an inlet pressure of 8.0 bar, as the discharge pressure against a closed valve is only 2.0 bar, which results in an operating pressure of $8.0 + 2.0 = 10.0$ bar. On the contrary, the maximum operating pressure of this pump is limited to 16.0 bar as a higher operating pressure will require an inlet pressure of more than 8.0 bar.

If the inlet or operating pressure exceeds the pressure permitted, see section *Lists of variants*, page 91.

5. Selection and sizing

Selection of pumps

Selection of pumps should be based on these elements:

- the duty point of the pump (see page 20)
- dimensional data such as pressure loss as a result of height differences, friction loss in the pipework, pump efficiency, etc. (see page 20)
- pump materials (see page 22)
- pump connections (see page 22)
- shaft seal (see page 22).

Duty point of the pump

From a duty point it is possible to select a pump on the basis of the curve charts shown in section 6. *Performance curves/technical data*, pages 26 to 77.

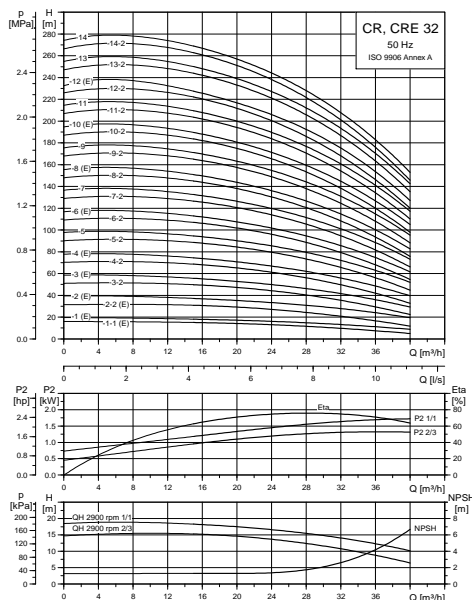

Fig. 16 Example of a curve chart

Dimensional data

When sizing a pump, take the following factors into account:

- Required flow and pressure at the draw-off point.
- Pressure loss as a result of height differences (H_{geo}).
- Friction loss in the pipework (H_f).
It may be necessary to account for pressure loss in connection with long pipes, bends or valves, etc.
- Best efficiency at the estimated duty point.
- NPSH value.
For calculation of the NPSH value, see section *Minimum inlet pressure, NPSH*, page 23.

Pump efficiency

Before determining the best efficiency point, the operation pattern of the pump needs to be identified. If the pump is expected to operate at the **same** duty point, select a CR pump which is operating at a duty point corresponding with the best efficiency of the pump.

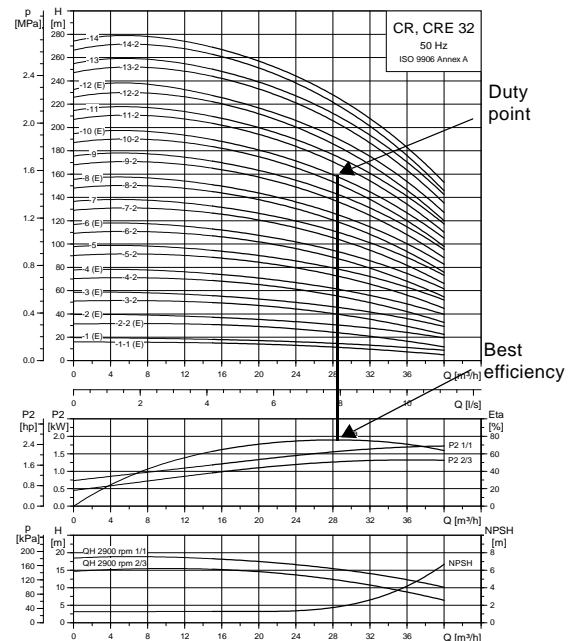

Fig. 17 Example of a CR pump's duty point

As the pump is sized on the basis of the highest possible flow, it is important always to have the duty point to the right on the efficiency curve (eta) in order to keep the efficiency high when the flow drops.

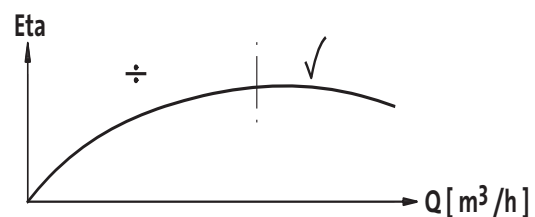

Fig. 18 Best efficiency

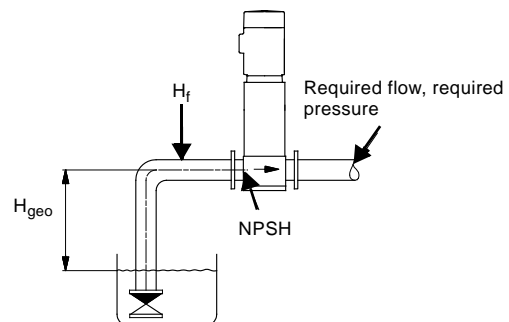

Fig. 19 Dimensional data

Normally, E-pumps are used in applications characterised by a **variable** flow. Consequently, it is not possible to select a pump that is constantly operating at optimum efficiency.

In order to achieve optimum operating economy, the pump should be selected on the basis of the following criteria:

- The max. duty point required should be as close as possible to the QH curve of the pump.
- The flow rate at the duty point required should be close to the optimum efficiency (eta) for most operating hours.

Between the min. and max. performance curves, E-pumps have an infinite number of performance curves, each representing a specific speed. Therefore, it may not be possible to select a duty point close to the 100 % curve.

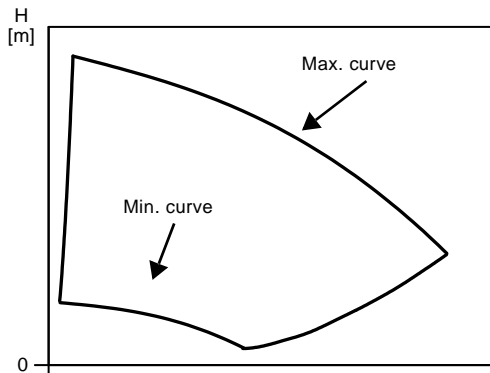

Fig. 20 Min. and max. performance curves

In situations where it is not possible to select a duty point close to the 100 % curve, the below affinity equations can be used. The head (H), the flow (Q) and the input power (P) are all the appropriate variables for the motor speed (n).

Note

The approximated formulas apply on condition that the system characteristic remains unchanged for n_n and n_x and that it is based on the formula $H = k \times Q^2$ where k is a constant.

The power equation implies that the pump efficiency is unchanged at the two speeds. In practice, this is **not** quite correct.

To obtain a precise calculation of the power savings resulting from a reduction of pump speed, take into account the efficiencies of the frequency converter and the motor.

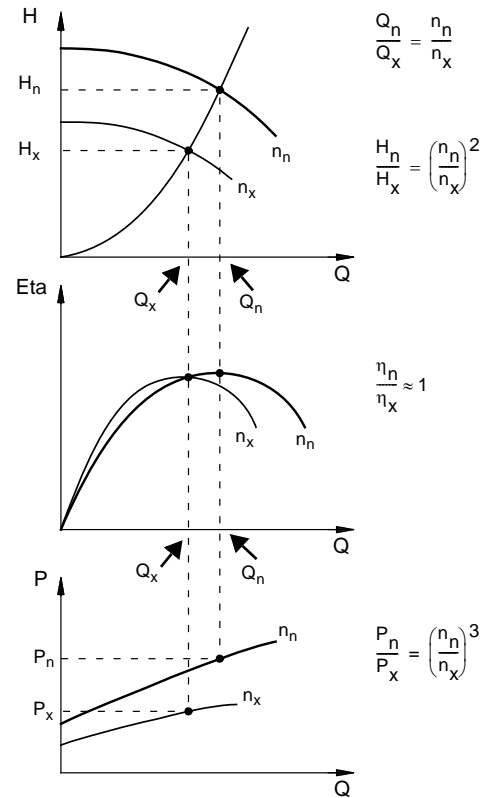

Fig. 21 Affinity equations

Legend

- H_n Rated head in metres.
- H_x Current head in metres.
- Q_n Rated flow in m^3/h .
- Q_x Current flow in m^3/h .
- n_n Rated motor speed in min^{-1} ($n_n = 2900 min^{-1}$).
- n_x Current motor speed in min^{-1} .
- η_n Rated efficiency in %.
- η_x Current efficiency in %.

WinCAPS and WebCAPS

WinCAPS and WebCAPS are both selection programmes offered by Grundfos.

The two programmes make it possible to calculate an E-pump's specific duty point and energy consumption.

By entering the dimensional data of the pump, WinCAPS and WebCAPS can calculate the exact duty point and energy consumption.

For further information, see pages 92 and 93.

TM00 8720 3496

TM01 4916 4803

Pump material

Select the material variant (CR(E), CRI(E), CRN(E)) on the basis of the liquid to be pumped.

The product range covers the following three basic types.

- CR(E), CRI(E)
Use CR(E), CRI(E) pumps for clean, non-aggressive liquids such as potable water and oils.
- CRN(E)
Use CRN(E) pumps for industrial liquids and acids. See section *List of pumped liquids*, page 80, or contact Grundfos.

For saline or chloride-containing liquids such as sea water, CRT(E) pumps of titanium are available.

Pump connections

Selection of pump connection depends on the rated pressure and pipework. To meet any requirement, the CR(E), CRI(E) and CRN(E) pumps offer a wide range of flexible connections such as

- oval flange (BSP)
- DIN flange
- PJE coupling
- clamp coupling
- union (+GF+)
- other connections on request.

Shaft seal

As standard, the CR(E) range is fitted with a Grundfos shaft seal (cartridge type) suitable for the most common applications.

These key parameters **must** be taken into account when selecting the shaft seal:

- type of pumped liquid
- liquid temperature
- maximum pressure.

Grundfos offers a wide range of shaft seal variants to meet specific demands. See section *List of pumped liquids*, page 80.

Operating pressure and inlet pressure

Do **not** exceed the limit values stated on pages 17 and 19 for these pressures:

- maximum operating pressure
- maximum inlet pressure.

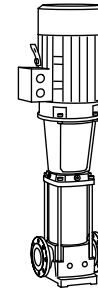

Fig. 22 CR pump

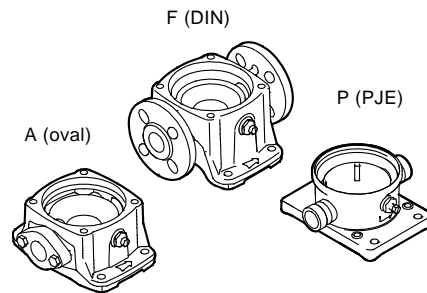

Fig. 23 Pump connections

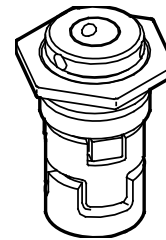

Fig. 24 Shaft seal (cartridge type)

TM01 2100 1198

TM02 1201 0601

TM02 0538 4800

Minimum inlet pressure, NPSH

Calculation of the inlet pressure "H" is recommended in these situations:

- The liquid temperature is high.
- The flow is significantly higher than the rated flow.
- Water is drawn from depths.
- Water is drawn through long pipes.
- Inlet conditions are poor.

To avoid cavitation, make sure that there is a minimum pressure on the suction side of the pump.

The maximum suction lift "H" in metres head can be calculated as follows:

$$H = p_b \times 10.2 - \text{NPSH} - H_f - H_v - H_s$$

p_b	=	Barometric pressure in bar. (Barometric pressure can be set to 1 bar). In closed systems, p_b indicates the system pressure in bar.
NPSH	=	Net Positive Suction Head in metres head. (To be read from the NPSH curve at the highest flow the pump will be delivering.)
H_f	=	Friction loss in suction pipe in metres head. (At the highest flow the pump will be delivering.)
H_v	=	Vapour pressure in metres head. (To be read from the vapour pressure scale. H_v depends on the liquid temperature t_m .)
H_s	=	Safety margin = minimum 0.5 metres head.

If the calculated "H" is positive, the pump can operate at a suction lift of maximum "H" metres head.

If the calculated "H" is negative, an inlet pressure of minimum "H" metres head is required.

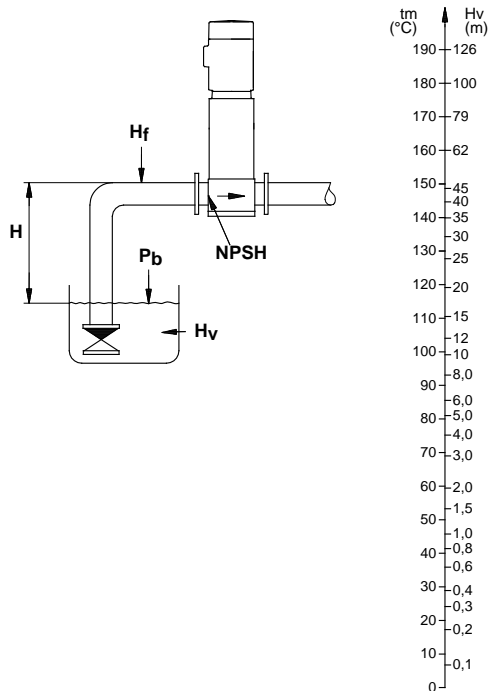

TM02 7439 3403

Fig. 25 Minimum inlet pressure, NPSH

Note: To avoid cavitation, **never** select a pump with a duty point too far to the right on the NPSH curve.

Always check the NPSH value of the pump at the highest possible flow.

How to read the curve charts

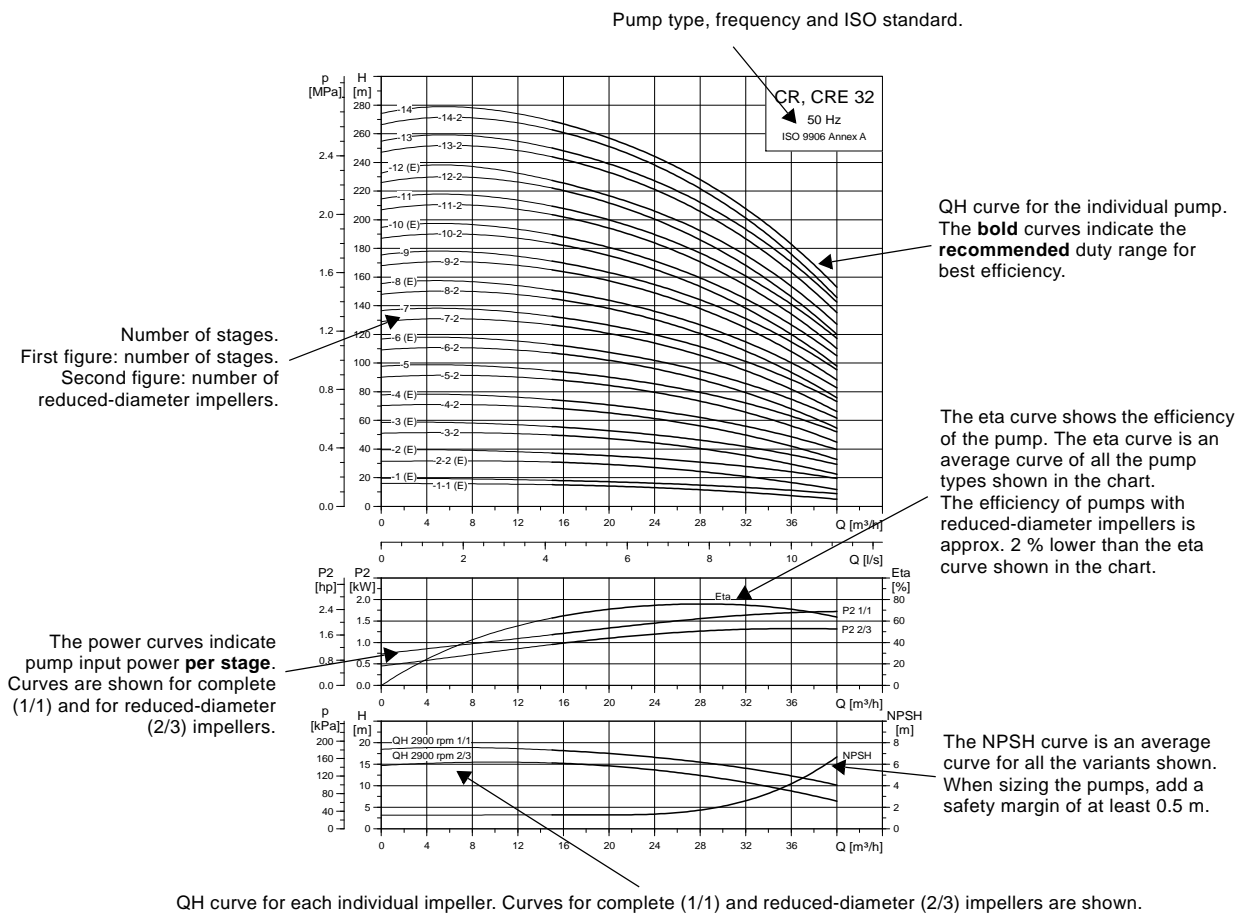

QH curve for each individual impeller. Curves for complete (1/1) and reduced-diameter (2/3) impellers are shown.

Fig. 26 How to read the curve charts

Guidelines to performance curves

The guidelines below apply to the curves shown on the following pages:

- Tolerances to ISO 9906, Annex A, if indicated.
- The motors used for the measurements are standard Grundfos motors (MG or MGE).
- Measurements have been made with airless water at a temperature of 20 °C.
- The curves apply to the following kinematic viscosity: $\nu = 1 \text{ mm}^2/\text{s}$ (1 cSt).
- Due to the risk of overheating, the pumps should not be used at a flow below the minimum flow rate.
- The QH curves apply to a rated motor speed of 2900 min^{-1} . All curves are based on current motor speeds.

The curve below shows the minimum flow rate as a percentage of the rated flow rate in relation to the liquid temperature. The dotted line shows a CR pump fitted with an air-cooled top assembly.

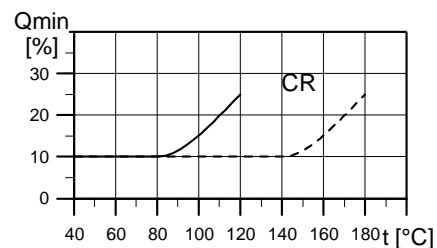

Fig. 27 Minimum flow rate

TM02 7302 3103

TM01 2816 0303

6. Performance curves/technical data

CR 1s

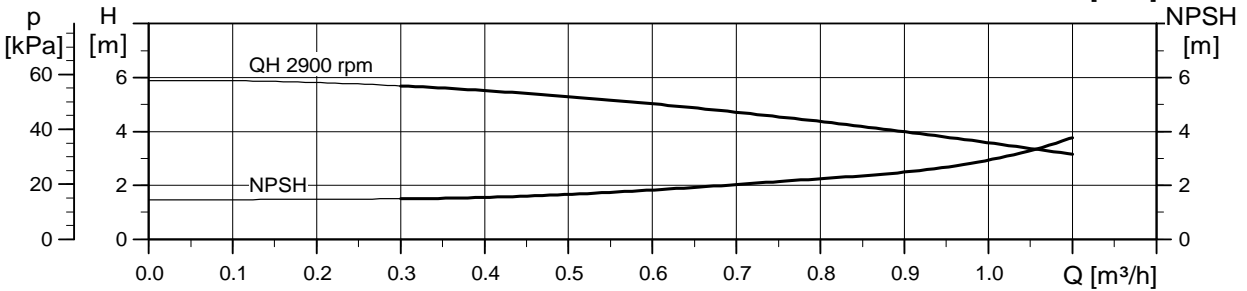
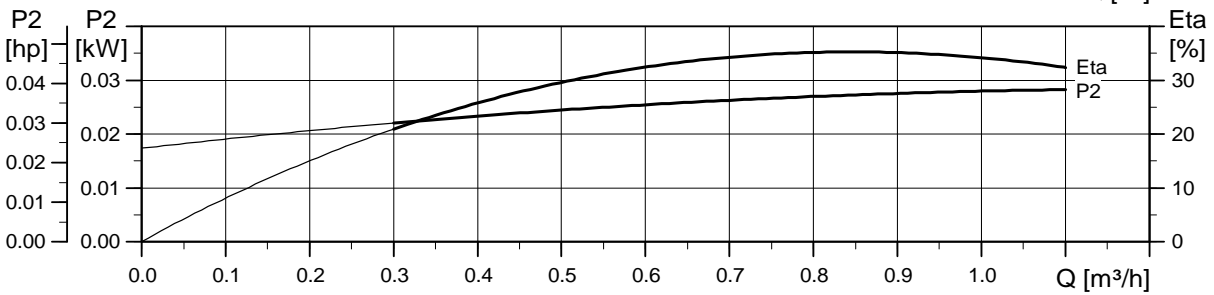
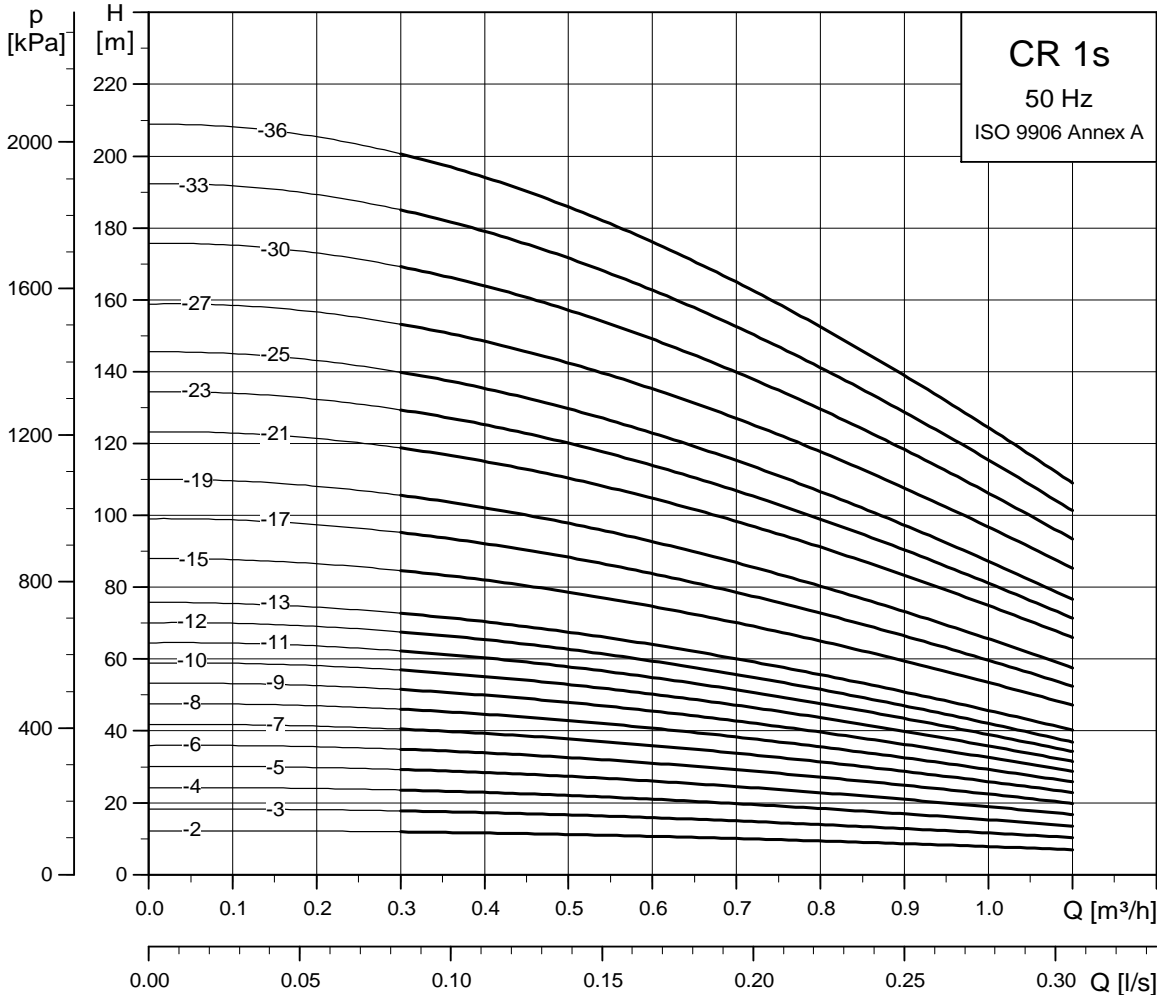

TM02 7424 3605

CRI, CRN 1s

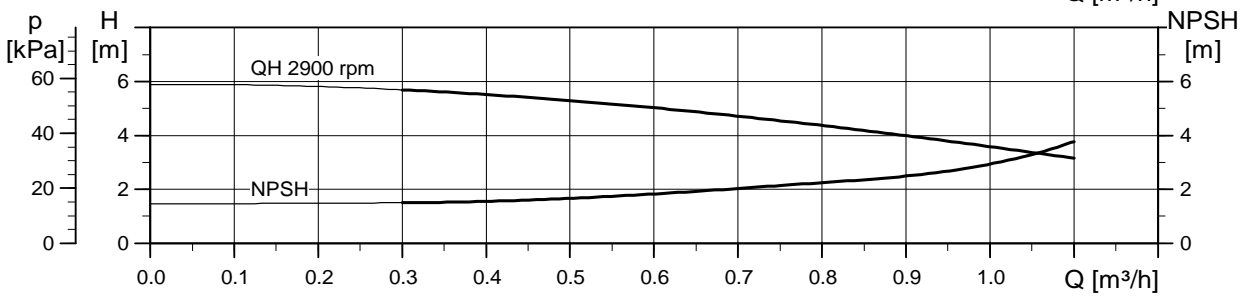
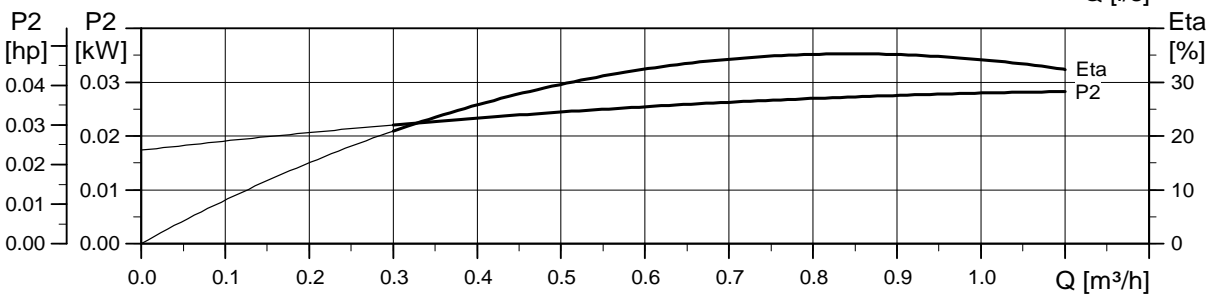
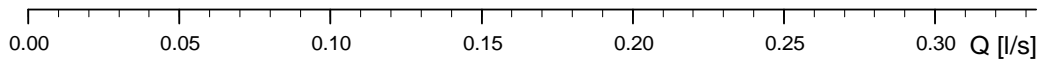
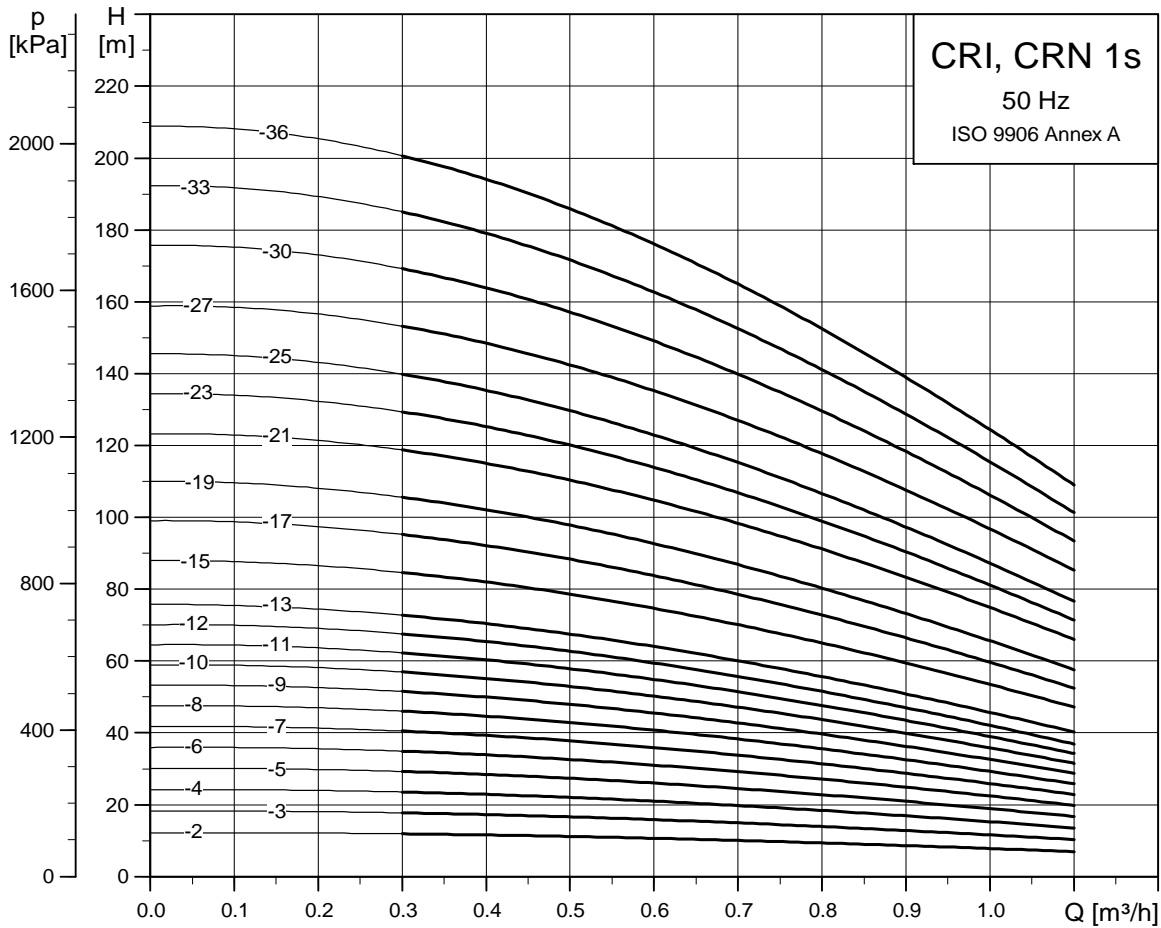

TM02 7425 3605

Dimensional sketch

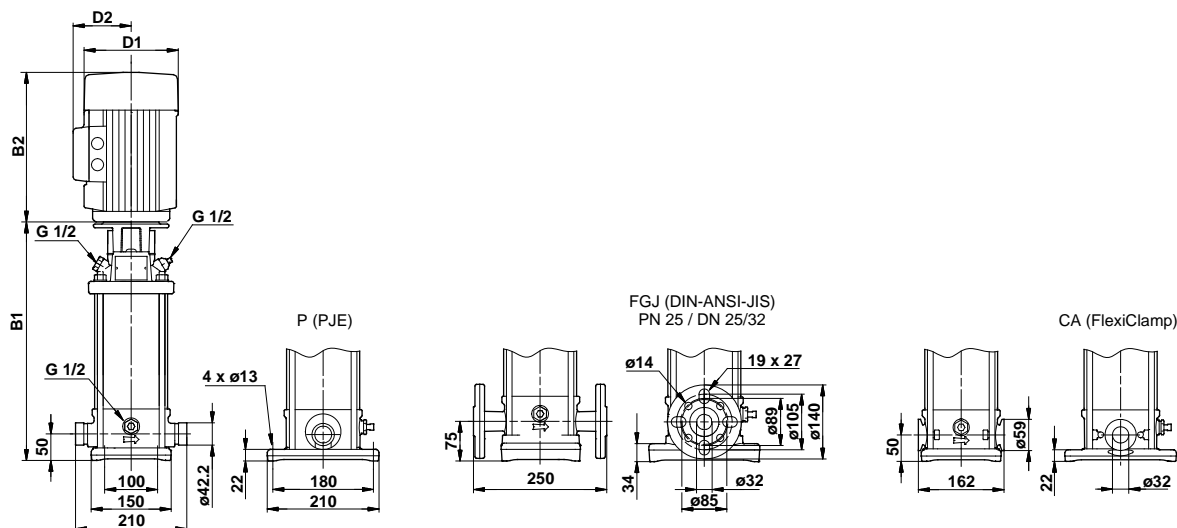

TM03 1722 2805

Dimensions and weights

Pump type	Motor P ₂ [kW]	Dimension [mm]						Net weight [kg]	
		PJE/CA		DIN flange		D1	D2	PJE/CA	DIN flange
		B1	B1+B2	B1	B1+B2				
CRI/CRN 1s-2	0.37	257	448	282	473	141	109	16	20
CRI/CRN 1s-3	0.37	257	448	282	473	141	109	16	21
CRI/CRN 1s-4	0.37	275	466	300	491	141	109	17	21
CRI/CRN 1s-5	0.37	293	484	318	509	141	109	17	21
CRI/CRN 1s-6	0.37	311	502	336	527	141	109	18	22
CRI/CRN 1s-7	0.37	329	520	354	545	141	109	18	22
CRI/CRN 1s-8	0.37	347	538	372	563	141	109	18	23
CRI/CRN 1s-9	0.37	365	556	390	581	141	109	19	23
CRI/CRN 1s-10	0.37	383	574	408	599	141	109	19	23
CRI/CRN 1s-11	0.37	401	592	426	617	141	109	20	24
CRI/CRN 1s-12	0.37	419	610	444	635	141	109	20	24
CRI/CRN 1s-13	0.37	437	628	462	653	141	109	20	25
CRI/CRN 1s-15	0.55	473	664	498	689	141	109	22	26
CRI/CRN 1s-17	0.55	509	700	534	725	141	109	23	27
CRI/CRN 1s-19	0.55	545	736	570	761	141	109	23	28
CRI/CRN 1s-21	0.75	587	818	612	843	141	109	26	31
CRI/CRN 1s-23	0.75	623	854	648	879	141	109	27	31
CRI/CRN 1s-25	0.75	659	890	684	915	141	109	28	32
CRI/CRN 1s-27	1.1	695	946	720	971	141	109	31	35
CRI/CRN 1s-30	1.1	749	1000	774	1025	141	109	32	36
CRI/CRN 1s-33	1.1	803	1054	828	1079	141	109	33	37
CRI/CRN 1s-36	1.1	857	1108	882	1133	141	109	34	39

CR, CRE 1

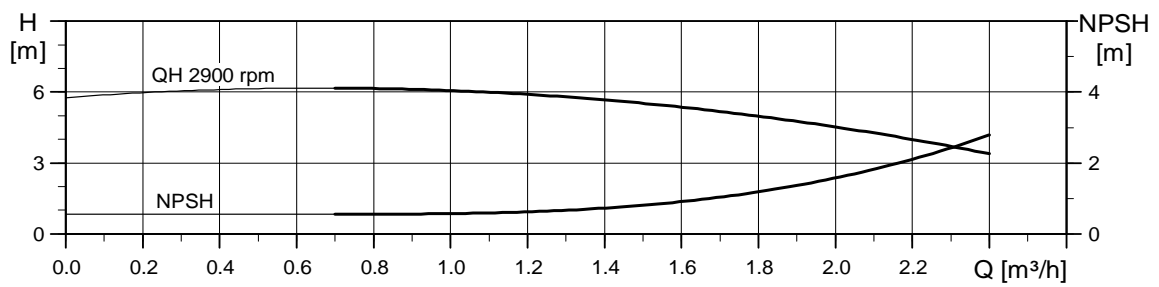
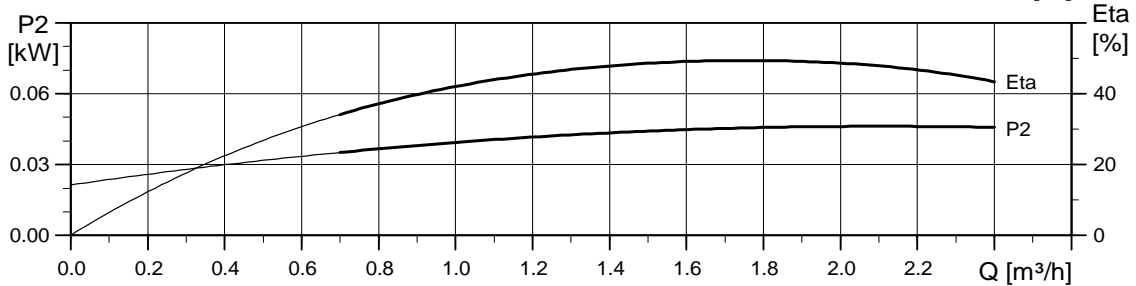
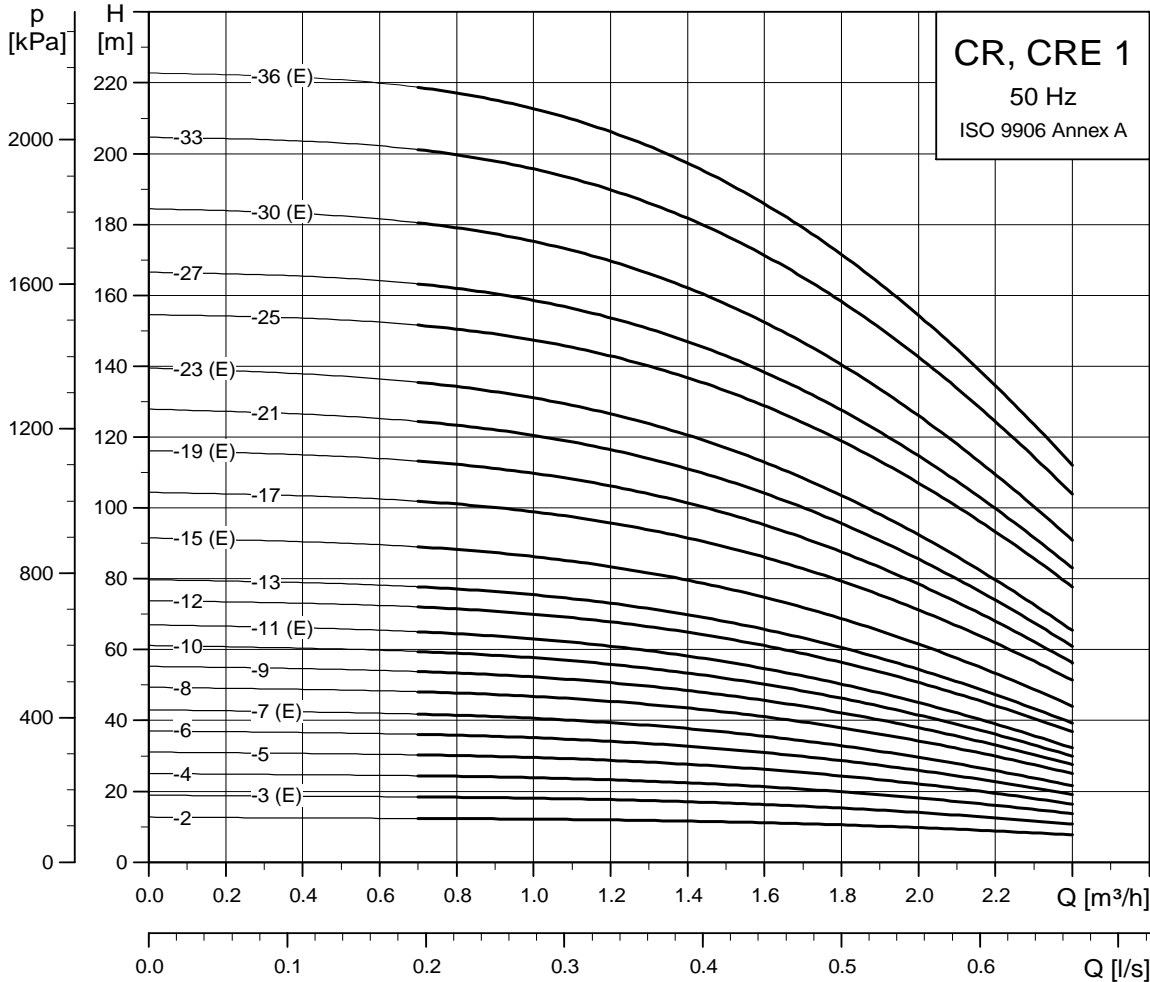

TM02 7290 3605

CRI, CRN, CRIE, CRNE 1

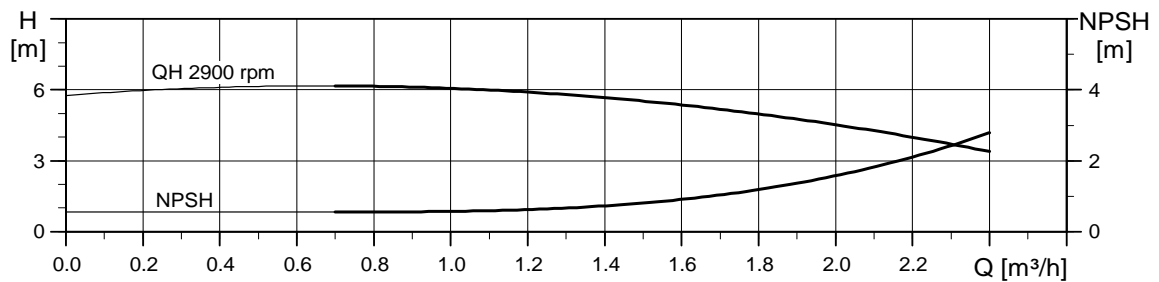
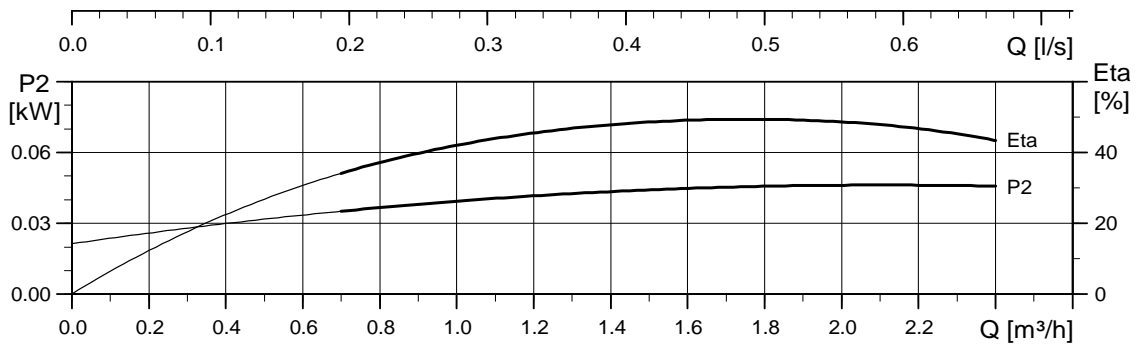
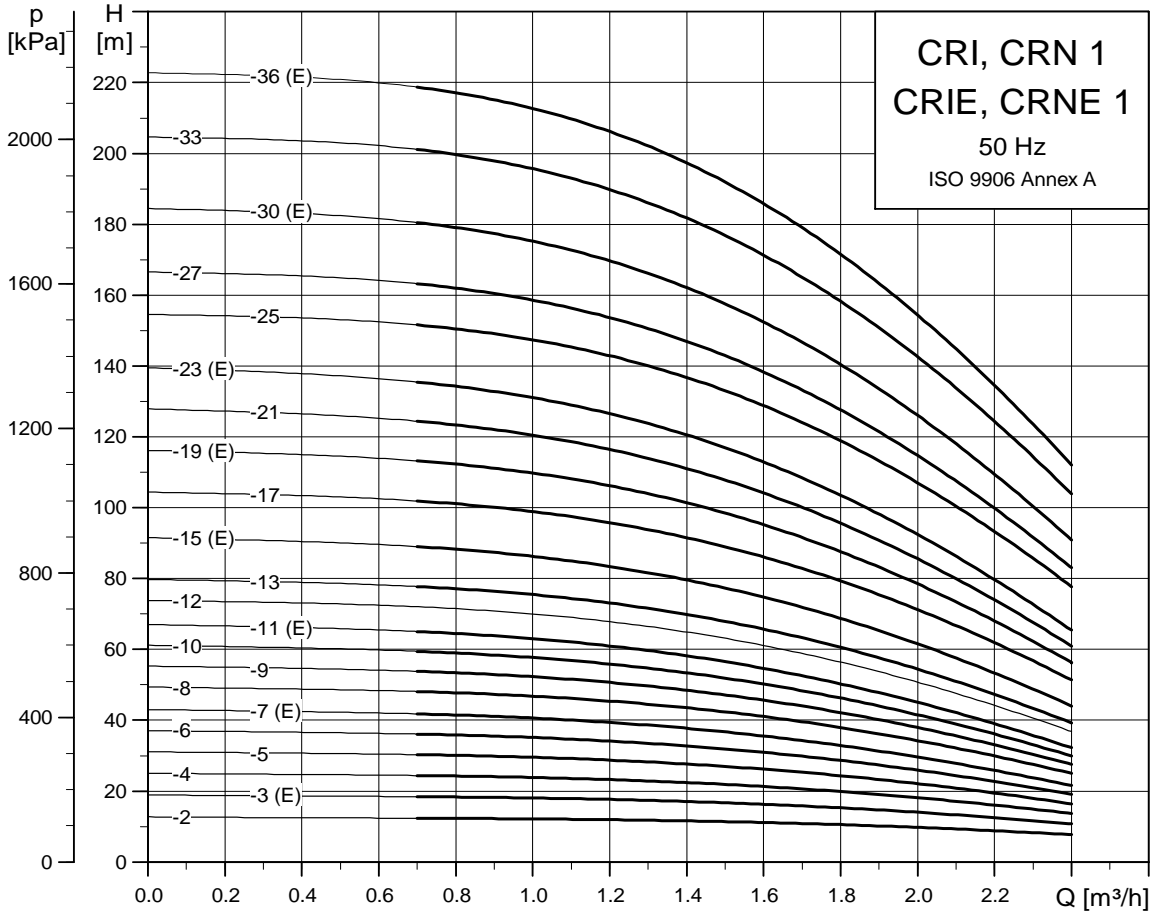

TM02 7291 3605

Dimensional sketch

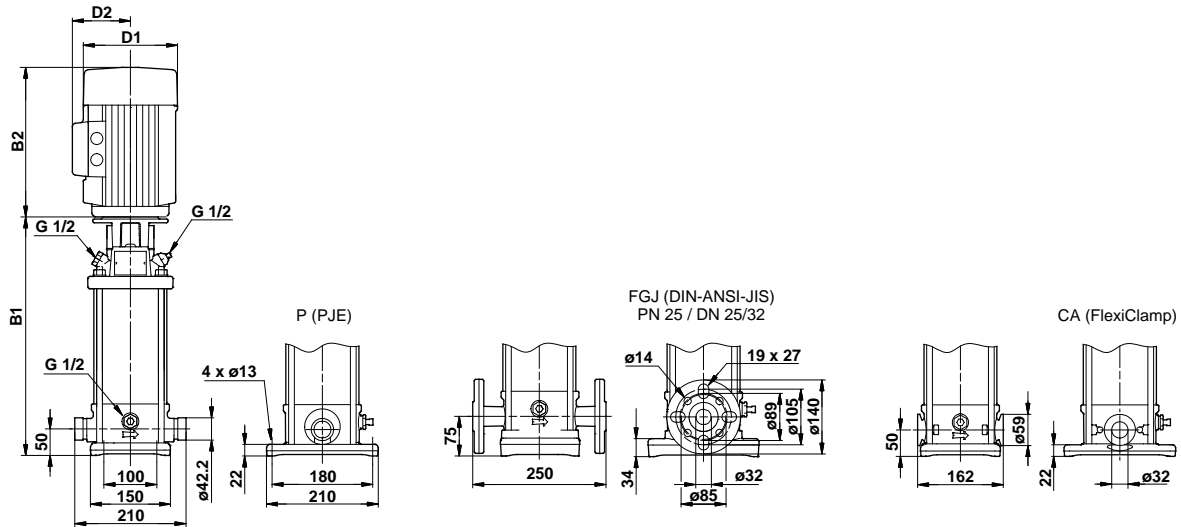

TM03 1722 2805

Dimensions and weights

Pump type	Motor P ₂ [kW]	CRI/CRN								CRIE/CRNE							
		Dimension [mm]						Net weight [kg]		Dimension [mm]						Net weight [kg]	
		PJE/CA		DIN flange		D1	D2	PJE/CA	DIN flange	PJE/CA		DIN flange		D1	D2	PJE/CA	DIN flange
		B1	B1+B2	B1	B1+B2					B1	B1+B2	B1	B1+B2				
CRI/CRN 1-2	0.37	257	448	282	473	141	109	16	20	-	-	-	-	-	-	-	-
CRI(E)/CRN(E) 1-3	0.37	257	448	282	473	141	109	16	21	257	448	282	473	141	140	19	23
CRI/CRN 1-4	0.37	275	466	300	491	141	109	17	21	-	-	-	-	-	-	-	-
CRI/CRN 1-5	0.37	293	484	318	509	141	109	17	21	-	-	-	-	-	-	-	-
CRI/CRN 1-6	0.37	311	502	336	527	141	109	18	22	-	-	-	-	-	-	-	-
CRI(E)/CRN(E) 1-7	0.37	329	520	354	545	141	109	18	22	329	520	354	545	141	140	21	25
CRI/CRN 1-8	0.55	347	538	372	563	141	109	19	23	-	-	-	-	-	-	-	-
CRI/CRN 1-9	0.55	365	556	390	581	141	109	20	24	-	-	-	-	-	-	-	-
CRI/CRN 1-10	0.55	383	574	408	599	141	109	20	24	-	-	-	-	-	-	-	-
CRI(E)/CRN(E) 1-11	0.55	401	592	426	617	141	109	20	24	401	592	426	617	141	140	23	27
CRI/CRN 1-12	0.75	425	656	450	681	141	109	23	27	-	-	-	-	-	-	-	-
CRI/CRN 1-13	0.75	443	674	468	699	141	109	23	28	-	-	-	-	-	-	-	-
CRI(E)/CRN(E) 1-15	0.75	479	710	504	735	141	109	24	28	479	710	504	735	178	167	27	31
CRI/CRN 1-17	1.1	515	766	540	791	141	109	27	31	-	-	-	-	-	-	-	-
CRI(E)/CRN(E) 1-19	1.1	551	802	576	827	141	109	28	32	551	782	576	807	178	167	30	34
CRI/CRN 1-21	1.1	587	838	612	863	141	109	29	33	-	-	-	-	-	-	-	-
CRI(E)/CRN(E) 1-23	1.1	623	874	648	899	141	109	30	34	623	854	648	879	178	167	32	36
CRI/CRN 1-25	1.5	675	956	700	981	178	110	37	41	-	-	-	-	-	-	-	-
CRI/CRN 1-27	1.5	711	992	736	1017	178	110	38	42	-	-	-	-	-	-	-	-
CRI(E)/CRN(E) 1-30	1.5	765	1046	790	1071	178	110	39	43	765	1046	790	1071	178	167	46	50
CRI/CRN 1-33	2.2	819	1140	844	1165	178	110	41	45	-	-	-	-	-	-	-	-
CRI(E)/CRN(E) 1-36	2.2	873	1194	898	1219	178	110	42	46	873	1194	898	1219	178	167	52	56

CR, CRE 3

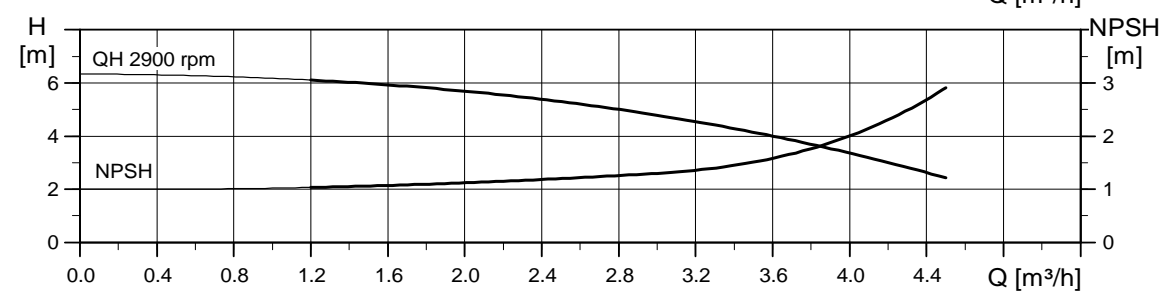
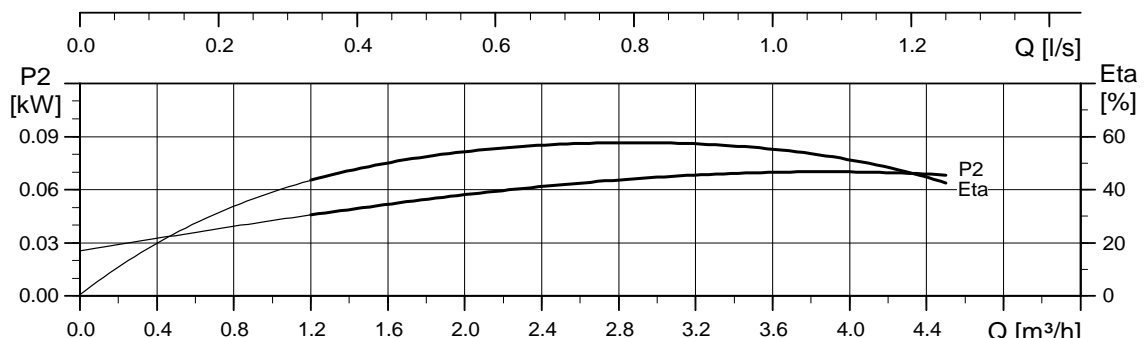
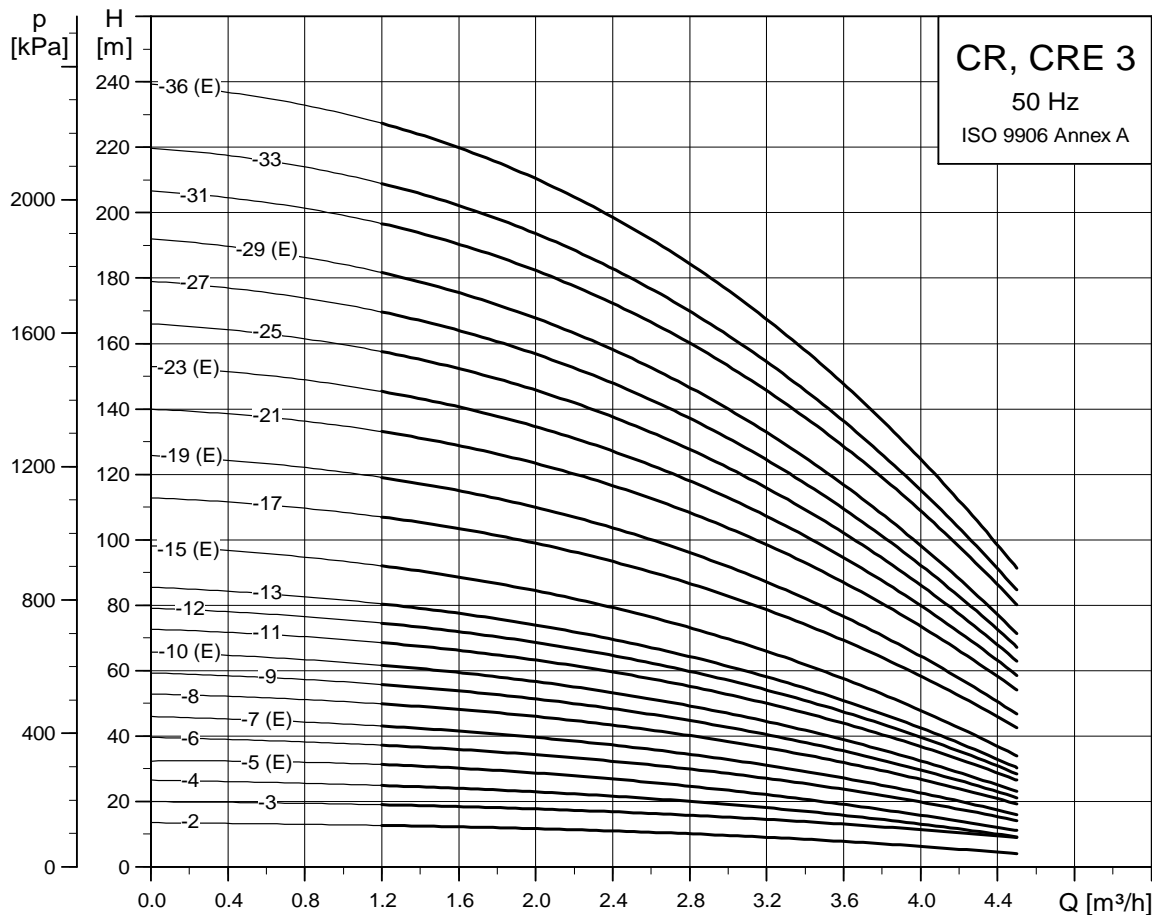

TM02 7292 3605

CRI, CRN, CRIE, CRNE 3

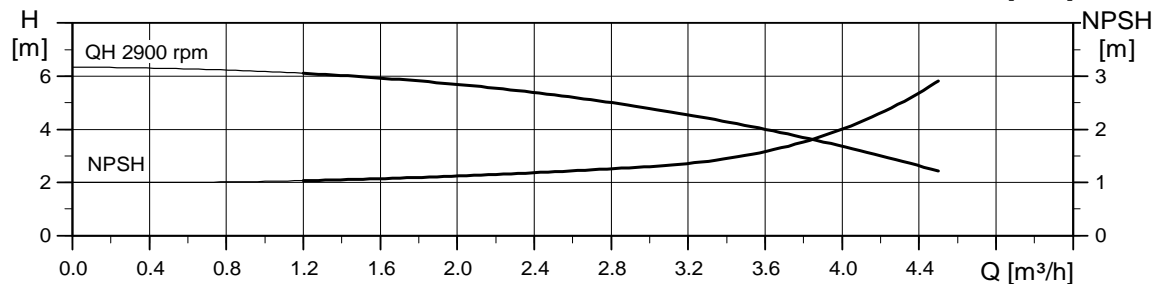
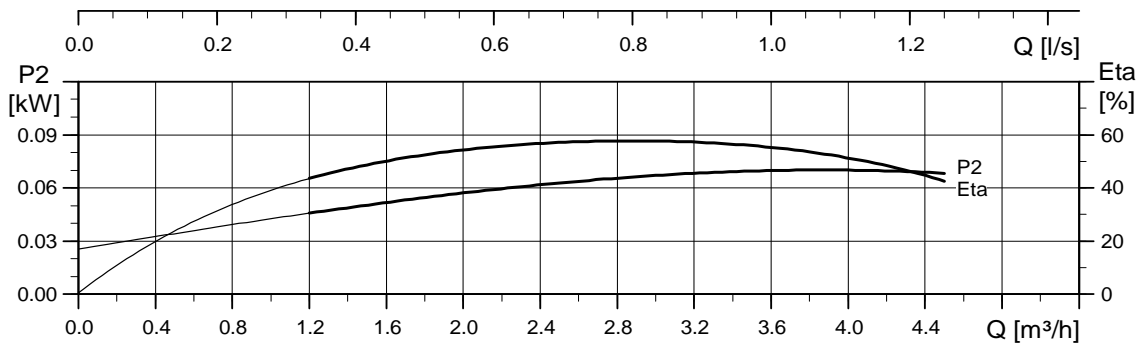
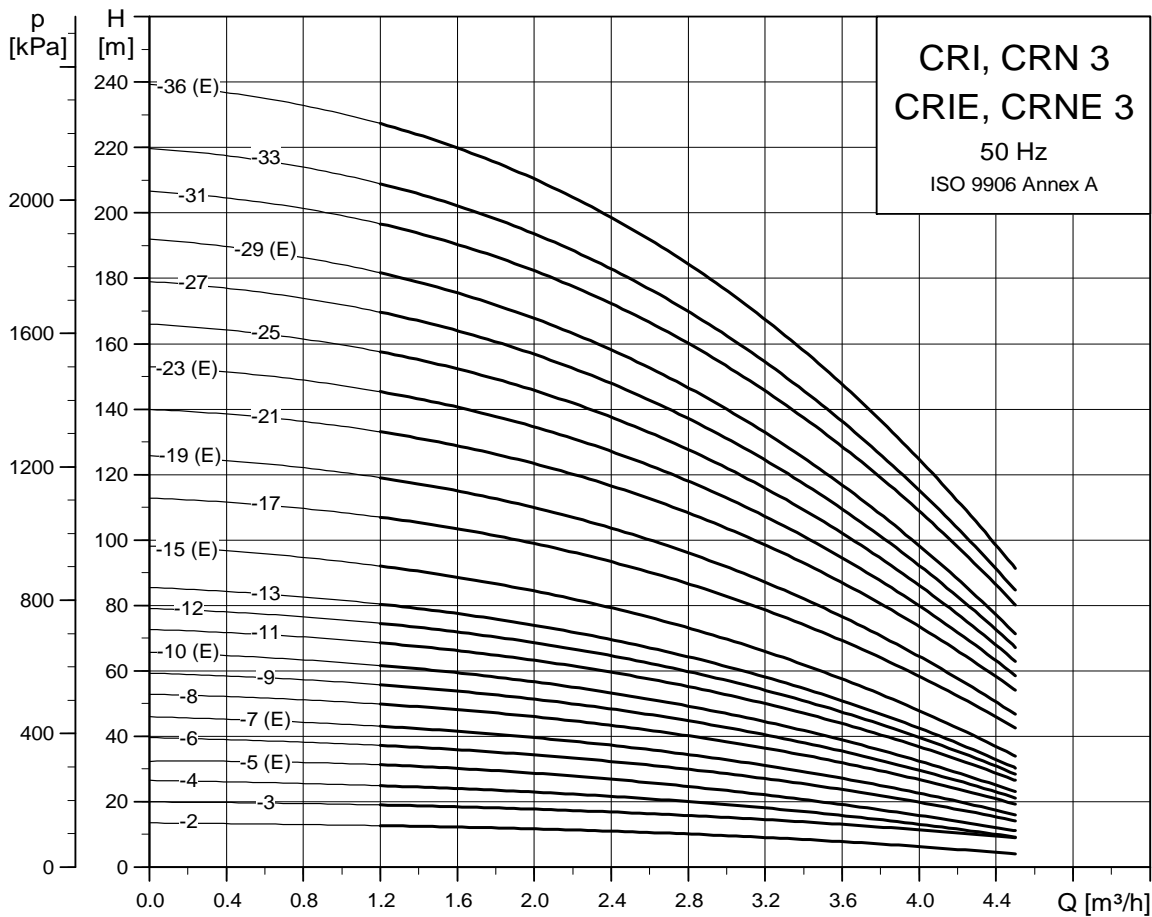

TM02 7293 3605

Dimensional sketch

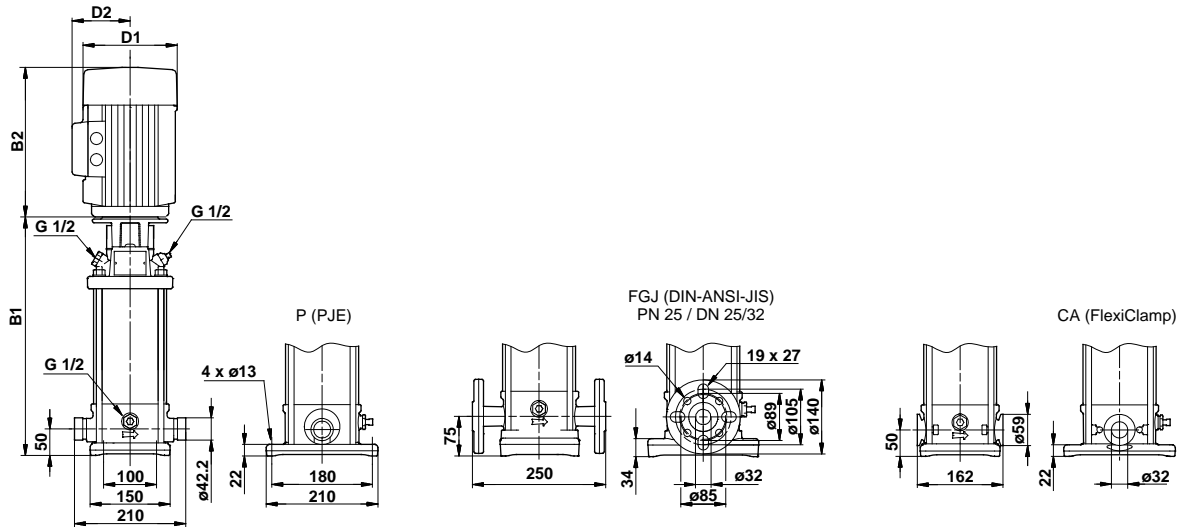

TM03 1722 2805

Dimensions and weights

Pump type	Motor P ₂ [kW]	CRI/CRN								CRIE/CRNE							
		Dimension [mm]				Net weight [kg]				Dimension [mm]				Net weight [kg]			
		PJE/CA		DIN flange		D1	D2	PJE/CA	DIN flange	PJE/CA		DIN flange		D1	D2	PJE/CA	DIN flange
B1	B1+B2	B1	B1+B2			B1	B1+B2	B1	B1+B2	B1	B1+B2			B1	B1+B2		
CRI/CRN 3-2	0.37	257	448	282	473	141	109	16	20	-	-	-	-	-	-	-	
CRI/CRN 3-3	0.37	257	448	282	473	141	109	16	21	-	-	-	-	-	-	-	
CRI/CRN 3-4	0.37	275	466	300	491	141	109	17	21	-	-	-	-	-	-	-	
CRI(E)/CRN(E) 3-5	0.37	293	484	318	509	141	109	17	21	293	484	318	509	141	140	20	24
CRI/CRN 3-6	0.55	311	502	336	527	141	109	18	23	-	-	-	-	-	-	-	
CRI(E)/CRN(E) 3-7	0.55	329	520	354	545	141	109	19	23	329	520	354	545	141	140	21	26
CRI/CRN 3-8	0.75	353	584	378	609	141	109	21	26	-	-	-	-	-	-	-	
CRI/CRN 3-9	0.75	371	602	396	627	141	109	22	26	-	-	-	-	-	-	-	
CRI(E)/CRN(E) 3-10	0.75	389	620	414	645	141	109	22	26	389	620	414	645	178	167	25	29
CRI/CRN 3-11	1.1	407	658	432	683	141	109	25	29	-	-	-	-	-	-	-	
CRI/CRN 3-12	1.1	425	676	450	701	141	109	25	29	-	-	-	-	-	-	-	
CRI/CRN 3-13	1.1	443	694	468	719	141	109	26	30	-	-	-	-	-	-	-	
CRI(E)/CRN(E) 3-15	1.1	479	730	504	755	141	109	26	31	479	710	504	735	178	167	29	33
CRI/CRN 3-17	1.5	531	812	556	837	178	110	34	38	-	-	-	-	-	-	-	
CRI(E)/CRN(E) 3-19	1.5	567	848	592	873	178	110	34	39	567	848	592	873	178	167	41	45
CRI/CRN 3-21	2.2	603	924	628	949	178	110	36	40	-	-	-	-	-	-	-	
CRI(E)/CRN(E) 3-23	2.2	639	960	664	985	178	110	37	41	639	960	664	985	178	167	47	51
CRI/CRN 3-25	2.2	675	996	700	1021	178	110	37	42	-	-	-	-	-	-	-	
CRI/CRN 3-27	2.2	711	1032	736	1057	178	110	38	42	-	-	-	-	-	-	-	
CRI(E)/CRN(E) 3-29	2.2	747	1068	772	1093	178	110	39	43	747	1068	772	1093	178	167	49	54
CRI/CRN 3-31	3	788	1123	813	1148	198	120	46	50	-	-	-	-	-	-	-	
CRI/CRN 3-33	3	824	1159	849	1184	198	120	47	51	-	-	-	-	-	-	-	
CRI(E)/CRN(E) 3-36	3	878	1213	903	1238	198	120	48	52	878	1213	903	1238	198	177	56	60

CR, CRE 5

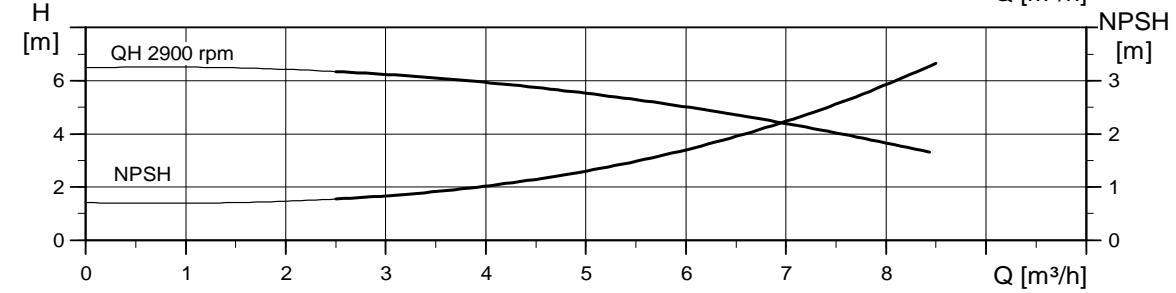
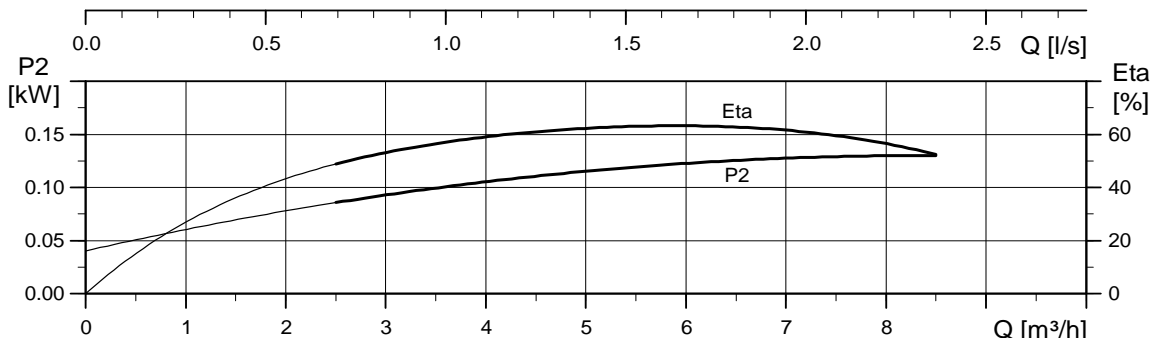
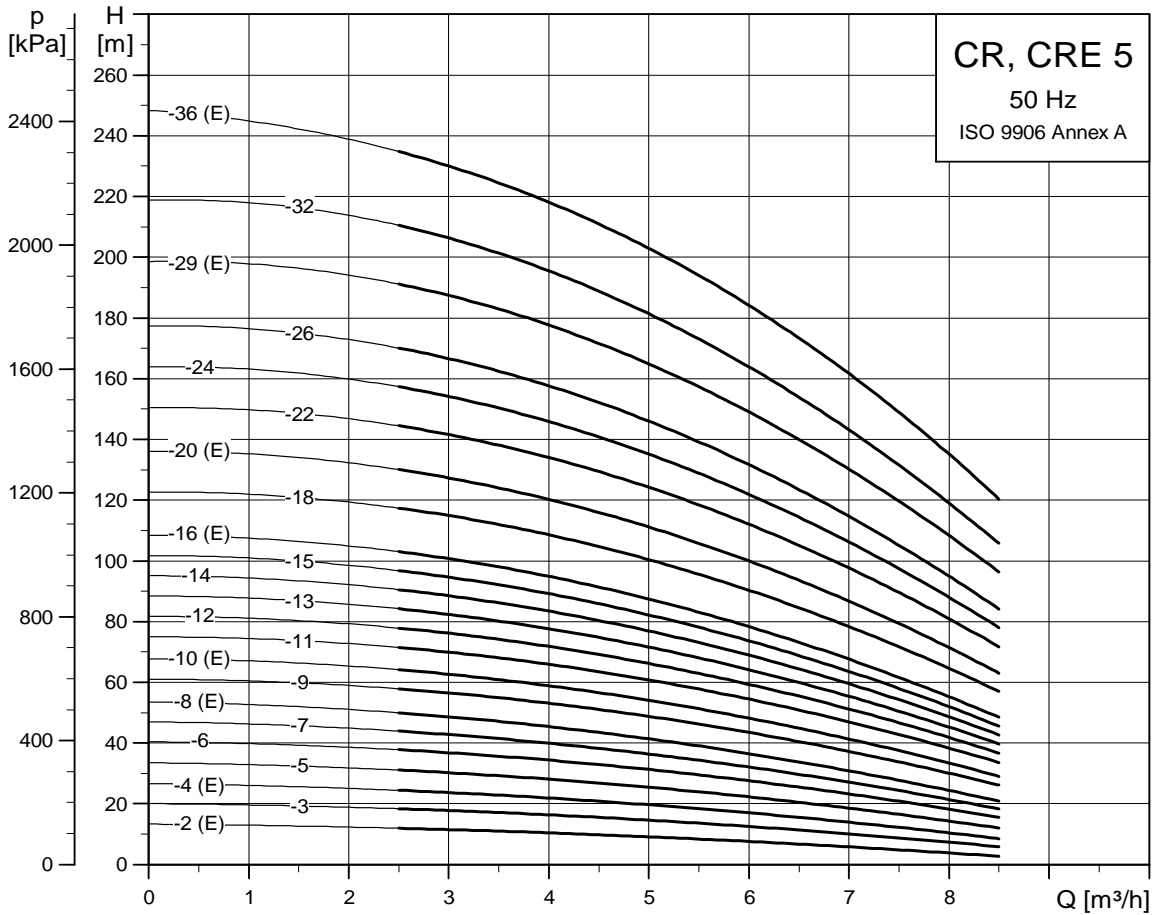

TM02 7294-3605

Dimensional sketch

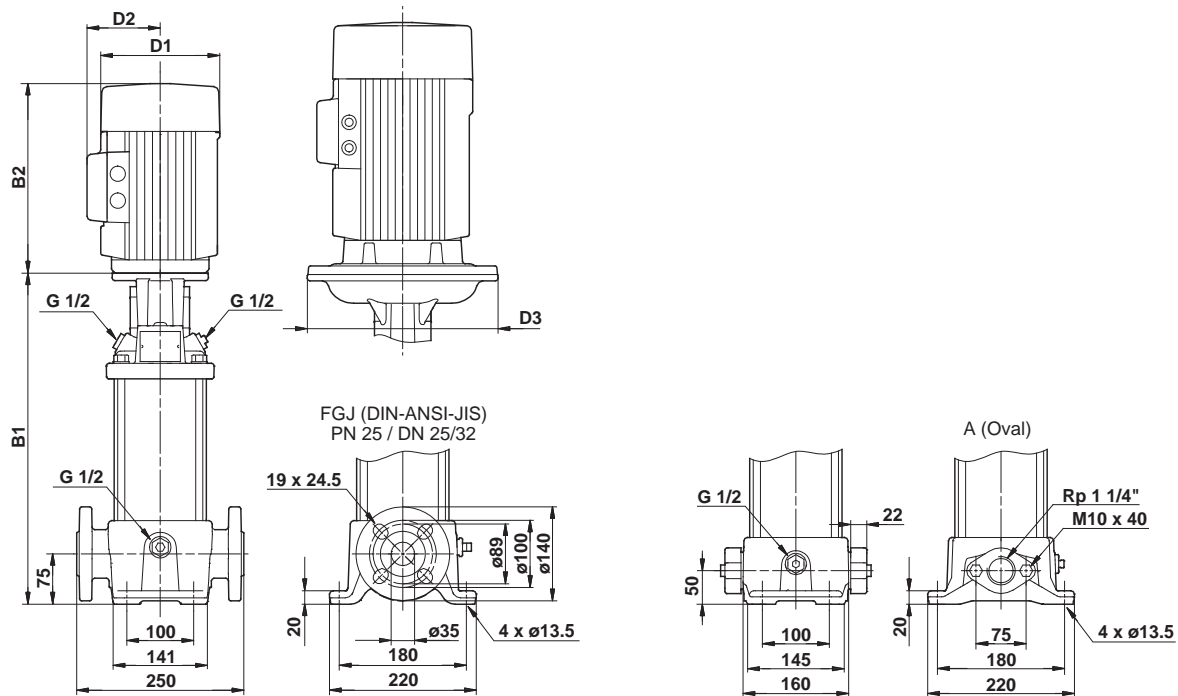

TM03 1723 2805

Dimensions and weights

Pump type	Motor P ₂ [kW]	CR									CRE								
		Dimension [mm]						Net weight [kg]			Dimension [mm]						Net weight [kg]		
		Oval flange		DIN flange		D1	D2	D3	Oval flange	DIN flange		Oval flange		DIN flange		D1	D2	D3	Oval flange
B1	B1+B2	B1	B1+B2				B1	B1+B2		B1	B1+B2	B1	B1+B2				B1	B1+B2	
CR(E) 5-2	0.37	254	445	279	470	141	109	-	18	23	254	445	279	470	141	140	-	21	26
CR 5-3	0.55	281	472	306	497	141	109	-	20	24	-	-	-	-	-	-	-	-	-
CR(E) 5-4	0.55	308	499	333	524	141	109	-	20	25	308	499	333	524	141	140	-	23	27
CR(E) 5-5	0.75	341	572	366	597	141	109	-	22	27	341	572	366	597	178	167	-	25	30
CR 5-6	1.1	368	619	393	644	141	109	-	25	30	-	-	-	-	-	-	-	-	-
CR 5-7	1.1	395	646	420	671	141	109	-	26	30	-	-	-	-	-	-	-	-	-
CR(E) 5-8	1.1	422	673	447	698	141	109	-	26	31	422	653	447	678	178	167	-	28	33
CR 5-9	1.5	465	746	490	771	178	110	-	34	38	-	-	-	-	-	-	-	-	-
CR(E) 5-10	1.5	492	773	517	798	178	110	-	34	39	492	773	517	798	178	167	-	41	46
CR 5-11	2.2	519	840	544	865	178	110	-	36	40	-	-	-	-	-	-	-	-	-
CR 5-12	2.2	546	867	571	892	178	110	-	36	41	-	-	-	-	-	-	-	-	-
CR 5-13	2.2	573	894	598	919	178	110	-	37	41	-	-	-	-	-	-	-	-	-
CR 5-14	2.2	600	921	625	946	178	110	-	37	42	-	-	-	-	-	-	-	-	-
CR 5-15	2.2	627	948	652	973	178	110	-	38	43	-	-	-	-	-	-	-	-	-
CR(E) 5-16	2.2	654	975	679	1000	178	110	-	38	43	654	975	679	1000	178	167	-	49	53
CR 5-18	3	712	1047	737	1072	198	120	-	46	50	-	-	-	-	-	-	-	-	-
CR(E) 5-20	3	766	1101	791	1126	198	120	-	47	52	766	1101	791	1126	198	177	-	55	60
CR 5-22	4	820	1192	845	1217	220	134	-	57	62	-	-	-	-	-	-	-	-	-
CR 5-24	4	-	-	899	1271	220	134	-	-	63	-	-	-	-	-	-	-	-	-
CR 5-26	4	-	-	953	1325	220	134	-	-	64	-	-	-	-	-	-	-	-	-
CR(E) 5-29	4	-	-	1034	1406	220	134	-	-	66	-	-	1034	1406	220	188	-	-	76
CR 5-32	5.5	-	-	1145	1536	220	134	300	-	82	-	-	-	-	-	-	-	-	-
CR(E) 5-36	5.5	-	-	1253	1644	220	134	300	-	84	-	-	1253	1644	220	188	-	-	91

CRI, CRN, CRIE, CRNE 5

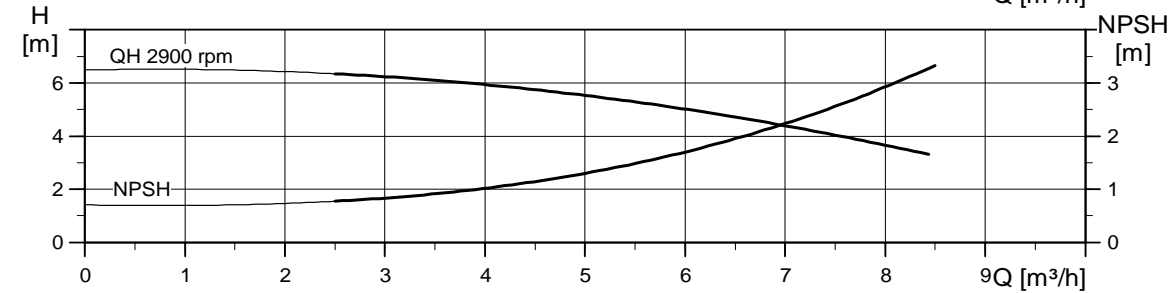
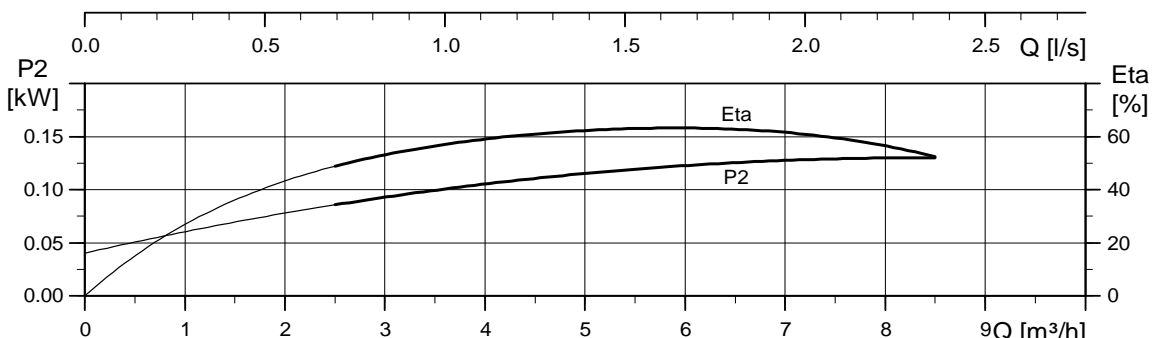
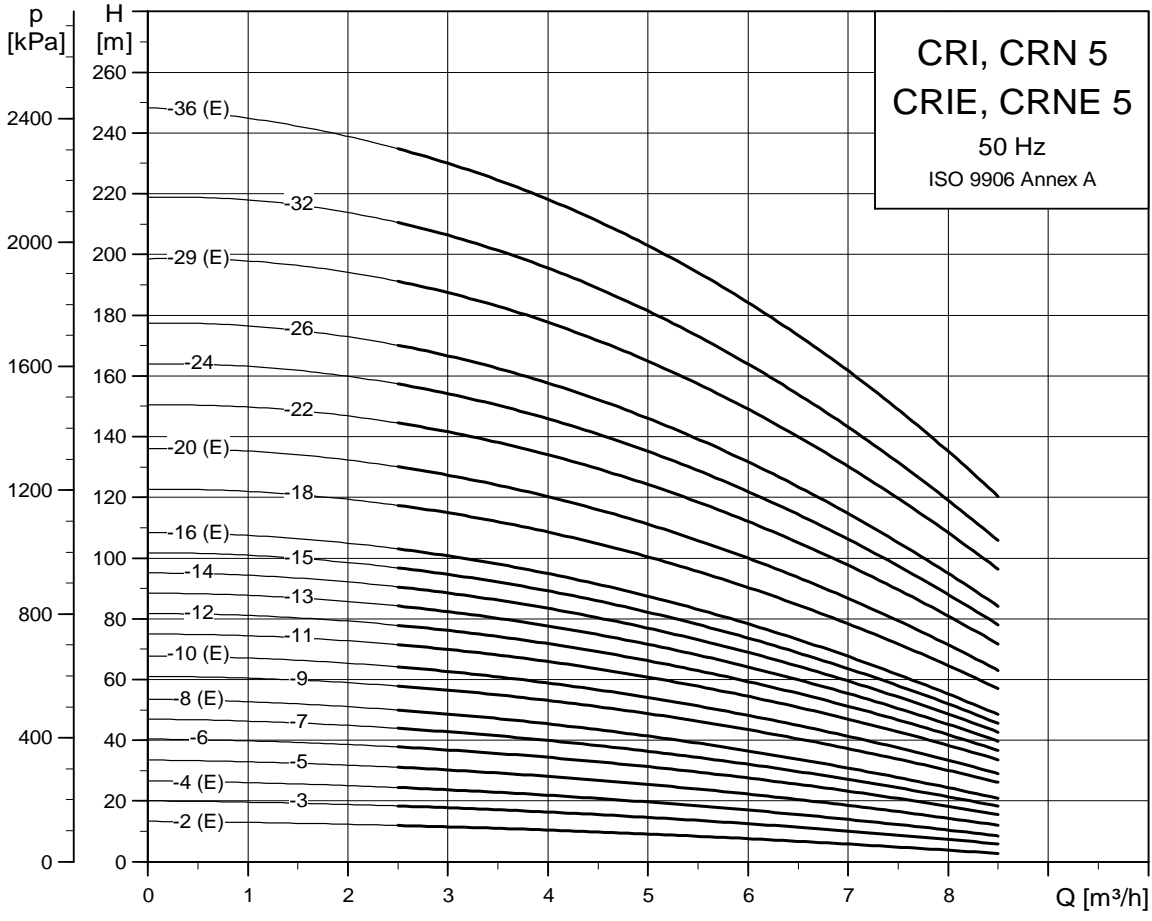

TN02 7295 3605

Dimensional sketch

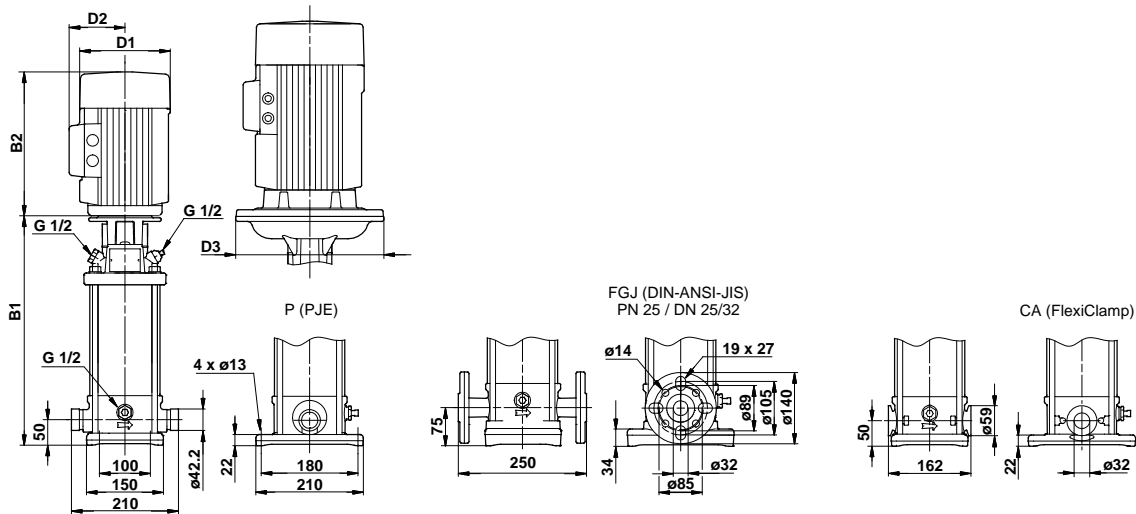

TM03 1724 2805

Dimensions and weights

Pump type	Motor P ₂ [kW]	CRI/CRN									CRIE/CRNE								
		Dimension [mm]						Net weight [kg]			Dimension [mm]						Net weight [kg]		
		PJE/CA		DIN flange		D1	D2	D3	PJE/CA	DIN flange	D3	PJE/CA		DIN flange		D1	D2	D3	PJE/CA
B1	B1+B2	B1	B1+B2	B1	B1+B2							B1	B1+B2						
CRI(E)/CRN(E) 5-2	0.37	257	448	282	473	141	109	-	16	21	257	448	282	473	141	140	-	19	23
CRI/CRN 5-3	0.55	284	475	309	500	141	109	-	18	22	-	-	-	-	-	-	-	-	-
CRI(E)/CRN(E) 5-4	0.55	311	502	336	527	141	109	-	18	22	311	502	336	527	141	140	-	21	25
CRI/CRN(E) 5-5	0.75	344	575	369	600	141	109	-	21	25	344	575	369	600	178	167	-	23	27
CRI/CRN 5-6	1.1	371	622	396	647	141	109	-	24	28	-	-	-	-	-	-	-	-	-
CRI/CRN 5-7	1.1	398	649	423	674	141	109	-	24	28	-	-	-	-	-	-	-	-	-
CRI(E)/CRN(E) 5-8	1.1	425	676	450	701	141	109	-	25	29	425	656	450	681	178	167	-	27	31
CRI/CRN 5-9	1.5	468	749	493	774	178	110	-	32	36	-	-	-	-	-	-	-	-	-
CRI(E)/CRN(E) 5-10	1.5	495	776	520	801	178	110	-	32	37	495	776	520	801	178	167	-	39	43
CRI/CRN 5-11	2.2	522	843	547	868	178	110	-	34	38	-	-	-	-	-	-	-	-	-
CRI/CRN 5-12	2.2	549	870	574	895	178	110	-	34	38	-	-	-	-	-	-	-	-	-
CRI/CRN 5-13	2.2	576	897	601	922	178	110	-	35	39	-	-	-	-	-	-	-	-	-
CRI/CRN 5-14	2.2	603	924	628	949	178	110	-	35	40	-	-	-	-	-	-	-	-	-
CRI/CRN 5-15	2.2	630	951	655	976	178	110	-	36	40	-	-	-	-	-	-	-	-	-
CRI(E)/CRN(E) 5-16	2.2	657	978	682	1003	178	110	-	36	41	657	978	682	1003	178	167	-	47	51
CRI/CRN 5-18	3	716	1051	741	1076	198	120	-	44	48	-	-	-	-	-	-	-	-	-
CRI(E)/CRN(E) 5-20	3	770	1105	795	1130	198	120	-	45	49	770	1105	795	1130	198	177	-	53	57
CRI/CRN 5-22	4	824	1196	849	1221	220	134	-	55	59	-	-	-	-	-	-	-	-	-
CRI/CRN 5-24	4	878	1250	903	1275	220	134	-	56	61	-	-	-	-	-	-	-	-	-
CRI/CRN 5-26	4	932	1304	957	1329	220	134	-	58	62	-	-	-	-	-	-	-	-	-
CRI(E)/CRN(E) 5-29	4	1013	1385	1038	1410	220	134	-	59	64	1013	1385	1038	1410	220	188	-	70	74
CRI/CRN 5-32	5.5	1123	1514	1148	1539	220	134	300	75	79	-	-	-	-	-	-	-	-	-
CRI(E)/CRN(E) 5-36	5.5	1231	1622	1256	1647	220	134	300	77	81	1231	1622	1256	1647	220	188	-	84	88

CR, CRE 10

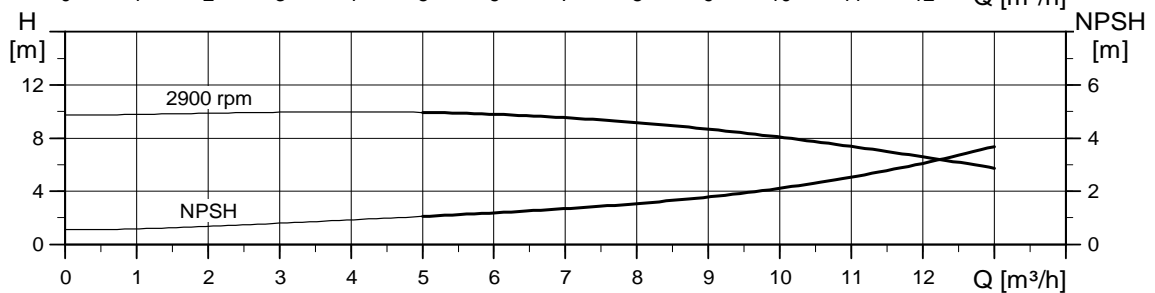
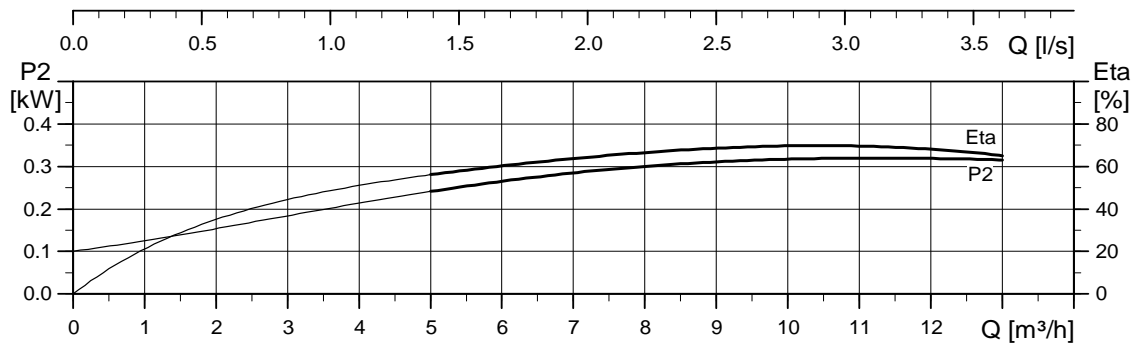
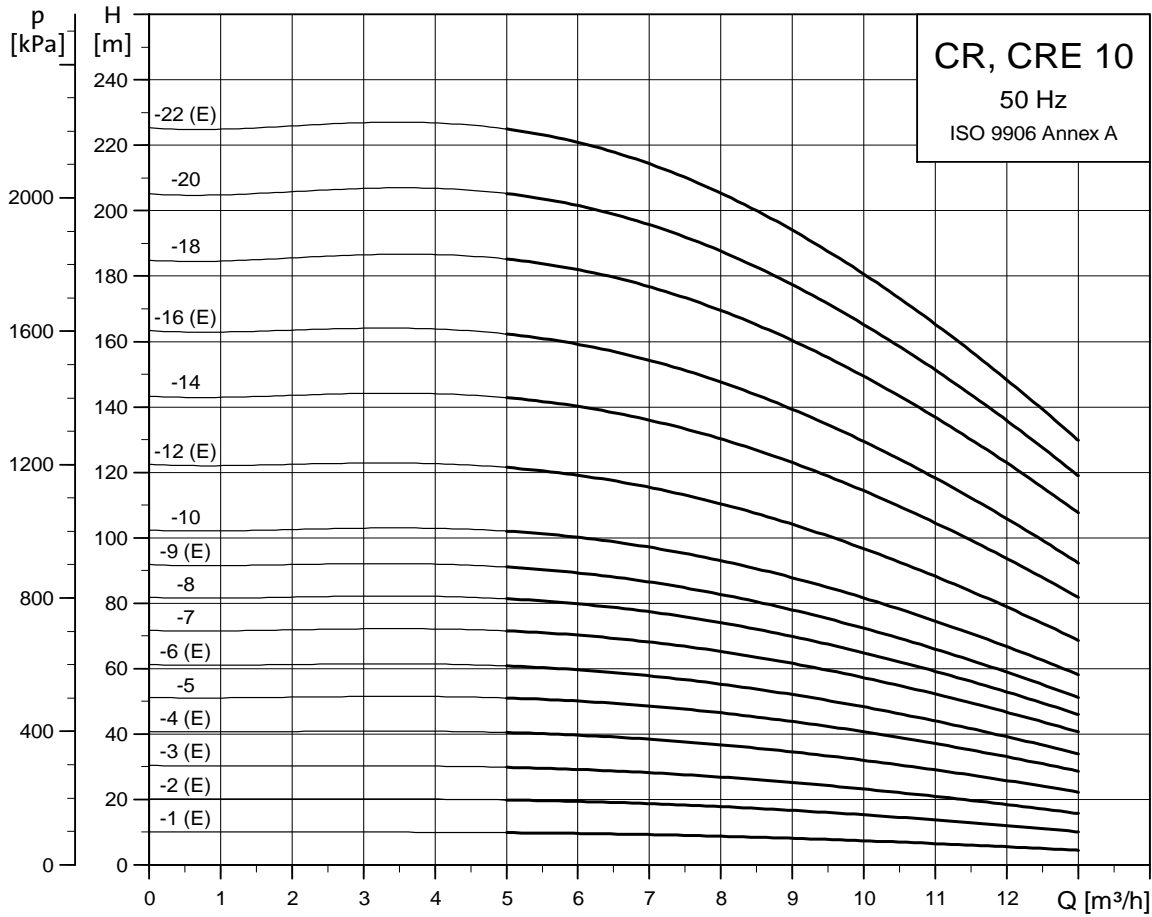

TM02 7296 3605

CRI, CRN, CRIE, CRNE 10

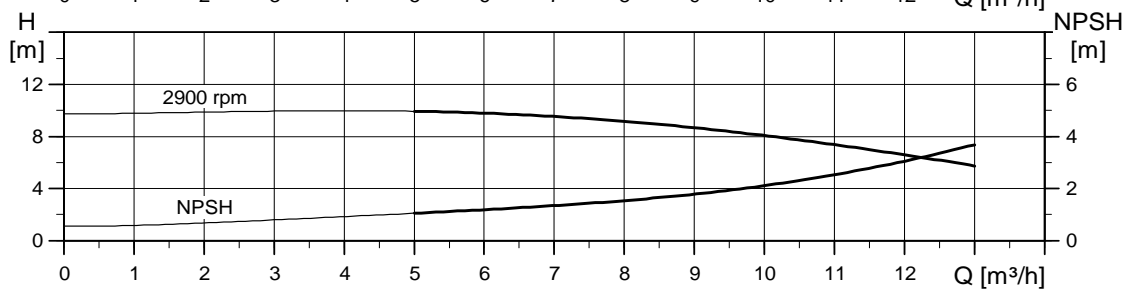
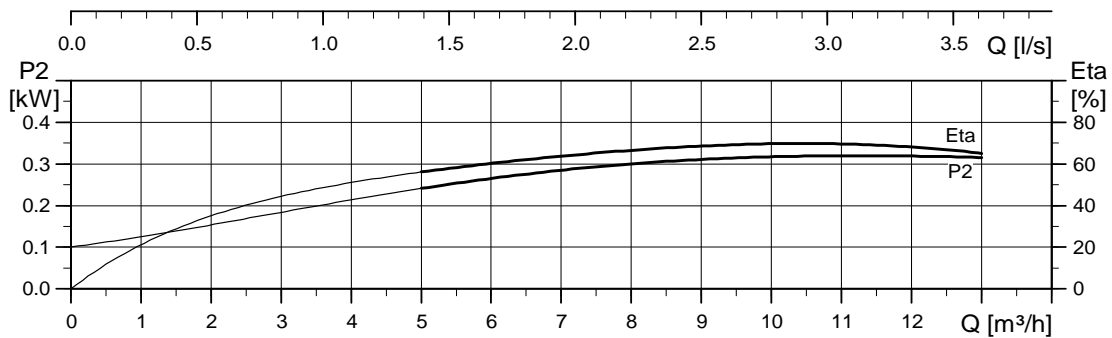
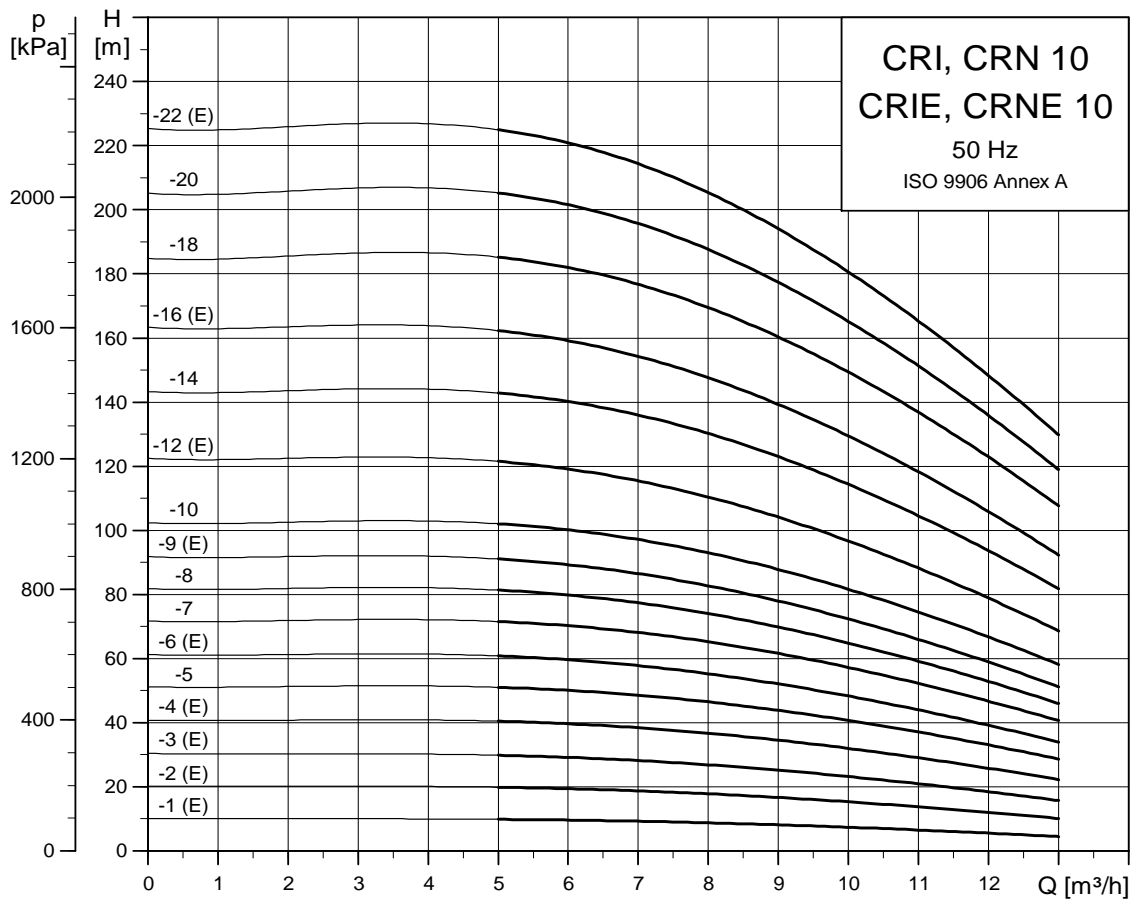

TM02 7297 3605

Dimensional sketch

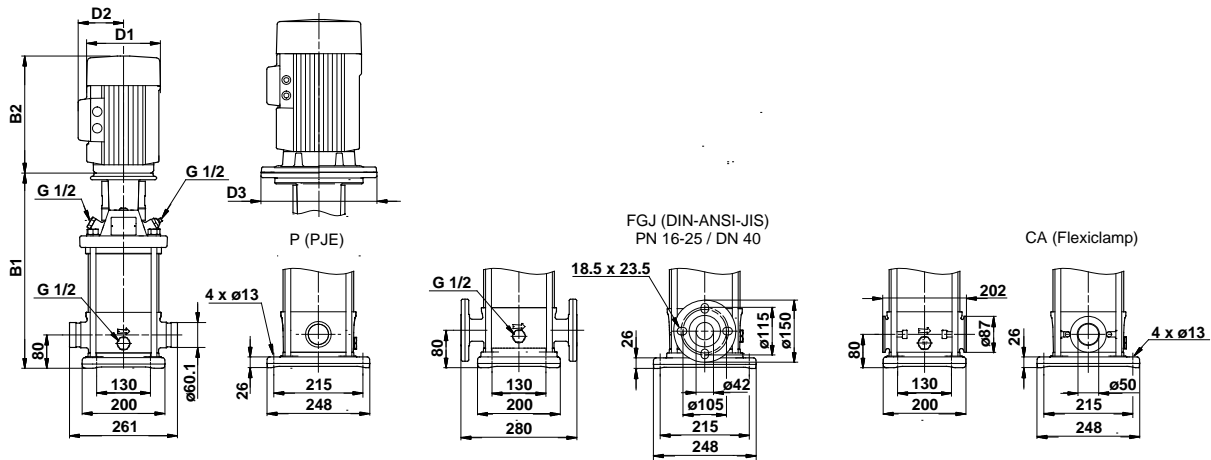

TM03 2498 4405

Dimensions and weights

Pump type	Motor P ₂ [kW]	CRI/CRN									CRIE/CRNE								
		Dimension [mm]						Net weight [kg]			Dimension [mm]						Net weight [kg]		
		PJE/CA		DIN flange		D1	D2	D3	PJE/CA	DIN flange		PJE/CA		DIN flange		D1	D2	D3	PJE/CA
B1	B1+B2	B1	B1+B2				B1	B1+B2		B1	B1+B2	B1	B1+B2				B1	B1+B2	
CRI(E)/CRN(E) 10-1	0.37	353	544	353	544	141	109	-	28	32	353	544	353	544	141	140	-	31	35
CRI(E)/CRN(E) 10-2	0.75	357	588	357	588	141	109	-	31	34	357	588	357	588	178	167	-	33	37
CRI(E)/CRN(E) 10-3	1.1	387	638	387	638	141	109	-	34	38	387	618	387	618	178	167	-	37	40
CRI(E)/CRN(E) 10-4	1.5	433	714	433	714	178	110	-	42	46	433	714	433	714	178	167	-	49	53
CRI/CRN 10-5	2.2	463	784	463	784	178	110	-	44	48	-	-	-	-	-	-	-	-	-
CRI(E)/CRN(E) 10-6	2.2	493	814	493	814	178	110	-	45	49	493	814	493	814	178	167	-	55	59
CRI/CRN 10-7	3	528	863	528	863	198	120	-	52	56	-	-	-	-	-	-	-	-	-
CRI/CRN 10-8	3	558	893	558	893	198	120	-	54	57	-	-	-	-	-	-	-	-	-
CRI(E)/CRN(E) 10-9	3	588	923	588	923	198	120	-	55	58	588	923	588	923	198	177	-	63	66
CRI/CRN 10-10	4	618	990	618	990	220	134	-	65	68	-	-	-	-	-	-	-	-	-
CRI(E)/CRN(E) 10-12	4	678	1050	678	1050	220	134	-	67	70	678	1050	678	1050	220	188	-	77	81
CRI/CRN 10-14	5.5	770	1161	770	1161	220	134	300	89	93	-	-	-	-	-	-	-	-	-
CRI(E)/CRN(E) 10-16	5.5	830	1221	830	1221	220	134	300	91	95	830	1221	830	1221	220	188	300	98	102
CRI/CRN 10-18	7.5	890	1269	890	1269	260	159	300	104	108	-	-	-	-	-	-	-	-	-
CRI/CRN 10-20	7.5	950	1329	950	1329	260	159	300	106	110	-	-	-	-	-	-	-	-	-
CRI(E)/CRN(E) 10-22	7.5	1010	1389	1010	1389	260	159	300	108	112	1010	1401	1010	1401	260	213	300	108	111

CR, CRE 15

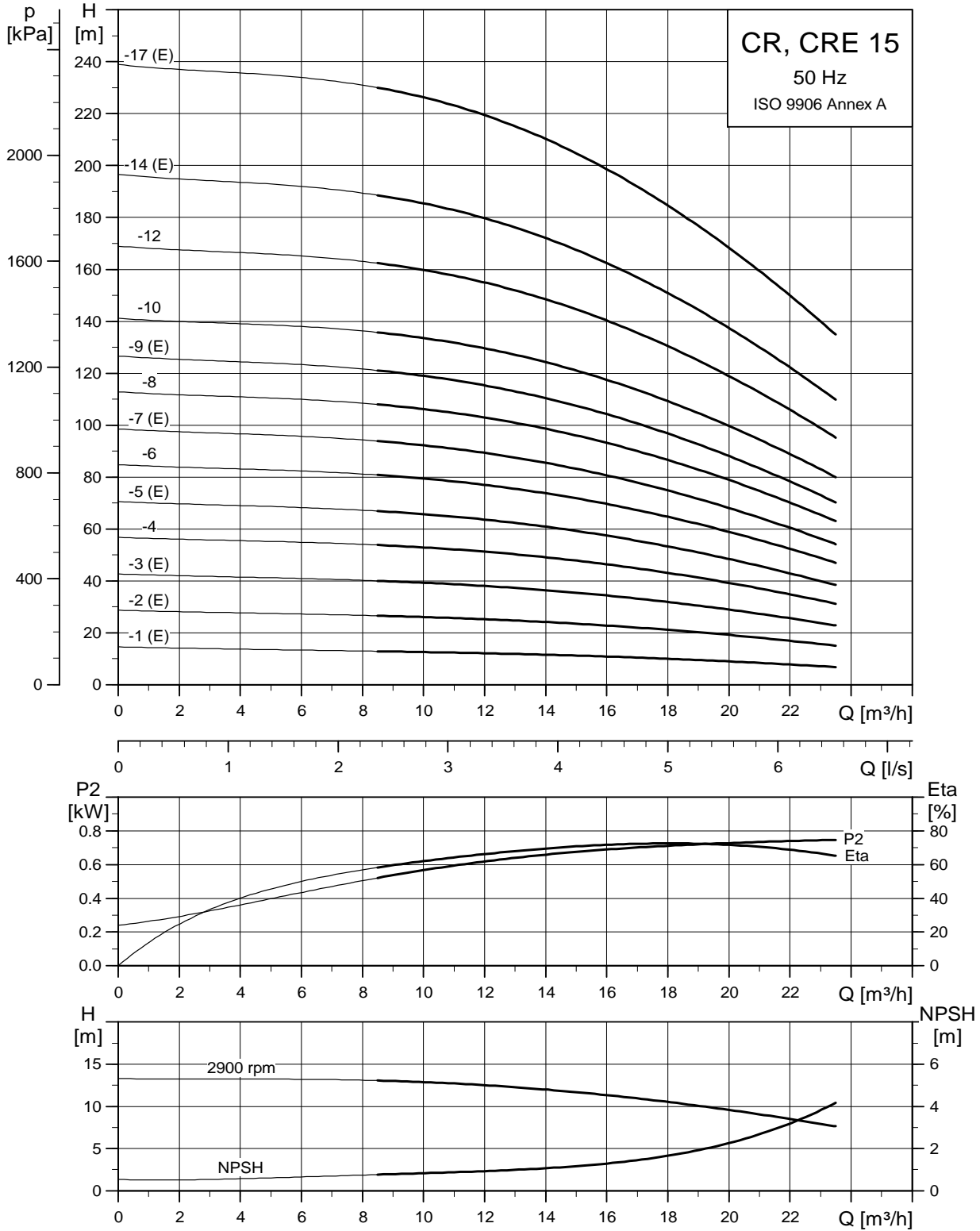

TM02 7298 3605

Dimensional sketch

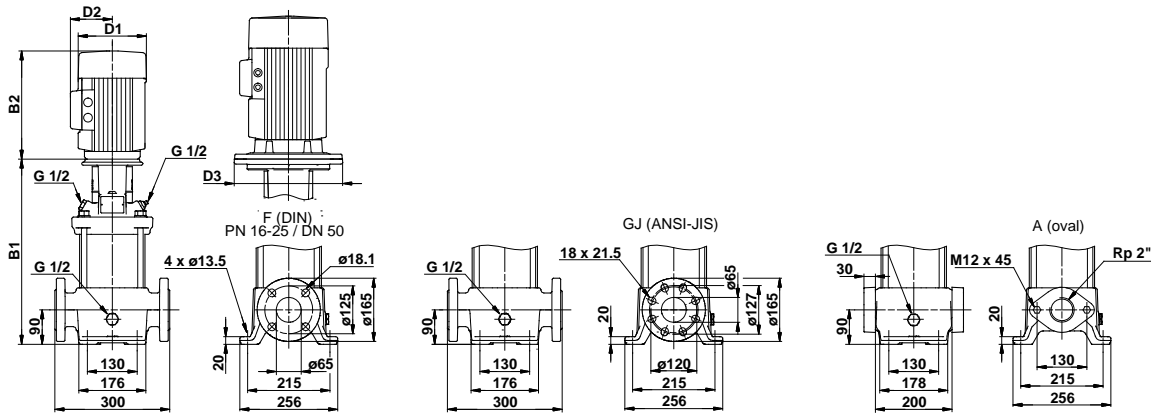

TMO3 1727 2805

Dimensions and weights

Pump type	Motor P ₂ [kW]	CR										CRE							
		Dimension [mm]					Net weight [kg]					Dimension [mm]					Net weight [kg]		
		Oval flange		DIN flange			D1	D2	D3	Oval flange	DIN flange	Oval flange		DIN flange		D1	D2	D3	Oval flange
B1	B1+B2	B1	B1+B2	B1	B1+B2	B1						B1+B2	B1	B1+B2	B1				
CR(E) 15-1	1.1	400	651	400	651	141	109	-	41	42	400	631	400	631	178	167	-	44	45
CR(E) 15-2	2.2	415	736	415	736	178	110	-	49	50	415	736	415	736	178	167	-	59	60
CR(E) 15-3	3	465	800	465	800	198	120	-	56	57	465	800	465	800	198	177	-	64	65
CR 15-4	4	510	882	510	882	220	134	-	67	68	-	-	-	-	-	-	-	-	-
CR(E) 15-5	4	555	927	555	927	220	134	-	68	69	555	927	555	927	220	188	-	78	79
CR 15-6	5.5	632	1023	632	1023	220	134	300	90	91	-	-	-	-	-	-	-	-	-
CR(E) 15-7	5.5	677	1068	677	1068	220	134	300	92	93	677	1068	677	1068	220	188	300	99	100
CR 15-8	7.5	-	-	722	1101	260	159	300	-	107	-	-	-	-	-	-	-	-	-
CR(E) 15-9	7.5	-	-	767	1146	260	159	300	-	108	-	-	767	1158	260	213	300	-	106
CR 15-10	11	-	-	889	1360	314	204	350	-	150	-	-	-	-	-	-	-	-	-
CR 15-12	11	-	-	979	1450	314	204	350	-	154	-	-	-	-	-	-	-	-	-
CR(E) 15-14	11	-	-	1069	1540	314	204	350	-	158	-	-	1084	1555	314	308	350	-	202
CR(E) 15-17	15	-	-	1204	1675	314	204	350	-	175	-	-	1219	1690	314	308	350	-	222

CRI, CRN, CRIE, CRNE 15

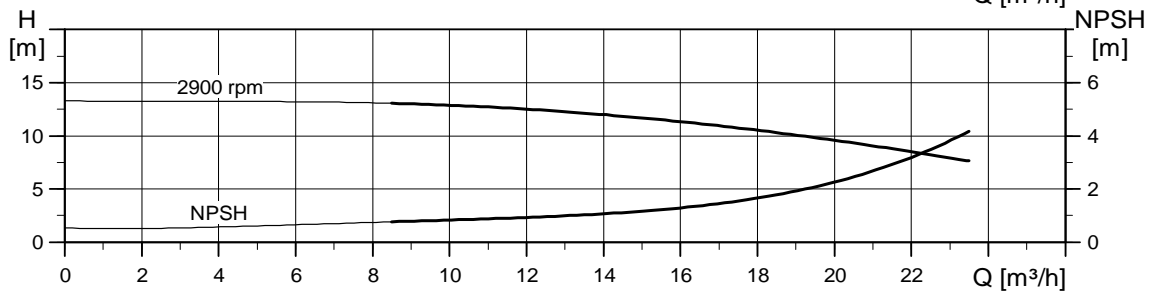
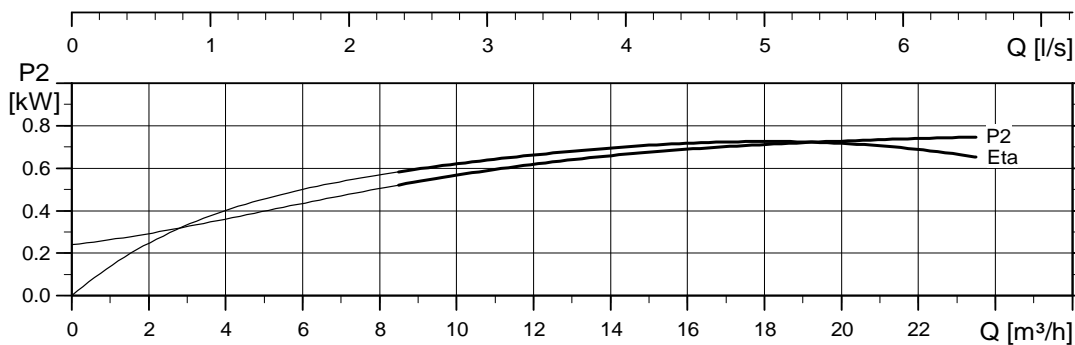
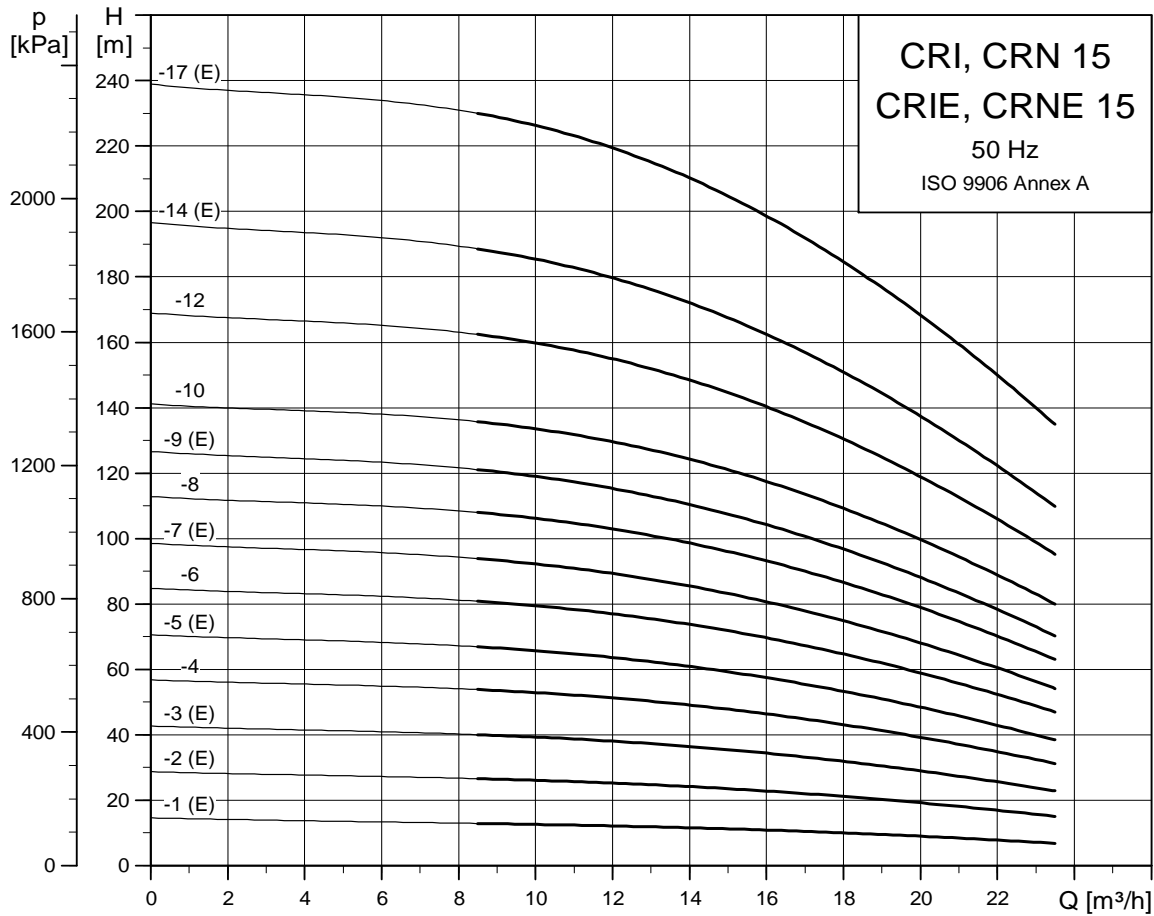

TM02 7299 3605

Dimensional sketch

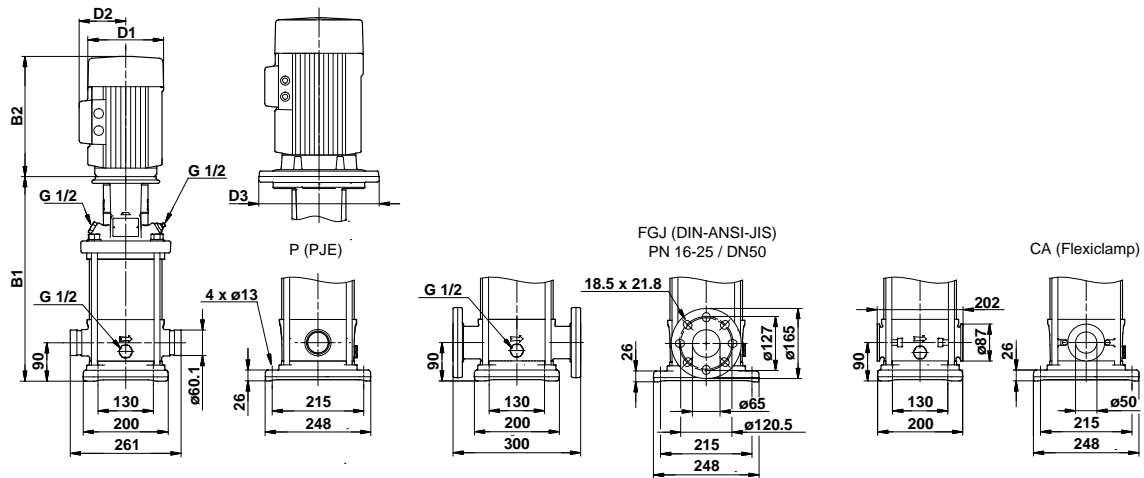

TM03 1728 2805

Dimensions and weights

Pump type	Motor P ₂ [kW]	CRI/CRN									CRIE/CRNE									
		Dimension [mm]									Net weight [kg]		Dimension [mm]						Net weight [kg]	
		PJE/CA		DIN flange		D1	D2	D3	PJE/CA	DIN flange	PJE/CA		DIN flange		D1	D2	D3	PJE/CA	DIN flange	
		B1	B1+B2	B1	B1+B2						B1	B1+B2	B1	B1+B2						
CRI(E)/CRN(E) 15-1	1.1	397	648	397	648	141	109	-	34	39	397	628	397	628	178	167	-	37	42	
CRI(E)/CRN(E) 15-2	2.2	413	734	413	734	178	110	-	42	47	413	734	413	734	178	167	-	53	57	
CRI(E)/CRN(E) 15-3	3	463	798	463	798	198	120	-	50	55	463	798	463	798	198	177	-	58	63	
CRI/CRN 15-4	4	508	880	508	880	220	134	-	61	65	-	-	-	-	-	-	-	-	-	
CRI(E)/CRN(E) 15-5	4	553	925	553	925	220	134	-	62	67	553	925	553	925	220	188	-	72	77	
CRI/CRN 15-6	5.5	630	1021	630	1021	220	134	300	84	89	-	-	-	-	-	-	-	-	-	
CRI(E)/CRN(E) 15-7	5.5	675	1066	675	1066	220	134	300	86	90	675	1066	675	1066	220	188	300	92	97	
CRI/CRN 15-8	7.5	720	1099	720	1099	260	159	300	99	104	-	-	-	-	-	-	-	-	-	
CRI(E)/CRN(E) 15-9	7.5	765	1144	765	1144	260	159	300	101	106	765	1156	765	1156	260	213	300	99	104	
CRI/CRN 15-10	11	887	1358	887	1358	314	204	350	143	148	-	-	-	-	-	-	-	-	-	
CRI/CRN 15-12	11	977	1448	977	1448	314	204	350	146	151	-	-	-	-	-	-	-	-	-	
CRI(E)/CRN(E) 15-14	11	1067	1538	1067	1538	314	204	350	150	154	1082	1553	1082	1553	314	308	350	194	199	
CRI(E)/CRN(E) 15-17	15	1202	1673	1202	1673	314	204	350	167	171	1217	1688	1217	1688	314	308	350	214	219	

CR, CRE 20

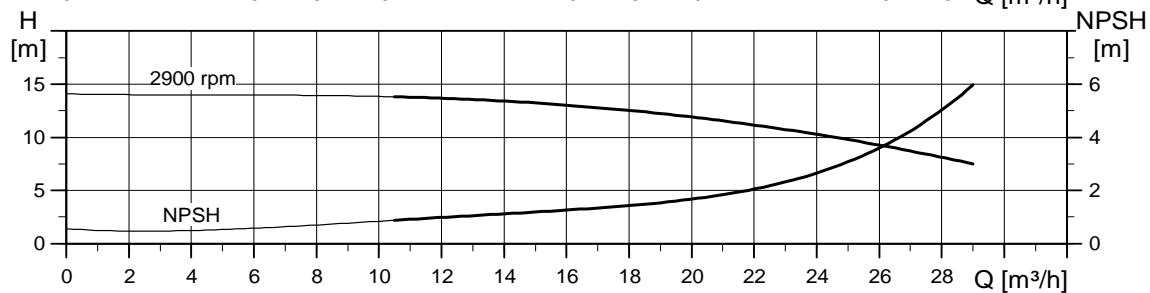
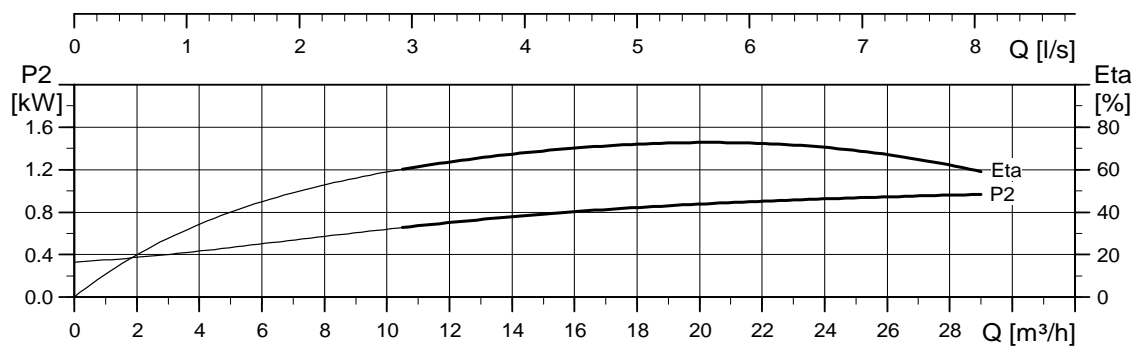
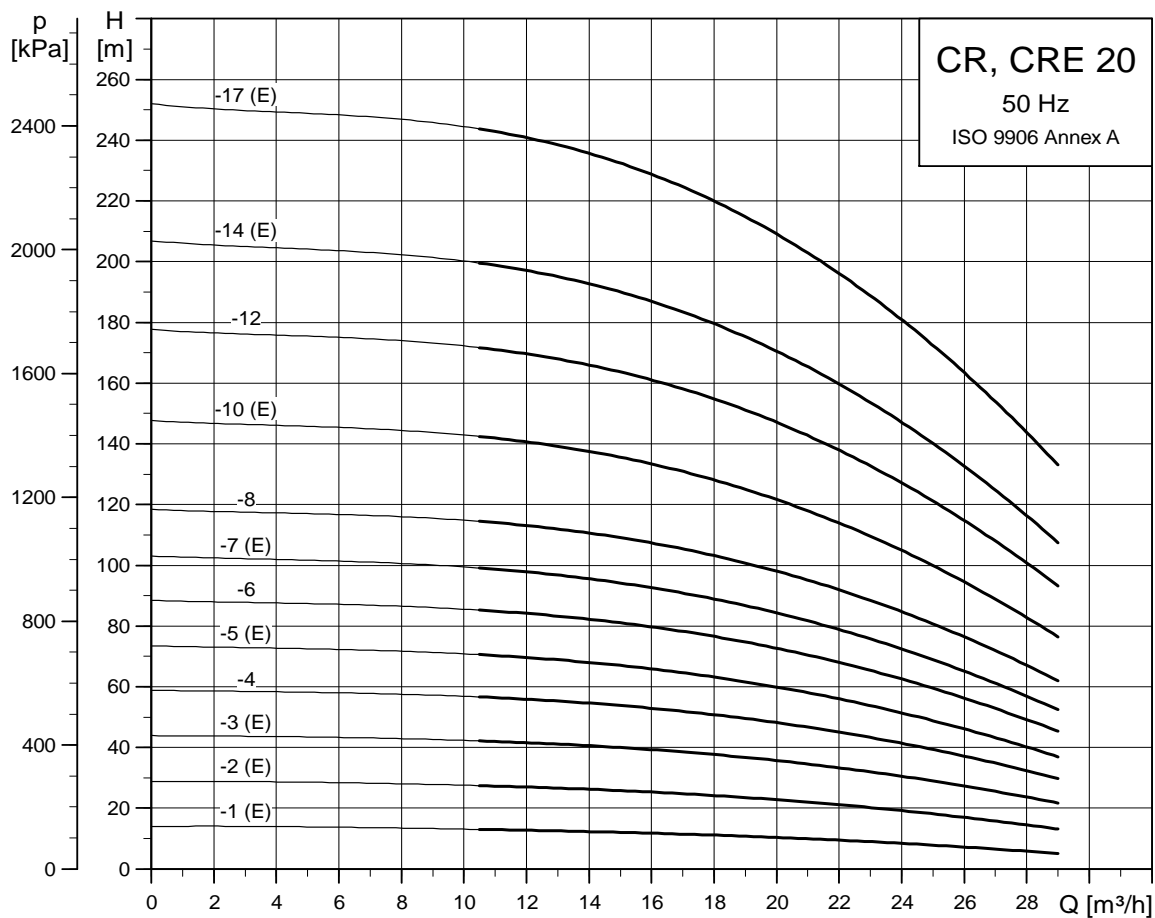

TM02 7300 3605

Dimensional sketch

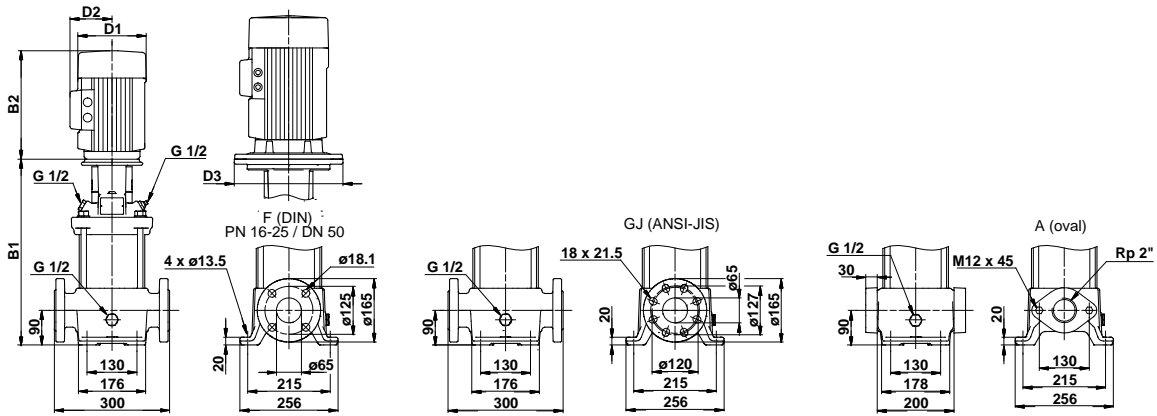

TM03 1727 2805

Dimensions and weights

Pump type	Motor P ₂ [kW]	CR									CRE								
		Dimension [mm]						Net weight [kg]			Dimension [mm]						Net weight [kg]		
		Oval flange		DIN flange				D1	D2	D3	Oval flange	DIN flange	Oval flange	DIN flange	D1	D2	D3	Oval flange	DIN flange
		B1	B1+B2	B1	B1+B2	B1	B1+B2												
CR(E) 20-1	1.1	400	651	400	651	141	109	-	41	42	400	631	400	631	178	167	-	44	45
CR(E) 20-2	2.2	415	736	415	736	178	110	-	49	50	415	736	415	736	178	167	-	59	60
CR(E) 20-3	4	465	837	465	837	220	134	-	65	66	465	837	465	837	220	188	-	75	76
CR 20-4	5.5	542	933	542	933	220	134	300	87	88	-	-	-	-	-	-	-	-	-
CR(E) 20-5	5.5	587	978	587	978	220	134	300	89	90	587	978	587	978	220	188	300	95	96
CR 20-6	7.5	632	1011	632	1011	260	159	300	102	103	-	-	-	-	-	-	-	-	-
CR(E) 20-7	7.5	677	1056	677	1056	260	159	300	104	105	677	1068	677	1068	260	213	300	102	103
CR 20-8	11	-	-	799	1270	314	204	350	-	147	-	-	-	-	-	-	-	-	-
CR(E) 20-10	11	-	-	889	1360	314	204	350	-	150	-	-	904	1375	314	308	350	-	195
CR 20-12	15	-	-	979	1450	314	204	350	-	166	-	-	-	-	-	-	-	-	-
CR(E) 20-14	15	-	-	1069	1540	314	204	350	-	170	-	-	1084	1555	314	308	350	-	217
CR(E) 20-17	18.5	-	-	1204	1719	314	204	350	-	188	-	-	1219	1734	314	308	350	-	234

CRI, CRN, CRIE, CRNE 20

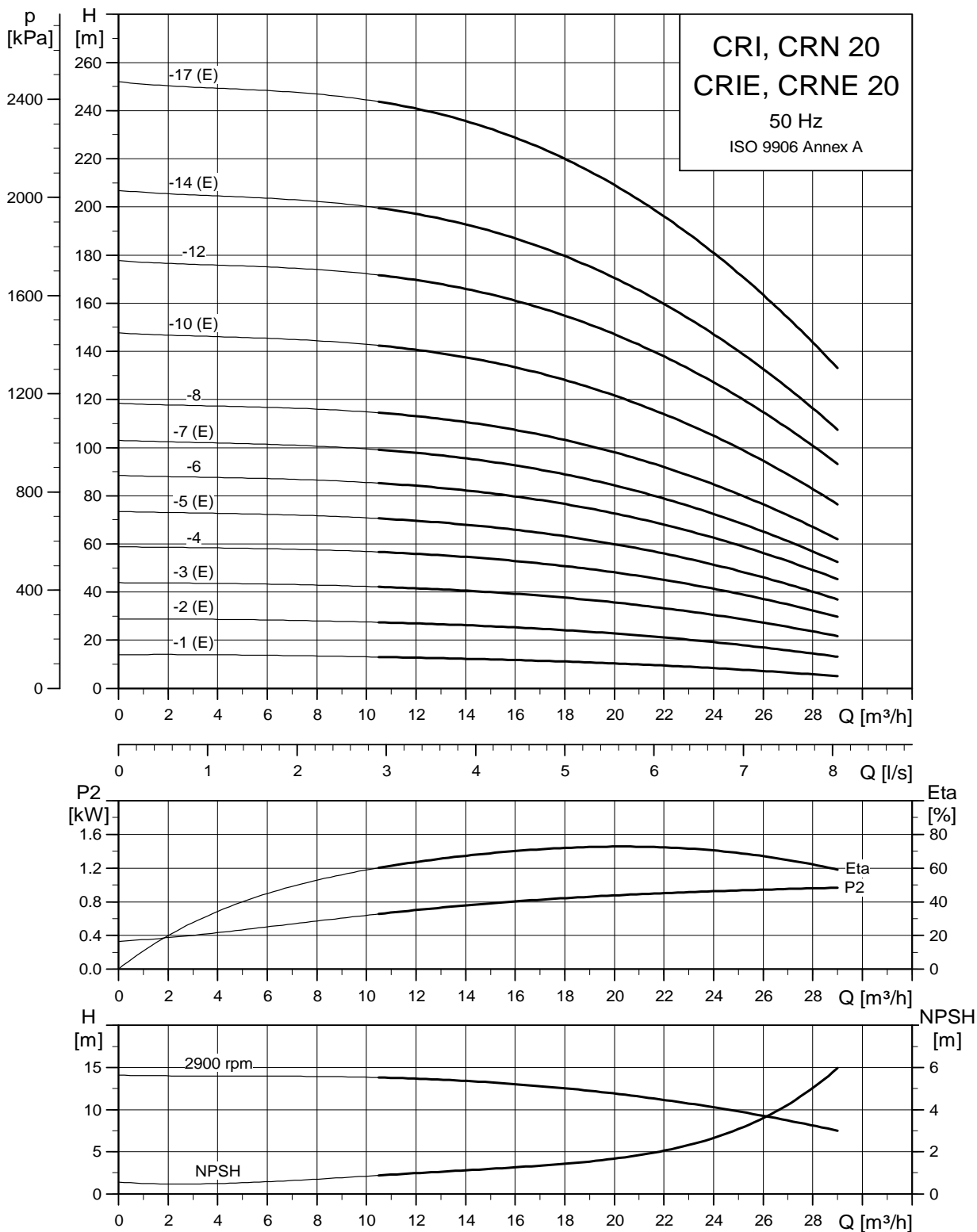

TM02 7301 3605

Dimensional sketch

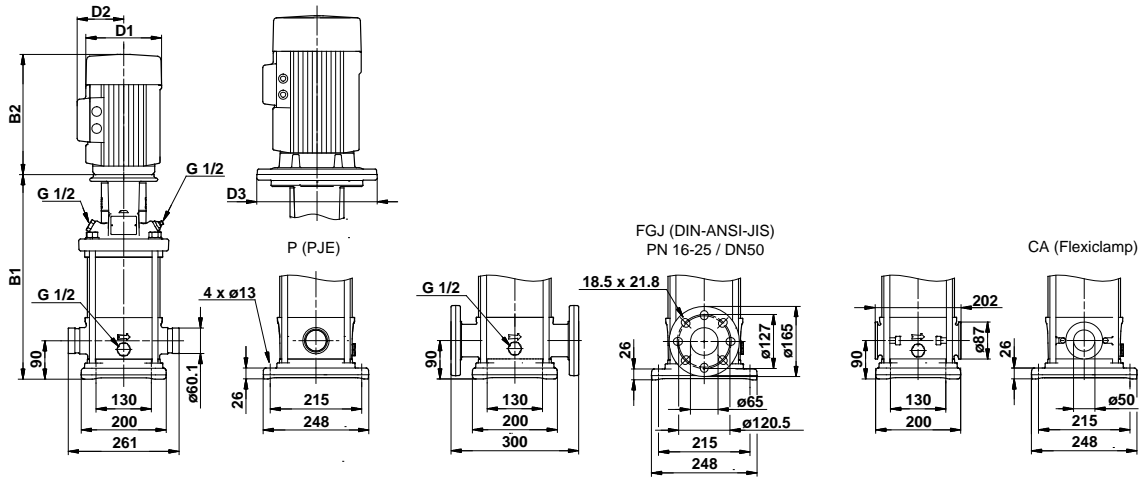

TM03 1728 2805

Dimensions and weights

Pump type	Motor P ₂ [kW]	CRI/CRN									CRIE/CRNE								
		Dimension [mm]						Net weight [kg]			Dimension [mm]						Net weight [kg]		
		PJE/CA		DIN flange		D1	D2	D3	PJE/CA	DIN flange	PJE/CA		DIN flange		D1	D2	D3	PJE/CA	DIN flange
		B1	B1+B2	B1	B1+B2						B1	B1+B2	B1	B1+B2					
CRI(E)/CRN(E) 20-1	1.1	397	648	397	648	141	109	-	34	39	397	628	397	628	178	167	-	37	42
CRI(E)/CRN(E) 20-2	2.2	413	734	413	734	178	110	-	42	47	413	734	413	734	178	167	-	53	57
CRI(E)/CRN(E) 20-3	4	463	835	463	835	220	134	-	59	64	463	835	463	835	220	188	-	69	74
CRI/CRN 20-4	5.5	540	931	540	931	220	134	300	81	86	-	-	-	-	-	-	-	-	-
CRI(E)/CRN(E) 20-5	5.5	585	976	585	976	220	134	300	82	87	585	976	585	976	220	188	300	89	94
CRI/CRN 20-6	7.5	630	1009	630	1009	260	159	300	96	101	-	-	-	-	-	-	-	-	-
CRI(E)/CRN(E) 20-7	7.5	675	1054	675	1054	260	159	300	98	101	675	1066	675	1066	260	213	300	96	100
CRI/CRN 20-8	11	797	1268	797	1268	314	204	350	139	144	-	-	-	-	-	-	-	-	-
CRI(E)/CRN(E) 20-10	11	887	1358	887	1358	314	204	350	143	148	902	1373	902	1373	314	308	350	188	192
CRI/CRN 20-12	15	977	1448	977	1448	314	204	350	158	163	-	-	-	-	-	-	-	-	-
CRI(E)/CRN(E) 20-14	15	1067	1538	1067	1538	314	204	350	162	166	1082	1553	1082	1553	314	308	350	209	214
CRI(E)/CRN(E) 20-17	18.5	1202	1717	1202	1717	314	204	350	180	184	1217	1732	1217	1732	314	308	350	226	231

CR, CRE 32

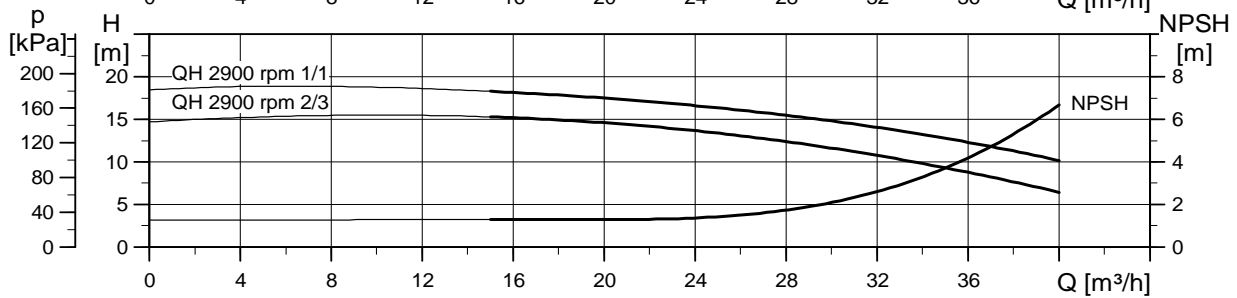
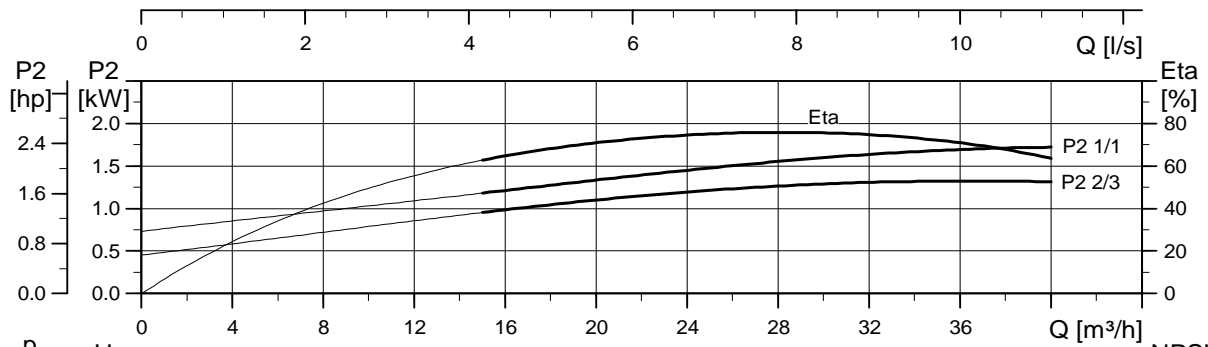
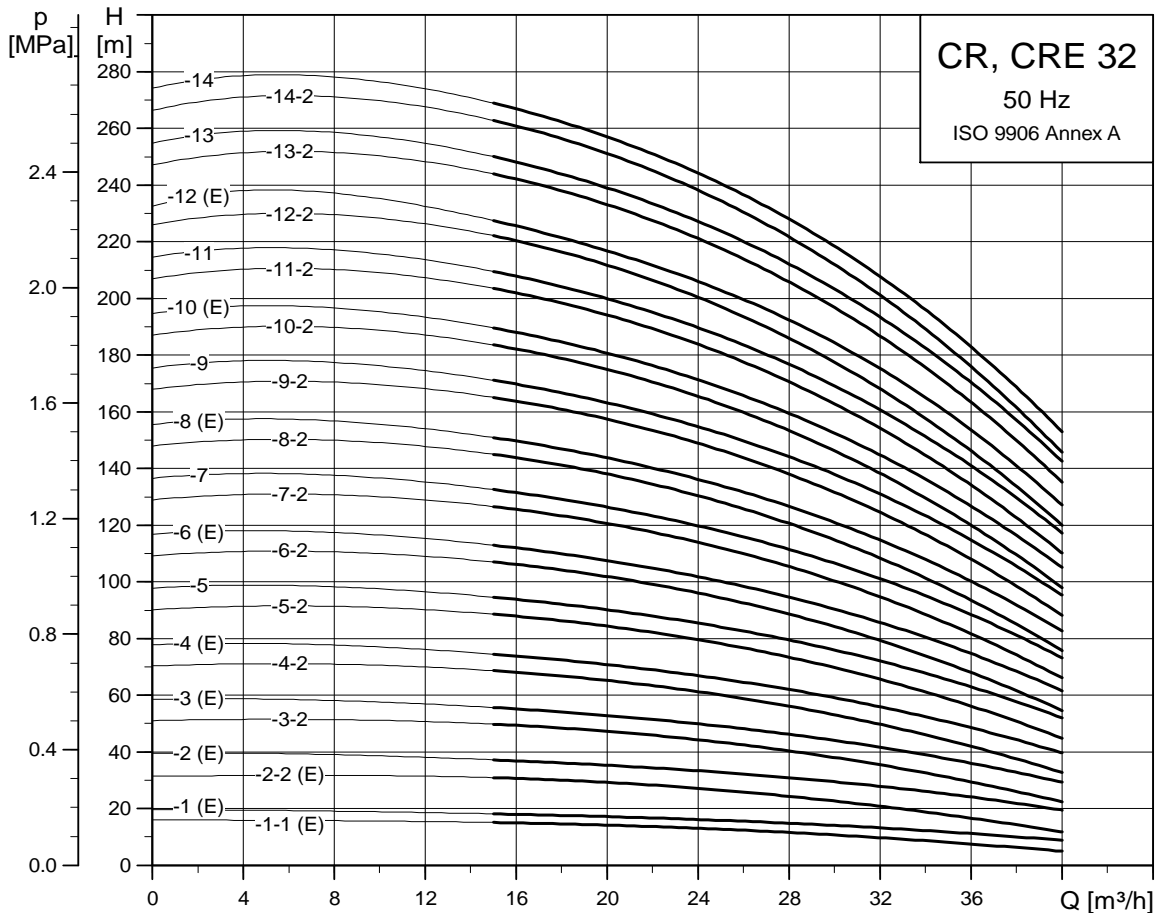

TM02 7302 3605

Dimensional sketch

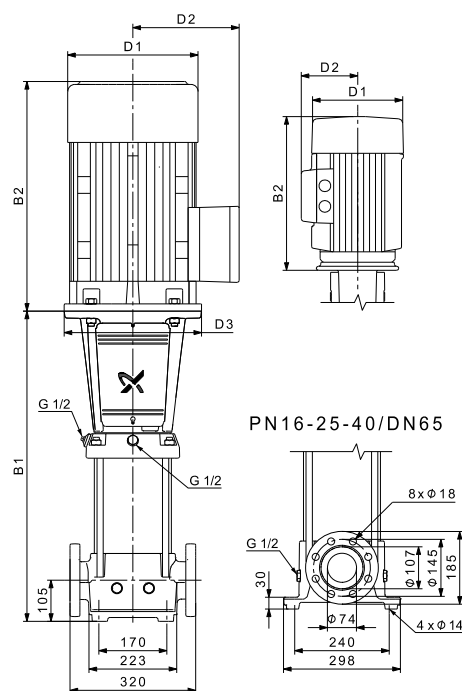

TM01 1749 3298

Dimensions and weights

Pump type	Motor P ₂ [kW]	CR						CRE					
		Dimension [mm]					Net weight [kg]	Dimension [mm]					Net weight [kg]
		B1	B1+B2	D1	D2	D3		B1	B1+B2	D1	D2	D3	
CR(E) 32-1-1	1.5	505	786	178	110	270	64	505	786	178	167	270	70
CR(E) 32-1	2.2	505	826	178	110	270	64	505	826	178	167	270	74
CR(E) 32-2-2	3	575	910	198	120	270	73	575	910	198	177	270	81
CR(E) 32-2	4	575	947	220	134	270	82	575	947	220	188	270	92
CR 32-3-2	5.5	645	1036	220	134	300	96	-	-	-	-	-	-
CR(E) 32-3	5.5	645	1036	220	134	300	96	645	1036	220	188	300	103
CR 32-4-2	7.5	715	1094	260	159	300	111	-	-	-	-	-	-
CR(E) 32-4	7.5	715	1094	260	159	300	111	715	1106	260	213	300	109
CR 32-5-2	11	895	1366	314	204	350	159	-	-	-	-	-	-
CR 32-5	11	895	1366	314	204	350	159	-	-	-	-	-	-
CR 32-6-2	11	965	1436	314	204	350	162	-	-	-	-	-	-
CR(E) 32-6	11	965	1436	314	204	350	162	965	1436	314	308	350	191
CR 32-7-2	15	1035	1506	314	204	350	177	-	-	-	-	-	-
CR 32-7	15	1035	1506	314	204	350	177	-	-	-	-	-	-
CR 32-8-2	15	1105	1576	314	204	350	183	-	-	-	-	-	-
CR(E) 32-8	15	1105	1576	314	204	350	183	1105	1576	314	308	350	215
CR 32-9-2	18.5	1175	1690	314	204	350	200	-	-	-	-	-	-
CR 32-9	18.5	1175	1690	314	204	350	200	-	-	-	-	-	-
CR 32-10-2	18.5	1245	1760	314	204	350	203	-	-	-	-	-	-
CR(E) 32-10	18.5	1245	1760	314	204	350	203	1245	1760	314	308	350	234
CR 32-11-2	22	1315	1856	314	204	350	220	-	-	-	-	-	-
CR 32-11	22	1315	1856	314	204	350	220	-	-	-	-	-	-
CR 32-12-2	22	1385	1926	314	204	350	224	-	-	-	-	-	-
CR(E) 32-12	22	1385	1926	314	204	350	224	1385	1926	314	308	350	254
CR 32-13-2	30	1455	2065	407	315	400	329	-	-	-	-	-	-
CR 32-13	30	1455	2065	407	315	400	329	-	-	-	-	-	-
CR 32-14-2	30	1525	2135	407	315	400	332	-	-	-	-	-	-
CR 32-14	30	1525	2135	407	315	400	332	-	-	-	-	-	-

CRN, CRNE 32

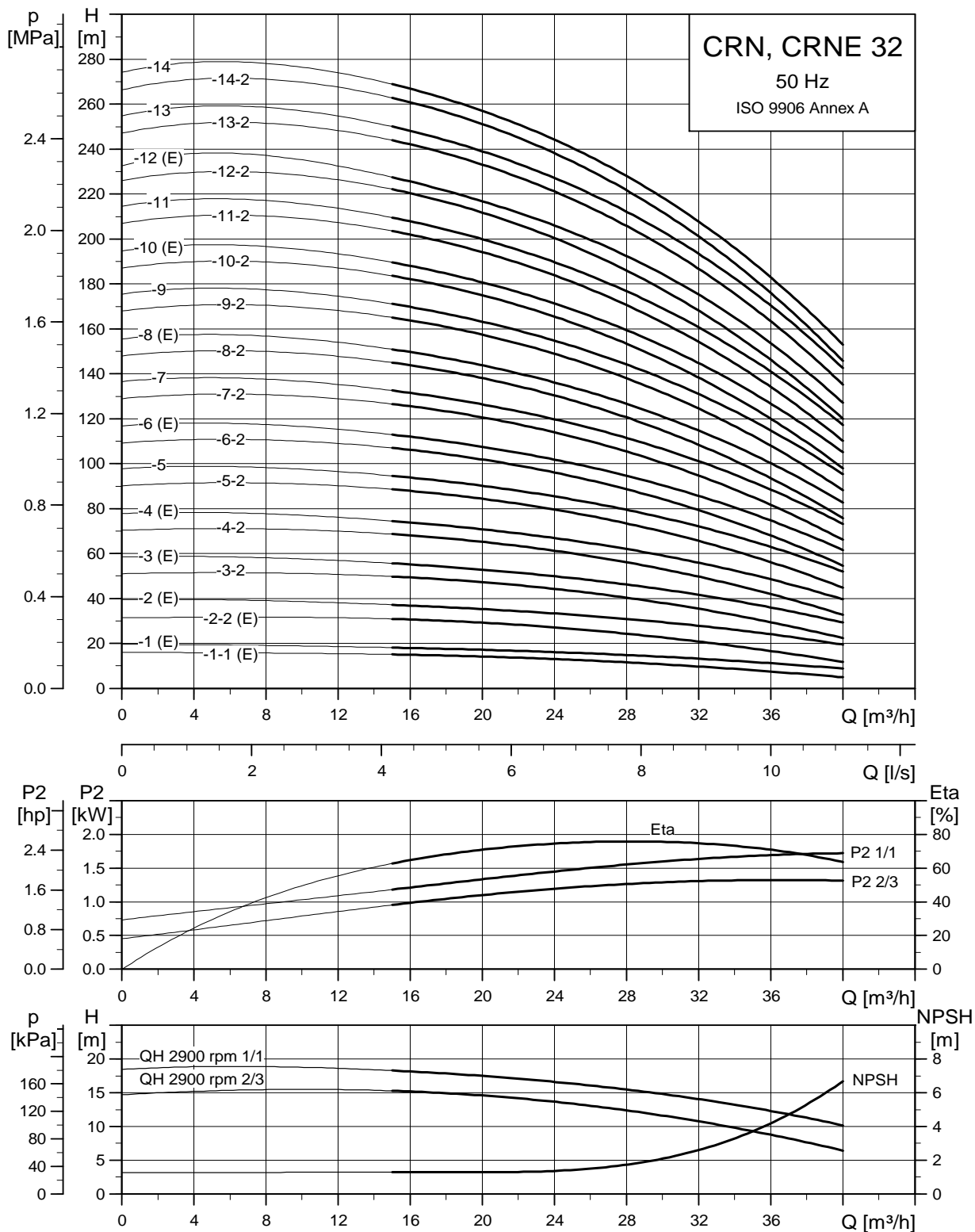

TM02 7303 3605

Dimensional sketch

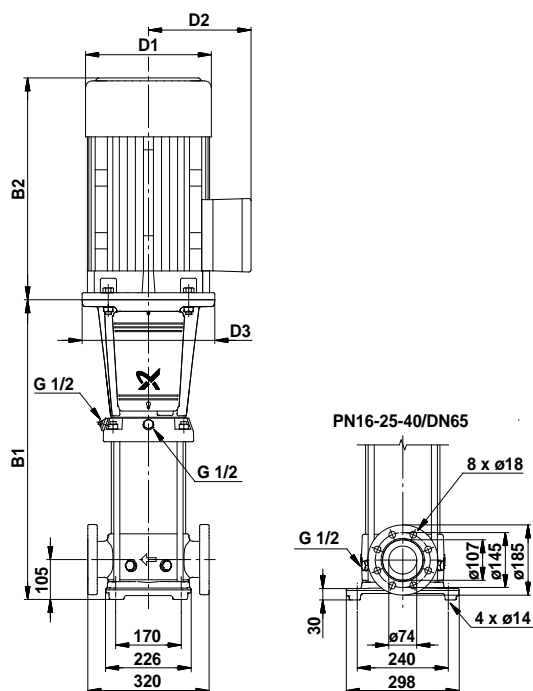

TM01 1750 2203

Dimensions and weights

Pump type	Motor P ₂ [kW]	CRN						Net weight [kg]	CRNE					Net weight [kg]
		Dimension [mm]					B1		B1+B2	D1	D2	D3		
B1	B1+B2	D1	D2	D3	B1	B1+B2		D1					D2	D3
CRN(E) 32-1-1	1.5	505	786	178	110	270	66	505	786	178	167	270	73	
CRN(E) 32-1	2.2	505	826	178	110	270	66	505	826	178	167	270	77	
CRN(E) 32-2-2	3	575	910	198	120	270	75	575	910	198	177	270	83	
CRN(E) 32-2	4	575	947	220	134	270	84	575	947	220	188	270	94	
CRN 32-3-2	5.5	645	1036	220	134	300	99	-	-	-	-	-	-	
CRN(E) 32-3	5.5	645	1036	220	134	300	99	645	1036	220	188	300	105	
CRN 32-4-2	7.5	715	1094	260	159	300	114	-	-	-	-	-	-	
CRN(E) 32-4	7.5	715	1094	260	159	300	114	715	1106	260	213	300	111	
CRN 32-5-2	11	895	1366	314	204	350	160	-	-	-	-	-	-	
CRN 32-5	11	895	1366	314	204	350	160	-	-	-	-	-	-	
CRN 32-6-2	11	965	1436	314	204	350	163	-	-	-	-	-	-	
CRN(E) 32-6	11	965	1436	314	204	350	163	965	1436	314	308	350	193	
CRN 32-7-2	15	1035	1506	314	204	350	179	-	-	-	-	-	-	
CRN 32-7	15	1035	1506	314	204	350	179	-	-	-	-	-	-	
CRN 32-8-2	15	1105	1576	314	204	350	185	-	-	-	-	-	-	
CRN(E) 32-8	15	1105	1576	314	204	350	185	1105	1576	314	308	350	217	
CRN 32-9-2	18.5	1175	1690	314	204	350	202	-	-	-	-	-	-	
CRN 32-9	18.5	1175	1690	314	204	350	202	-	-	-	-	-	-	
CRN 32-10-2	18.5	1245	1760	314	204	350	205	-	-	-	-	-	-	
CRN(E) 32-10	18.5	1245	1760	314	204	350	205	1245	1760	314	308	350	236	
CRN 32-11-2	22	1315	1856	314	204	350	222	-	-	-	-	-	-	
CRN 32-11	22	1315	1856	314	204	350	222	-	-	-	-	-	-	
CRN 32-12-2	22	1385	1926	314	204	350	226	-	-	-	-	-	-	
CRN(E) 32-12	22	1385	1926	314	204	350	226	1385	1926	314	308	350	256	
CRN 32-13-2	30	1455	2065	407	315	400	331	-	-	-	-	-	-	
CRN 32-13	30	1455	2065	407	315	400	331	-	-	-	-	-	-	
CRN 32-14-2	30	1525	2135	407	315	400	335	-	-	-	-	-	-	
CRN 32-14	30	1525	2135	407	315	400	335	-	-	-	-	-	-	

CR, CRE 45

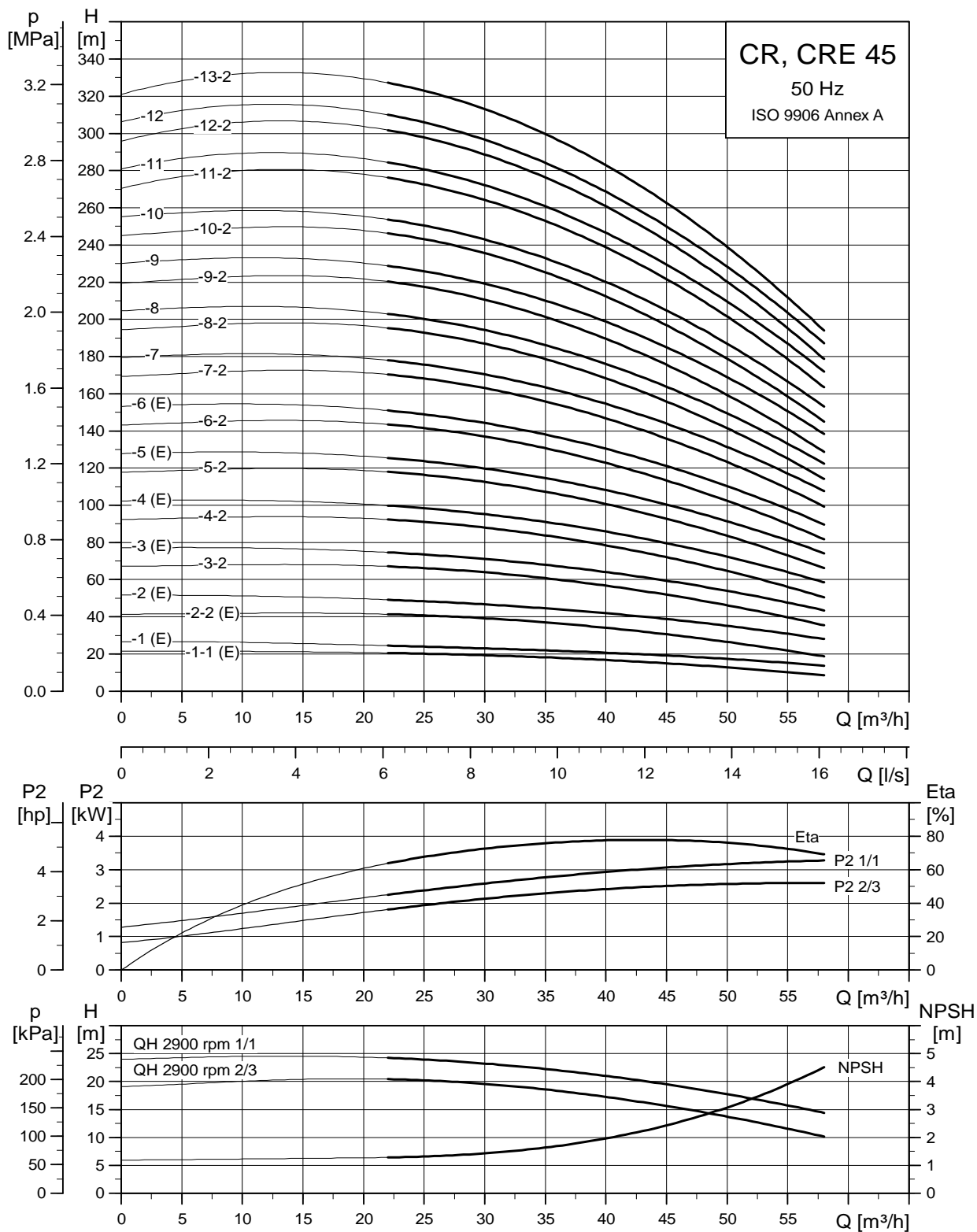

TM02 7304 3605

Dimensional sketch

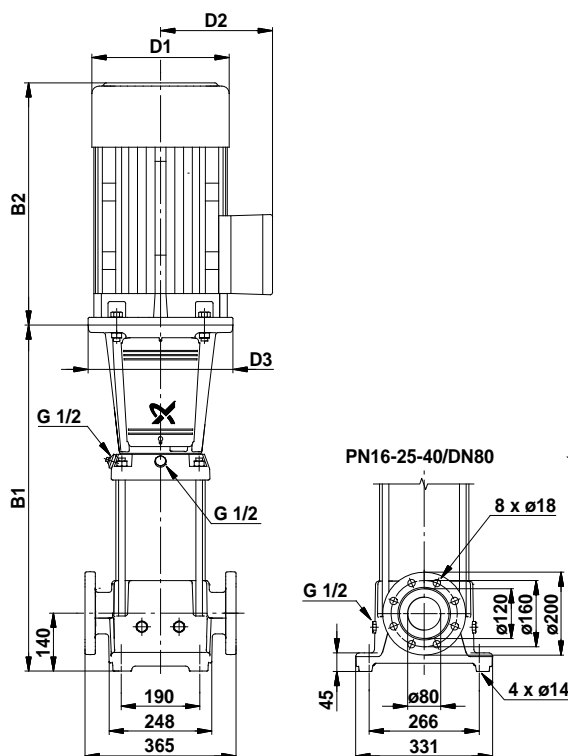

TMO1 1751 3203

Dimensions and weights

Pump type	Motor P ₂ [kW]	CR					Net weight [kg]	CRE					Net weight [kg]
		B1	B1+B2	D1	D2	D3		B1	B1+B2	D1	D2	D3	
CR(E) 45-1-1	3	559	894	198	120	270	80	559	894	198	177	270	88
CR(E) 45-1	4	559	931	220	134	270	89	559	931	220	188	270	99
CR(E) 45-2-2	5.5	639	1030	220	134	300	104	639	1030	220	188	300	110
CR(E) 45-2	7.5	639	1018	260	159	300	116	639	1030	260	213	300	114
CR 45-3-2	11	829	1300	314	204	350	163	-	-	-	-	-	-
CR(E) 45-3	11	829	1300	314	204	350	163	829	1300	314	308	350	193
CR 45-4-2	15	909	1380	314	204	350	180	-	-	-	-	-	-
CR(E) 45-4	15	909	1380	314	204	350	180	909	1380	314	308	350	212
CR 45-5-2	18.5	989	1504	314	204	350	197	-	-	-	-	-	-
CR(E) 45-5	18.5	989	1504	314	204	350	197	989	1504	314	308	350	228
CR 45-6-2	22	1069	1610	314	204	350	217	-	-	-	-	-	-
CR(E) 45-6	22	1069	1610	314	204	350	217	1069	1610	314	308	350	247
CR 45-7-2	30	1149	1759	407	315	400	324	-	-	-	-	-	-
CR 45-7	30	1149	1759	407	315	400	324	-	-	-	-	-	-
CR 45-8-2	30	1229	1839	407	315	400	328	-	-	-	-	-	-
CR 45-8	30	1229	1839	407	315	400	328	-	-	-	-	-	-
CR 45-9-2	30	1309	1919	407	315	400	332	-	-	-	-	-	-
CR 45-9	37	1309	1976	407	315	400	362	-	-	-	-	-	-
CR 45-10-2	37	1389	2056	407	315	400	367	-	-	-	-	-	-
CR 45-10	37	1389	2056	407	315	400	367	-	-	-	-	-	-
CR 45-11-2	45	1469	2177	439	338	450	455	-	-	-	-	-	-
CR 45-11	45	1469	2177	439	338	450	455	-	-	-	-	-	-
CR 45-12-2	45	1549	2257	439	338	450	460	-	-	-	-	-	-
CR 45-12	45	1549	2257	439	338	450	460	-	-	-	-	-	-
CR 45-13-2	45	1629	2337	439	338	450	464	-	-	-	-	-	-

CRN, CRNE 45

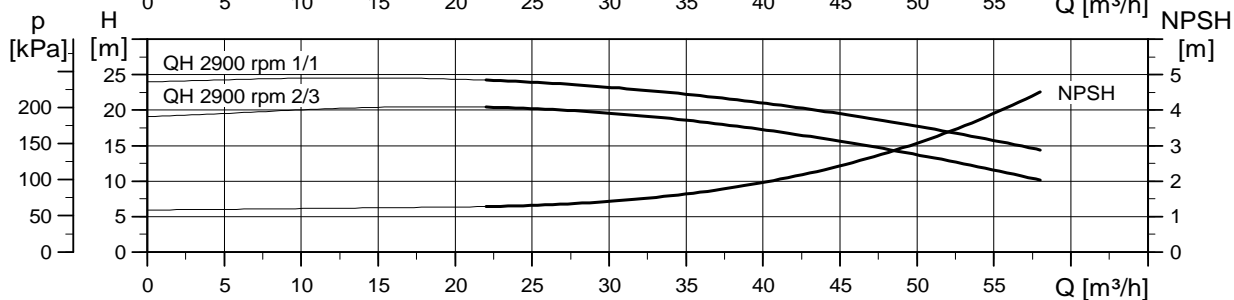
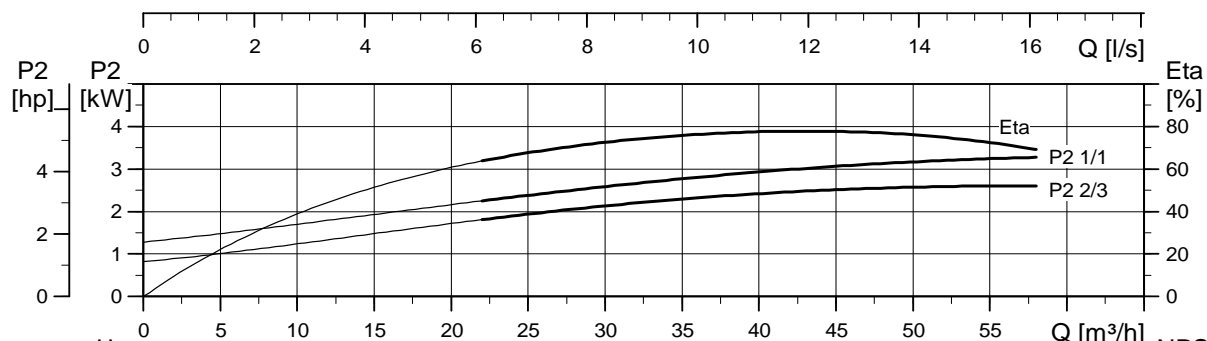
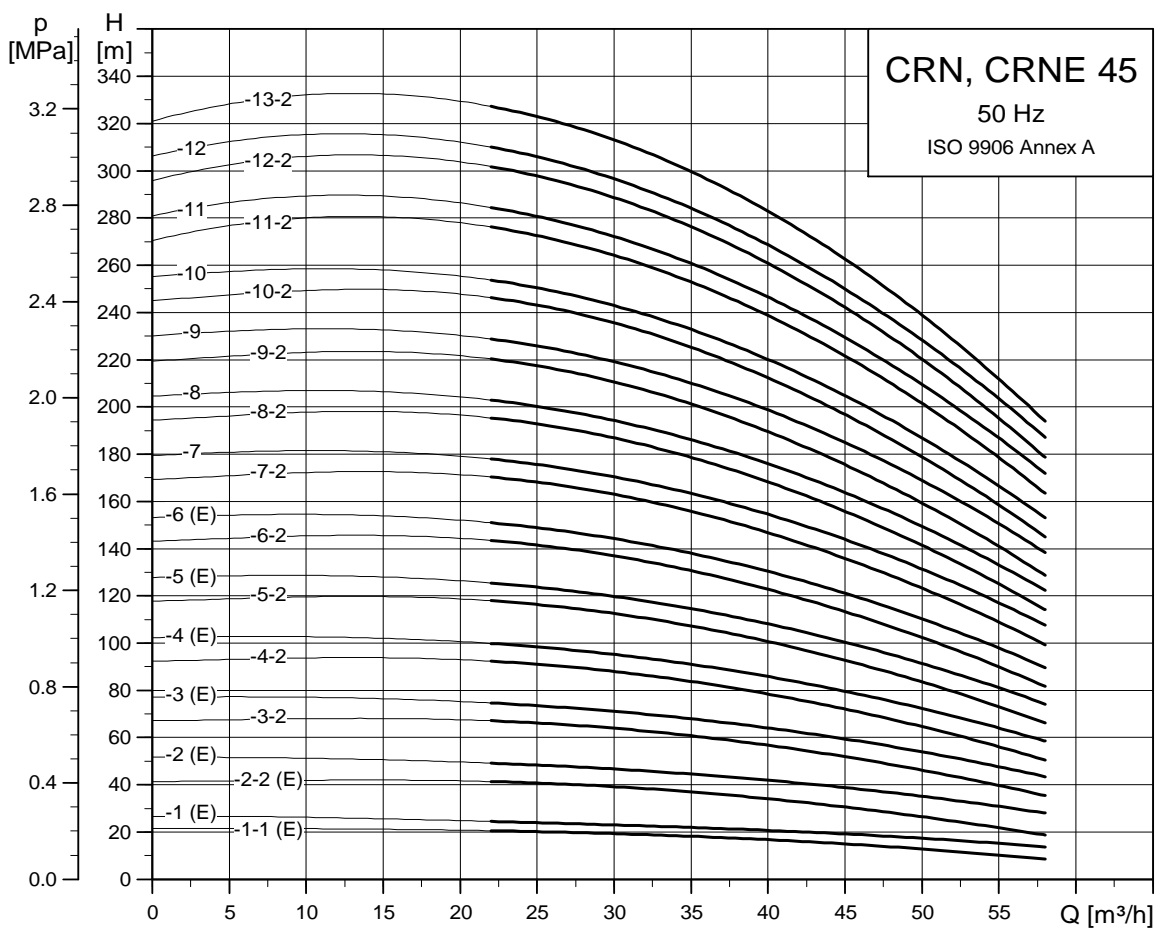

TM02 7305 3605

Dimensional sketch

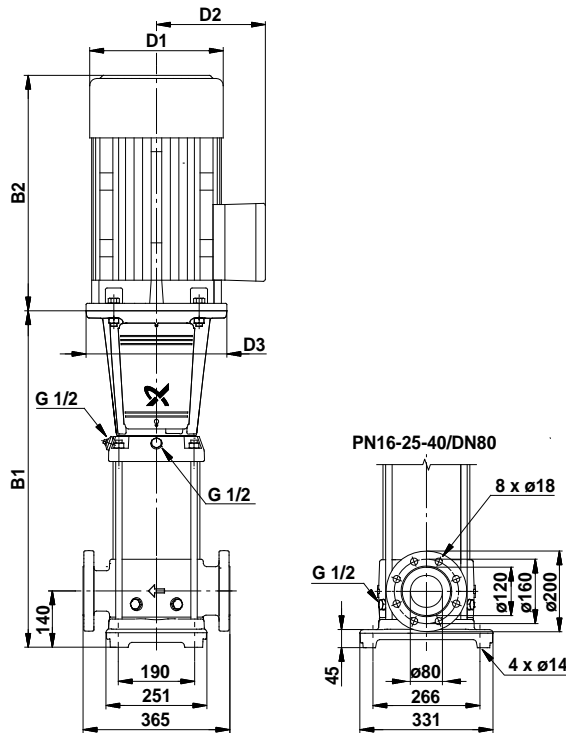

TM01 1752 3203

Dimensions and weights

Pump type	Motor P ₂ [kW]	CRN						Net weight [kg]	CRNE					Net weight [kg]
		Dimension [mm]					B1		B1+B2	D1	D2	D3		
CRN(E) 45-1-1	3	559	894	198	120	270		80					559	894
CRN(E) 45-1	4	559	931	220	134	270	89	559	931	220	188	270	99	
CRN(E) 45-2-2	5.5	639	1030	220	134	300	104	639	1030	220	188	300	111	
CRN(E) 45-2	7.5	639	1018	260	159	300	116	639	1030	260	213	300	114	
CRN 45-3-2	11	829	1300	314	204	350	164	-	-	-	-	-	-	
CRN(E) 45-3	11	829	1300	314	204	350	164	829	1300	314	308	350	194	
CRN 45-4-2	15	909	1380	314	204	350	180	-	-	-	-	-	-	
CRN(E) 45-4	15	909	1380	314	204	350	180	909	1380	314	308	350	212	
CRN 45-5-2	18.5	989	1504	314	204	350	197	-	-	-	-	-	-	
CRN(E) 45-5	18.5	989	1504	314	204	350	197	989	1504	314	308	350	228	
CRN 45-6-2	22	1069	1610	314	204	350	218	-	-	-	-	-	-	
CRN(E) 45-6	22	1069	1610	314	204	350	218	1069	1610	314	308	350	248	
CRN 45-7-2	30	1149	1759	407	315	400	324	-	-	-	-	-	-	
CRN 45-7	30	1149	1759	407	315	400	324	-	-	-	-	-	-	
CRN 45-8-2	30	1229	1839	407	315	400	328	-	-	-	-	-	-	
CRN 45-8	30	1229	1839	407	315	400	328	-	-	-	-	-	-	
CRN 45-9-2	30	1309	1919	407	315	400	333	-	-	-	-	-	-	
CRN 45-9	37	1309	1976	407	315	400	363	-	-	-	-	-	-	
CRN 45-10-2	37	1389	2056	407	315	400	367	-	-	-	-	-	-	
CRN 45-10	37	1389	2056	407	315	400	367	-	-	-	-	-	-	
CRN 45-11-2	45	1469	2177	439	338	450	455	-	-	-	-	-	-	
CRN 45-11	45	1469	2177	439	338	450	455	-	-	-	-	-	-	
CRN 45-12-2	45	1549	2257	439	338	450	460	-	-	-	-	-	-	
CRN 45-12	45	1549	2257	439	338	450	460	-	-	-	-	-	-	
CRN 45-13-2	45	1629	2337	439	338	450	464	-	-	-	-	-	-	

CR, CRE 64

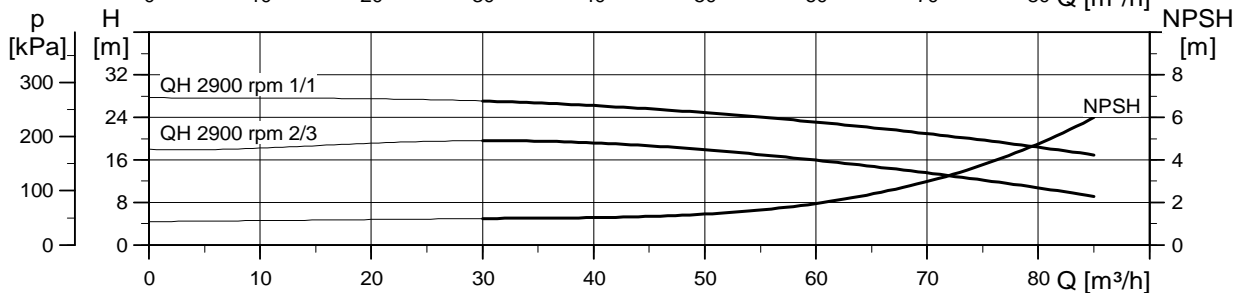
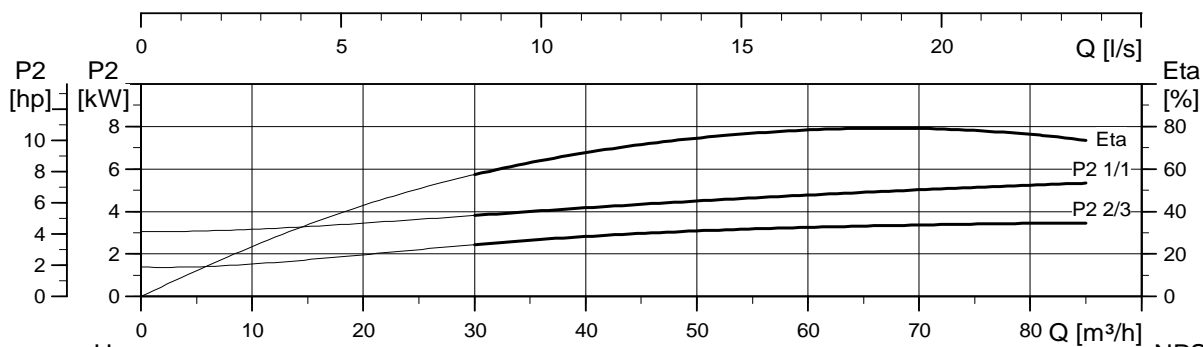
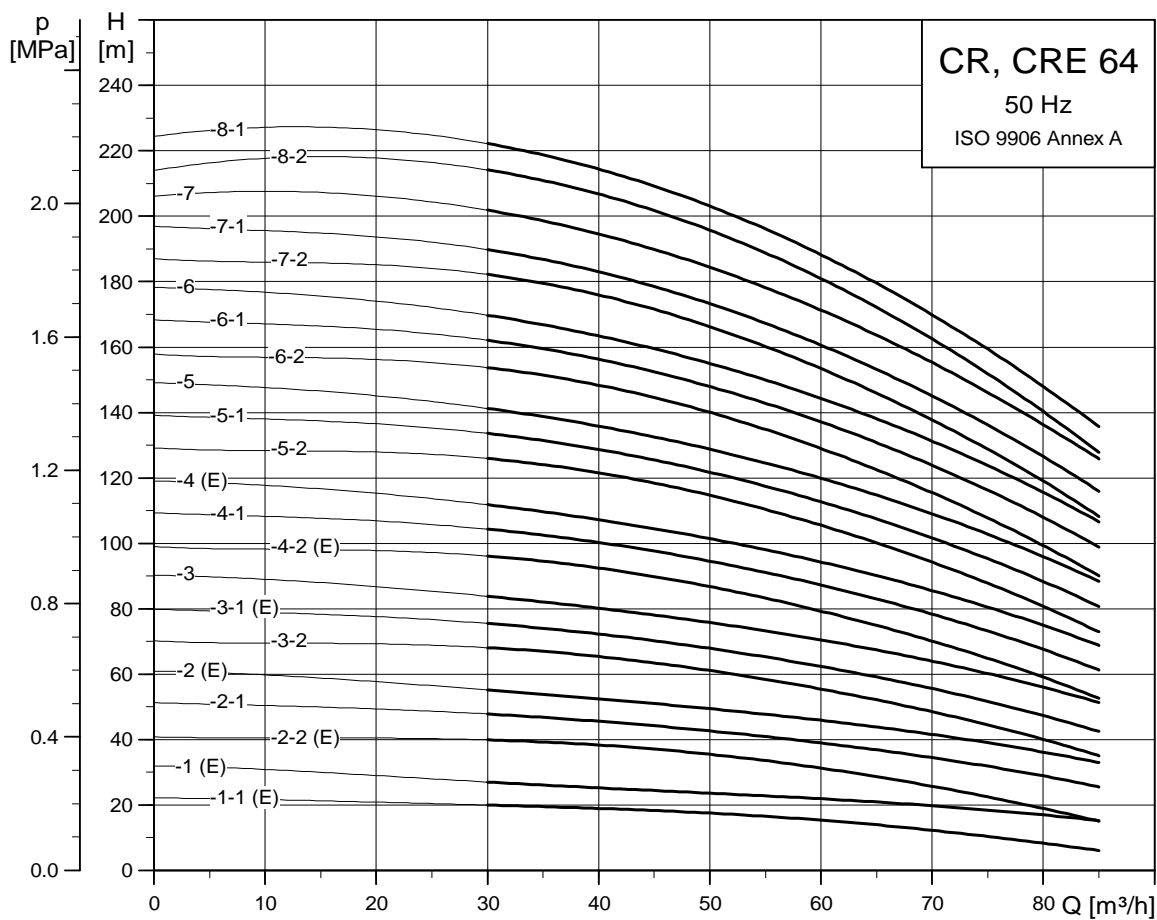

TM02 7306 3605

Dimensional sketch

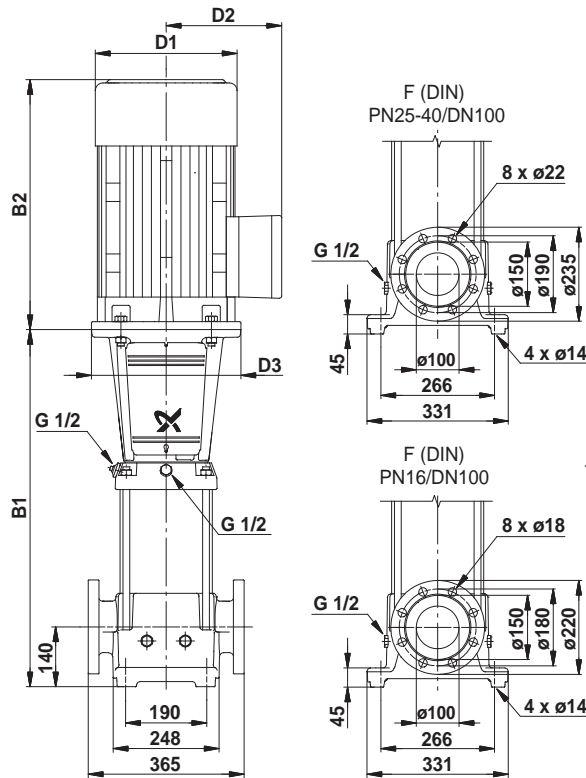

TM01 1753 5197

Dimensions and weights

Pump type	Motor P ₂ [kW]	CR						CRE					
		Dimension [mm]					Net weight [kg]	Dimension [mm]					Net weight [kg]
		B1	B1+B2	D1	D2	D3		B1	B1+B2	D1	D2	D3	
CR(E) 64-1-1	4	561	933	220	134	270	91	561	933	220	188	270	101
CR(E) 64-1	5.5	561	952	220	134	300	102	561	952	220	188	300	109
CR(E) 64-2-2	7.5	644	1023	260	159	300	119	644	1035	260	213	300	117
CR 64-2-1	11	754	1225	314	204	350	162	-	-	-	-	-	-
CR(E) 64-2	11	754	1225	314	204	350	162	754	1225	314	308	350	192
CR 64-3-2	15	836	1307	314	204	350	180	-	-	-	-	-	-
CR(E) 64-3-1	15	836	1307	314	204	350	180	836	1307	314	308	350	212
CR 64-3	18.5	836	1351	314	204	350	193	-	-	-	-	-	-
CR(E) 64-4-2	18.5	919	1434	314	204	350	197	919	1434	314	308	350	228
CR 64-4-1	22	919	1460	314	204	350	211	-	-	-	-	-	-
CR(E) 64-4	22	919	1460	314	204	350	211	919	1460	314	308	350	241
CR 64-5-2	30	1001	1611	407	315	400	318	-	-	-	-	-	-
CR 64-5-1	30	1001	1611	407	315	400	318	-	-	-	-	-	-
CR 64-5	30	1001	1611	407	315	400	318	-	-	-	-	-	-
CR 64-6-2	30	1084	1694	407	315	400	324	-	-	-	-	-	-
CR 64-6-1	37	1084	1751	407	315	400	354	-	-	-	-	-	-
CR 64-6	37	1084	1751	407	315	400	354	-	-	-	-	-	-
CR 64-7-2	37	1166	1833	407	315	400	359	-	-	-	-	-	-
CR 64-7-1	37	1166	1833	407	315	400	359	-	-	-	-	-	-
CR 64-7	45	1166	1874	439	338	450	443	-	-	-	-	-	-
CR 64-8-2	45	1249	1957	439	338	450	448	-	-	-	-	-	-
CR 64-8-1	45	1249	1957	439	338	450	448	-	-	-	-	-	-

CRN, CRNE 64

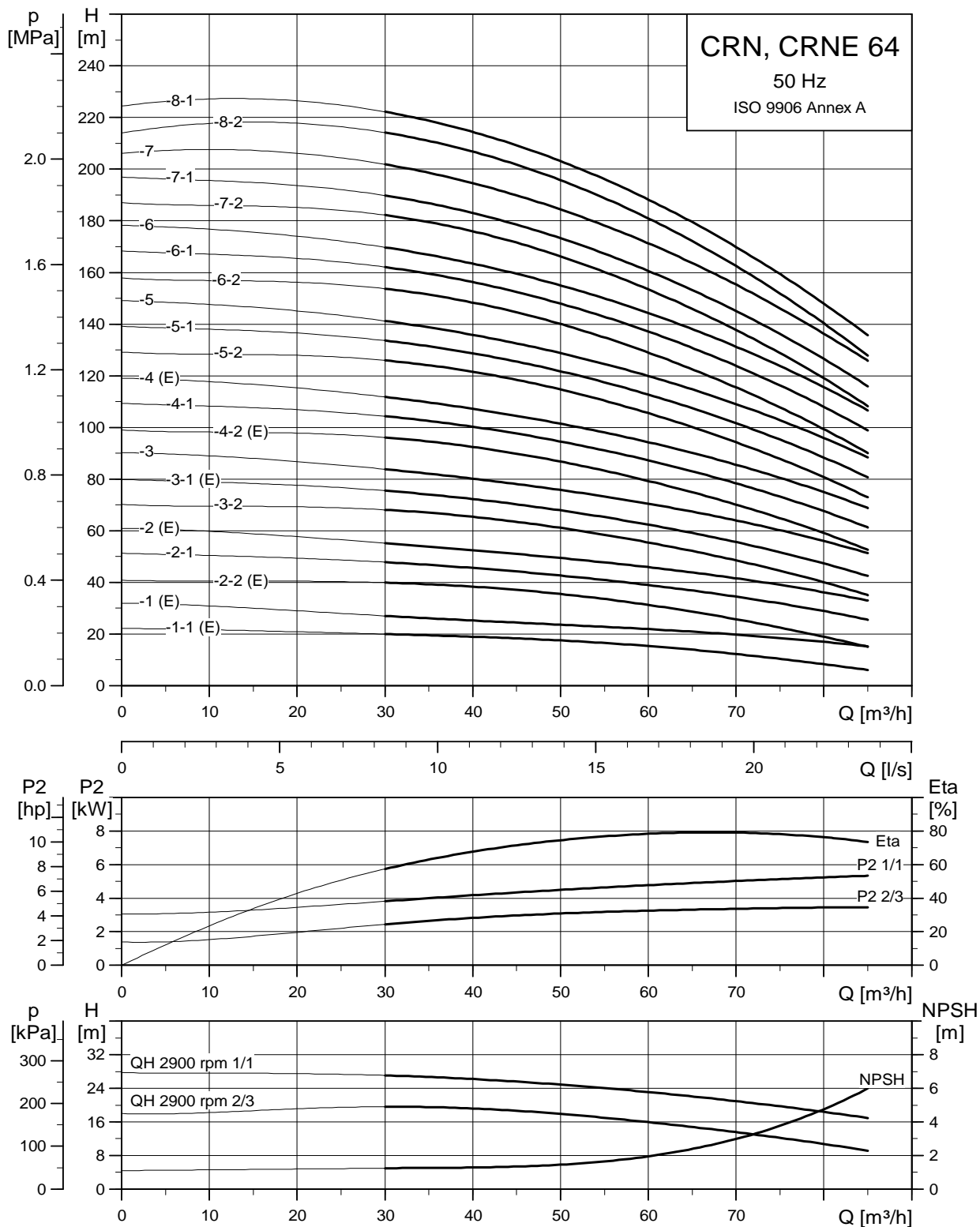

TM02 7307 3605

Dimensional sketch

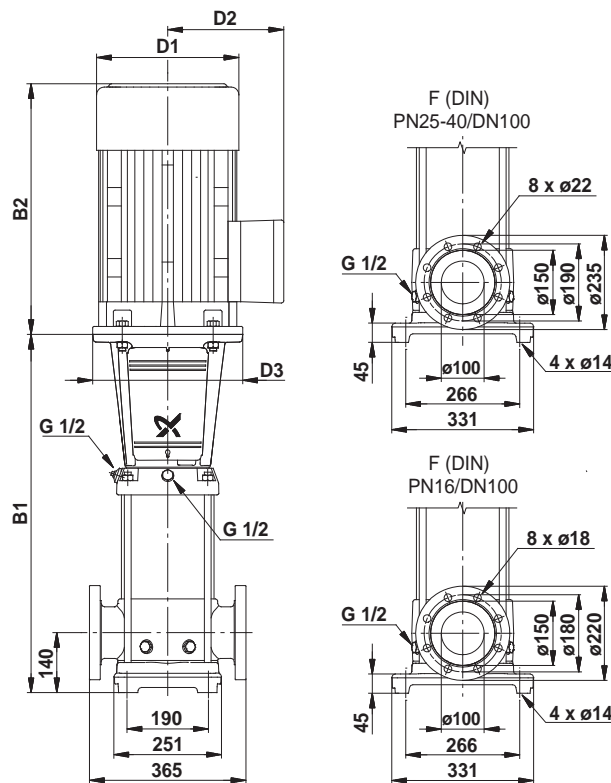

TM01 1754 0904

Dimensions and weights

Pump type	Motor P ₂ [kW]	CRN						CRNE					
		Dimension [mm]					Net weight [kg]	Dimension [mm]					Net weight [kg]
		B1	B1+B2	D1	D2	D3		B1	B1+B2	D1	D2	D3	
CRN(E) 64-1-1	4	561	933	220	134	270	91	561	933	220	188	270	101
CRN(E) 64-1	5.5	561	952	220	134	300	102	561	952	220	188	300	109
CRN(E) 64-2-2	7.5	644	1023	260	159	300	119	644	1035	260	213	300	116
CRN 64-2-1	11	754	1225	314	204	350	162	-	-	-	-	-	-
CRN(E) 64-2	11	754	1225	314	204	350	162	754	1225	314	308	350	192
CRN 64-3-2	15	836	1307	314	204	350	180	-	-	-	-	-	-
CRN(E) 64-3-1	15	836	1307	314	204	350	180	836	1307	314	308	350	212
CRN 64-3	18.5	836	1351	314	204	350	193	-	-	-	-	-	-
CRN(E) 64-4-2	18.5	919	1434	314	204	350	197	919	1434	314	308	350	228
CRN 64-4-1	22	919	1460	314	204	350	211	-	-	-	-	-	-
CRN(E) 64-4	22	919	1460	314	204	350	211	919	1460	314	308	350	241
CRN 64-5-2	30	1001	1611	407	315	400	318	-	-	-	-	-	-
CRN 64-5-1	30	1001	1611	407	315	400	318	-	-	-	-	-	-
CRN 64-5	30	1001	1611	407	315	400	318	-	-	-	-	-	-
CRN 64-6-2	30	1084	1694	407	315	400	325	-	-	-	-	-	-
CRN 64-6-1	37	1084	1751	407	315	400	355	-	-	-	-	-	-
CRN 64-6	37	1084	1751	407	315	400	355	-	-	-	-	-	-
CRN 64-7-2	37	1166	1833	407	315	400	359	-	-	-	-	-	-
CRN 64-7-1	37	1166	1833	407	315	400	359	-	-	-	-	-	-
CRN 64-7	45	1166	1874	439	338	450	444	-	-	-	-	-	-
CRN 64-8-2	45	1249	1957	439	338	450	448	-	-	-	-	-	-
CRN 64-8-1	45	1249	1957	439	338	450	448	-	-	-	-	-	-

CR, CRE 90

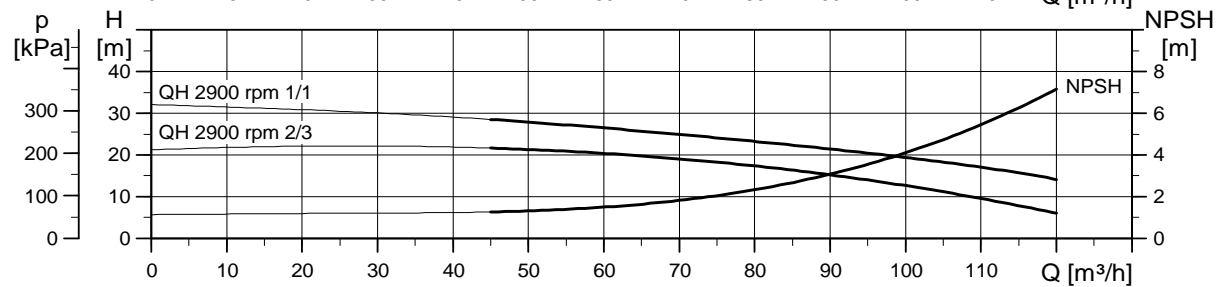
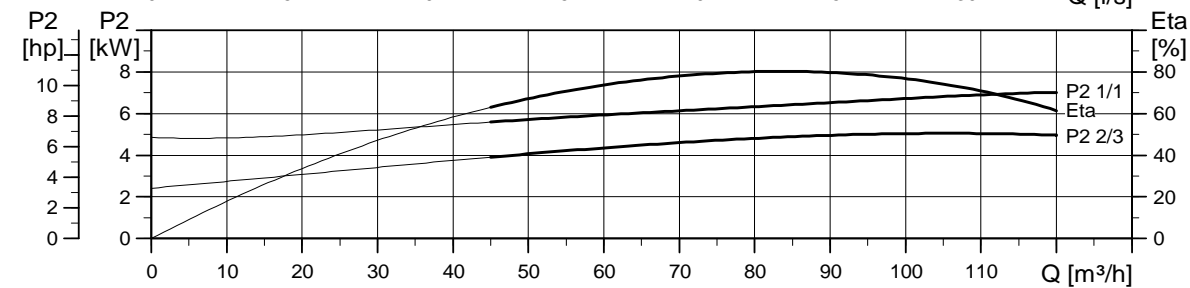
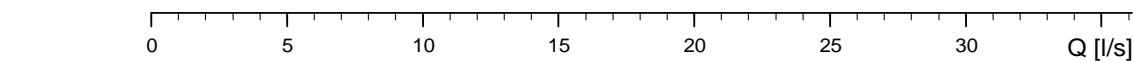
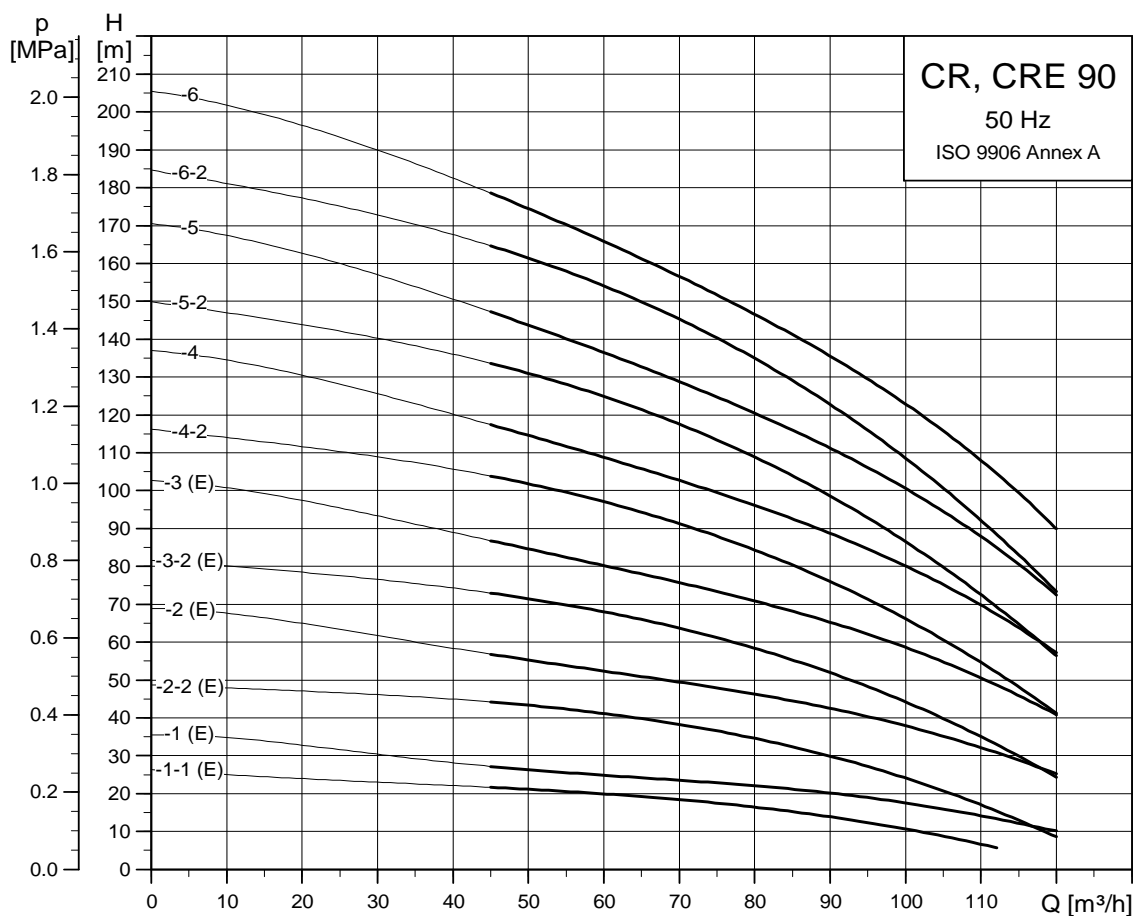

TM02 7308 3605

Dimensional sketch

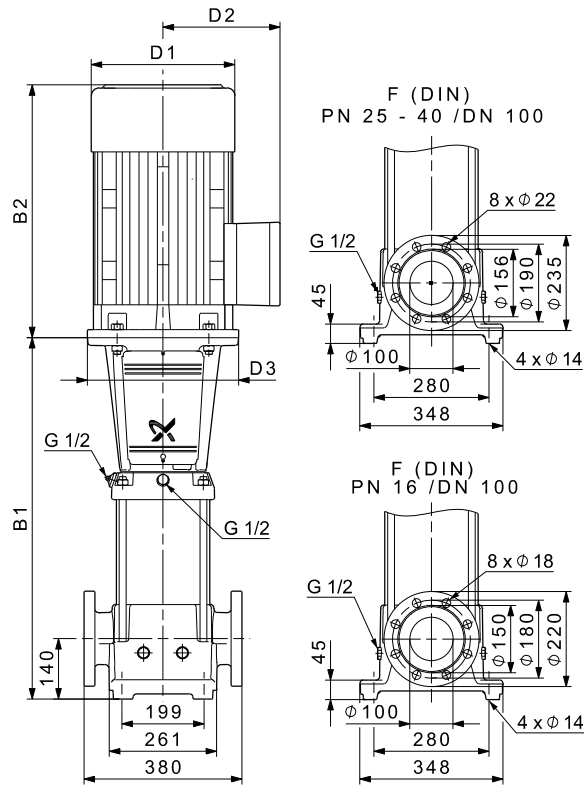

TM01 1755 4809

Dimensions and weights

Pump type	Motor P ₂ [kW]	CR					Net weight [kg]	CRE					Net weight [kg]
		Dimension [mm]						Dimension [mm]					
		B1	B1+B2	D1	D2	D3		B1	B1+B2	D1	D2	D3	
CR(E) 90-1-1	5.5	571	962	220	134	300	107	571	962	220	188	300	114
CR(E) 90-1	7.5	571	950	260	159	300	119	571	962	260	213	300	117
CR(E) 90-2-2	11	773	1244	314	204	350	168	773	1244	314	308	350	198
CR(E) 90-2	15	773	1244	314	204	350	181	773	1244	314	308	350	213
CR(E) 90-3-2	18.5	865	1380	314	204	350	199	865	1380	314	308	350	230
CR(E) 90-3	22	865	1406	314	204	350	212	865	1406	314	308	350	242
CR 90-4-2	30	957	1567	407	315	400	320	-	-	-	-	-	-
CR 90-4	30	957	1567	407	315	400	320	-	-	-	-	-	-
CR 90-5-2	37	1049	1716	407	315	400	356	-	-	-	-	-	-
CR 90-5	37	1049	1716	407	315	400	356	-	-	-	-	-	-
CR 90-6-2	45	1141	1849	439	338	450	446	-	-	-	-	-	-
CR 90-6	45	1141	1849	439	338	450	446	-	-	-	-	-	-

CRN, CRNE 90

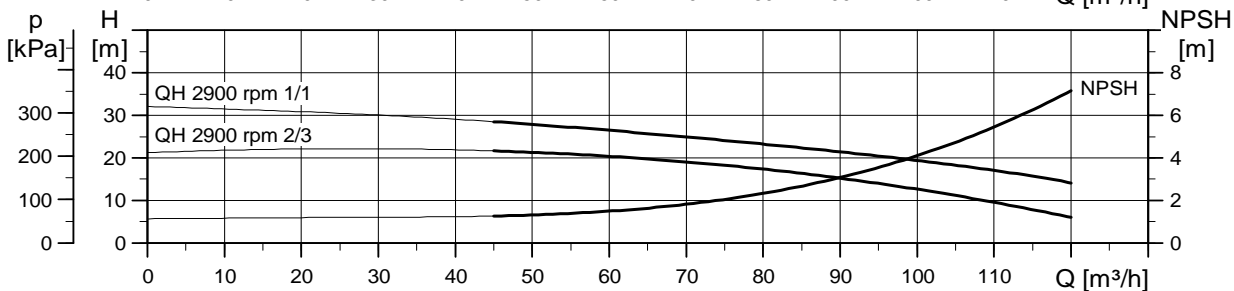
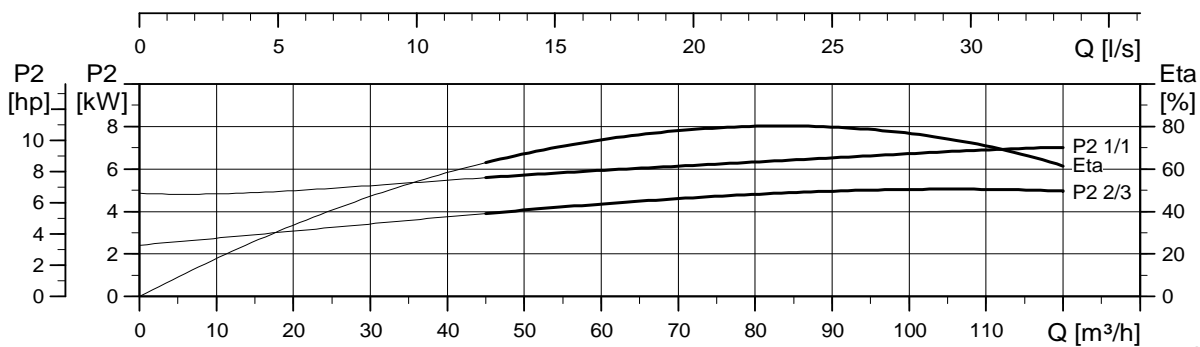
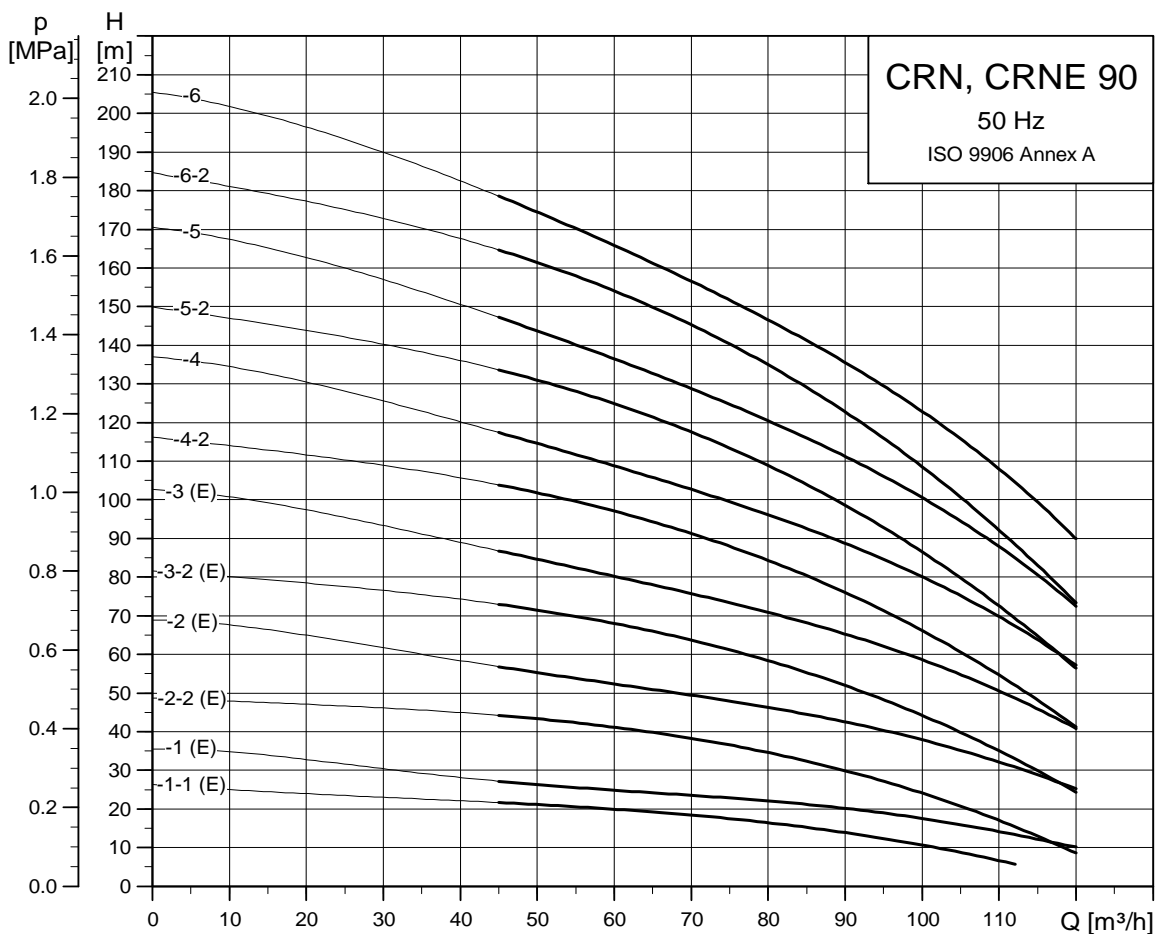

TM02 7309 3605

Dimensional sketch

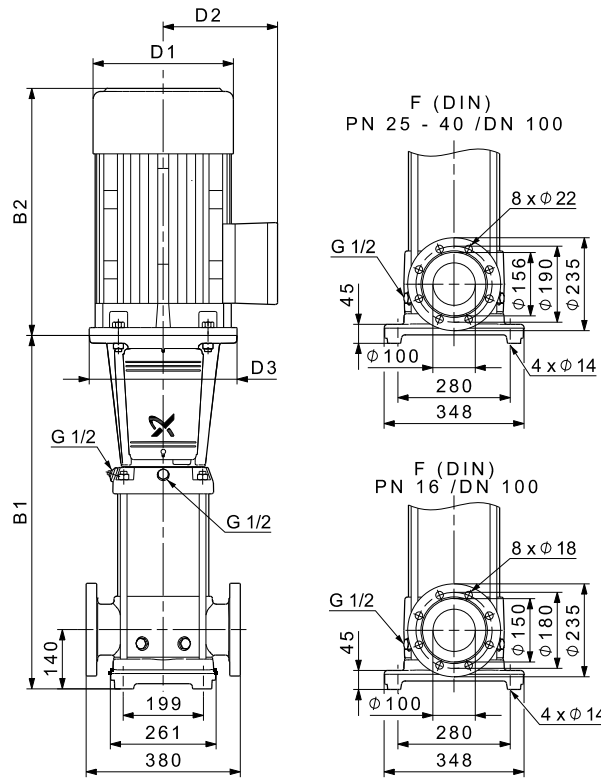

TM02 1570 4809

Dimensions and weights

Pump type	Motor P ₂ [kW]	CRN						CRNE							
		Dimension [mm]						Net weight [kg]	Dimension [mm]						Net weight [kg]
		B1	B1+B2	D1	D2	D3	B1		B1+B2	D1	D2	D3			
CRN(E) 90-1-1	5.5	571	962	220	134	300	109	571	962	220	188	300	115		
CRN(E) 90-1	7.5	571	950	260	159	300	121	571	962	260	213	300	118		
CRN(E) 90-2-2	11	773	1244	314	204	350	169	773	1244	314	308	350	199		
CRN(E) 90-2	15	773	1244	314	204	350	182	773	1244	314	308	350	214		
CRN(E) 90-3-2	18.5	865	1380	314	204	350	200	865	1380	314	308	350	231		
CRN(E) 90-3	22	865	1406	314	204	350	214	865	1406	314	308	350	244		
CRN 90-4-2	30	957	1567	407	315	400	321	-	-	-	-	-	-		
CRN 90-4	30	957	1567	407	315	400	321	-	-	-	-	-	-		
CRN 90-5-2	37	1049	1716	407	315	400	359	-	-	-	-	-	-		
CRN 90-5	37	1049	1716	407	315	400	359	-	-	-	-	-	-		
CRN 90-6-2	45	1141	1849	439	338	450	448	-	-	-	-	-	-		
CRN 90-6	45	1141	1849	439	338	450	448	-	-	-	-	-	-		

CR, CRE 120

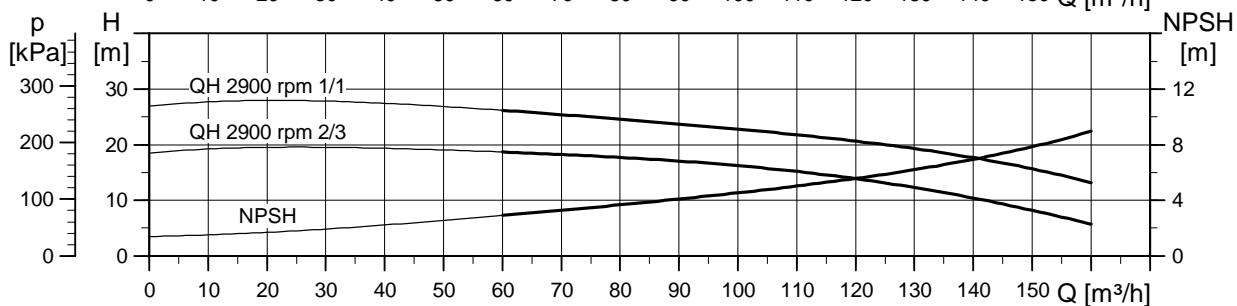
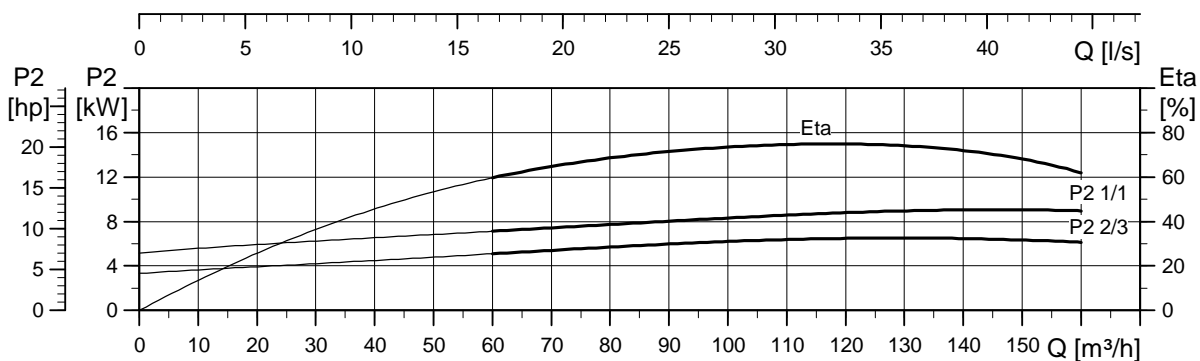
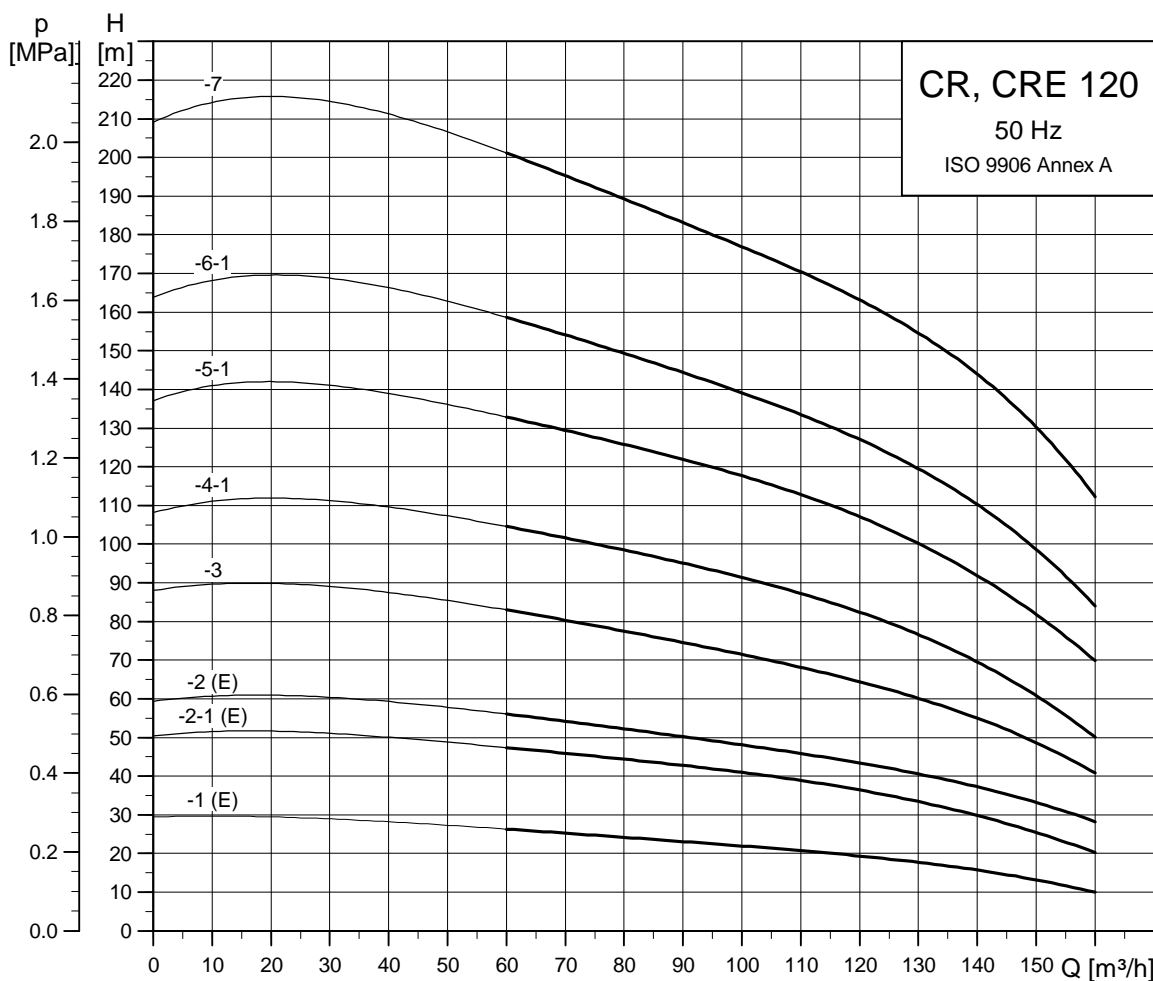

TM03 8743 4708

Dimensional sketch

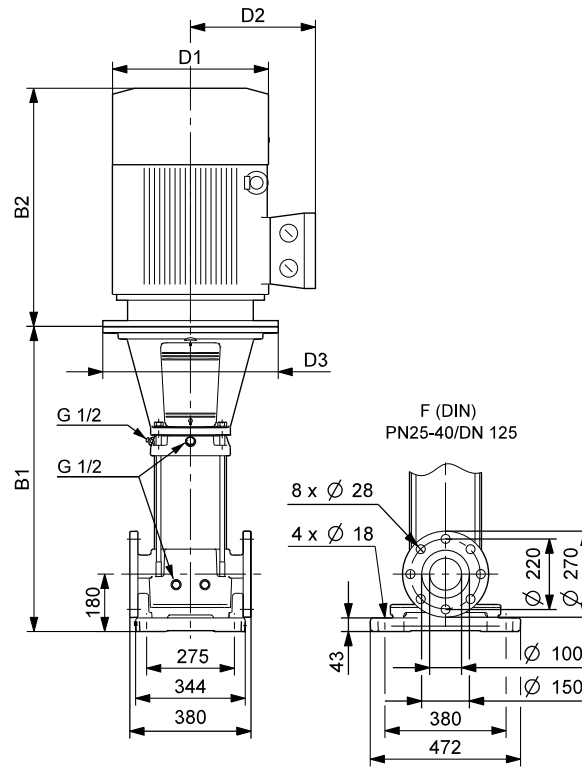

TM03 9704 4407

Dimensions and weights

Pump type	Motor P ₂ [kW]	CR					Net weight [kg]	CRE					Net weight [kg]
		Dimension [mm]						Dimension [mm]					
		B1	B1+B2	D1	D2	D3		B1	B1+B2	D1	D2	D3	
CR(E) 120-1	11	834	1305	314	204	350	191	834	1305	314	308	350	221
CR(E) 120-2-1	18.5	990	1505	314	204	350	227	990	1505	314	308	350	258
CR(E) 120-2	22	990	1531	314	204	350	241	990	1531	314	308	350	271
CR 120-3	30	1145	1755	407	315	400	353	-	-	-	-	-	-
CR 120-4-1	37	1301	1968	407	315	400	392	-	-	-	-	-	-
CR 120-5-1	45	1456	2164	439	338	450	487	-	-	-	-	-	-
CR 120-6-1	55	1642	2389	487	410	550	627	-	-	-	-	-	-
CR 120-7	75	1797	2617	540	433	550	741	-	-	-	-	-	-

CRN, CRNE 120

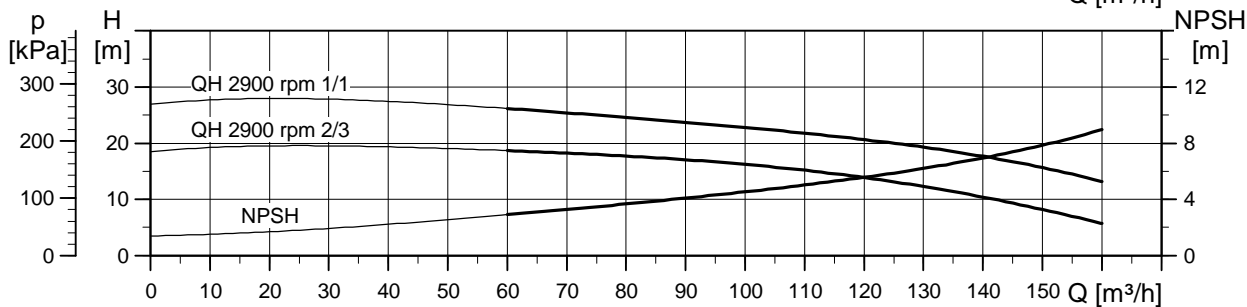
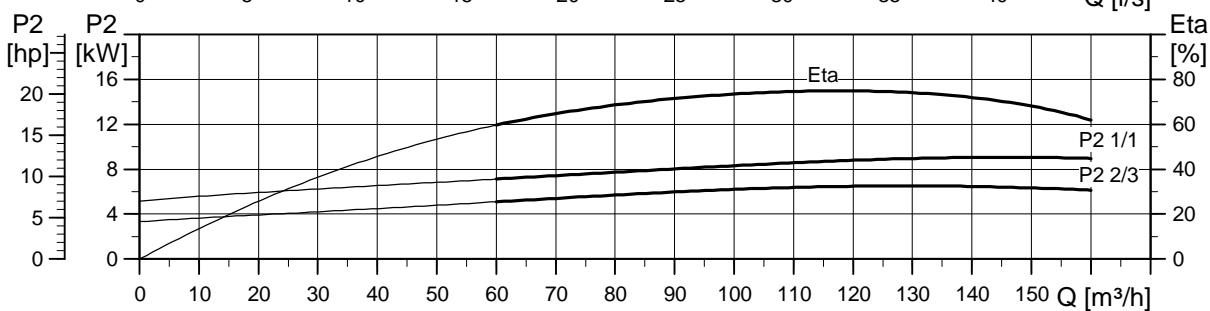
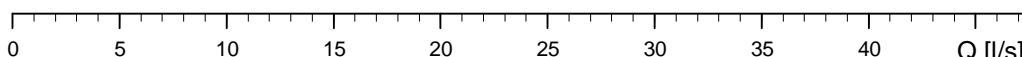
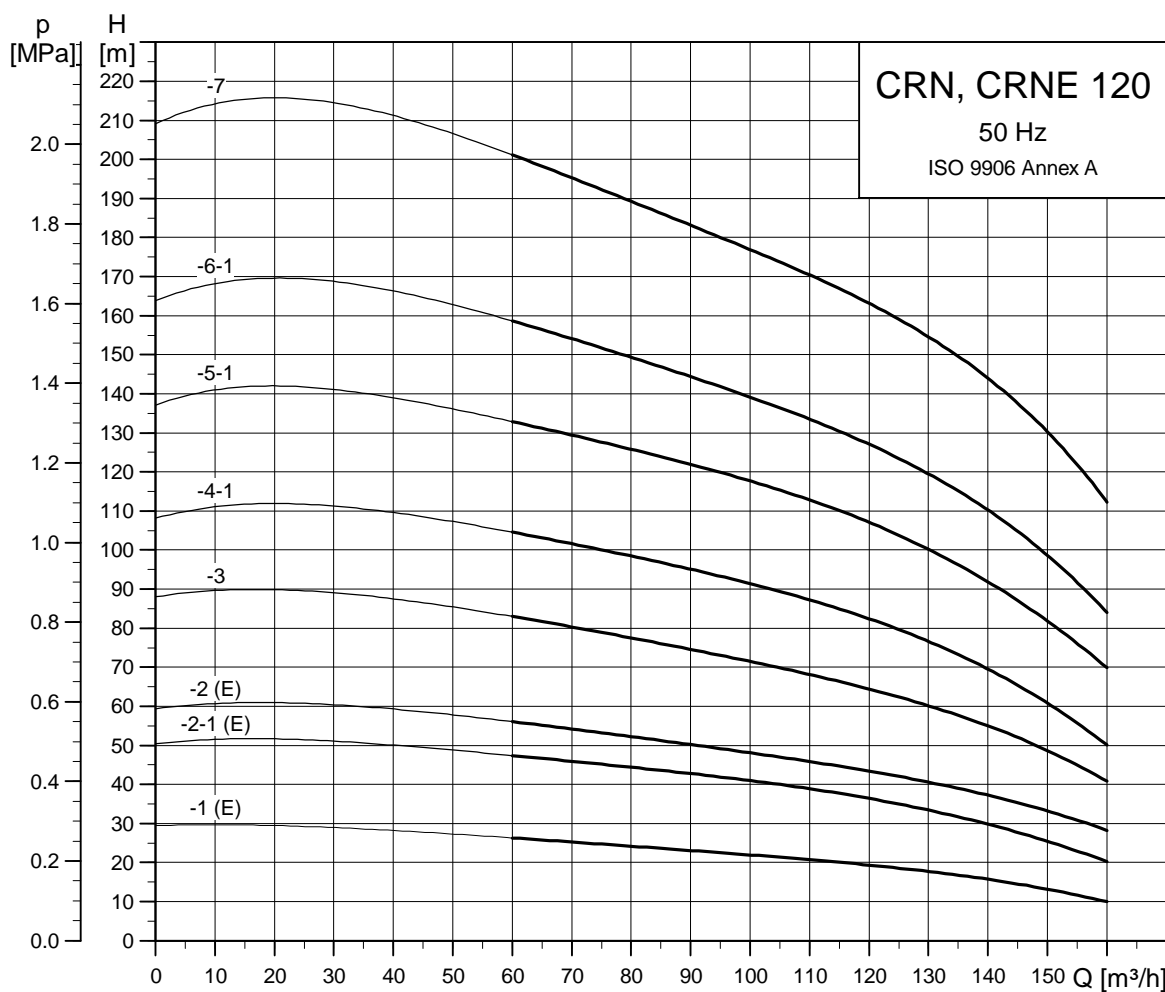

TM03 8744 4708

Dimensional sketch

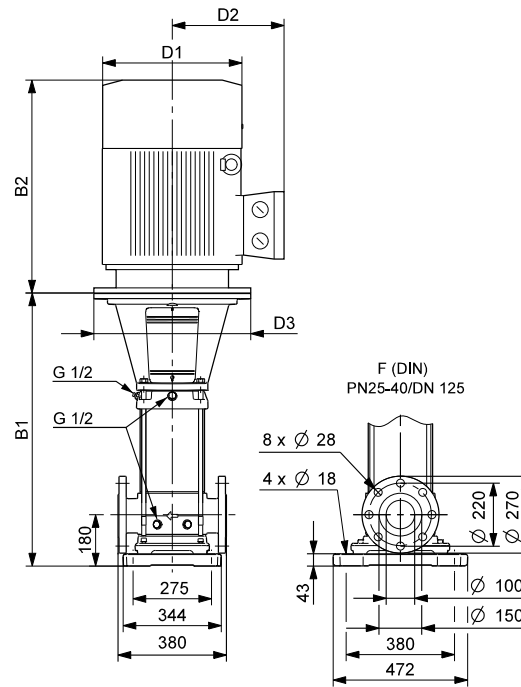

TM03 9705 2108

Dimensions and weights

Pump type	Motor P ₂ [kW]	CRN						CRNE					
		Dimension [mm]					Net weight [kg]	Dimension [mm]					Net weight [kg]
		B1	B1+B2	D1	D2	D3		B1	B1+B2	D1	D2	D3	
CRN(E) 120-1	11	834	1305	314	204	350	195	834	1305	314	308	350	225
CRN(E) 120-2-1	18.5	990	1505	314	204	350	231	990	1505	314	308	350	262
CRN(E) 120-2	22	990	1531	314	204	350	245	990	1531	314	308	350	275
CRN 120-3	30	1145	1755	407	315	400	357	-	-	-	-	-	-
CRN 120-4-1	37	1301	1968	407	315	400	397	-	-	-	-	-	-
CRN 120-5-1	45	1456	2164	439	338	450	491	-	-	-	-	-	-
CRN 120-6-1	55	1642	2389	487	410	550	631	-	-	-	-	-	-
CRN 120-7	75	1797	2617	540	433	550	755	-	-	-	-	-	-

CR, CRE 150

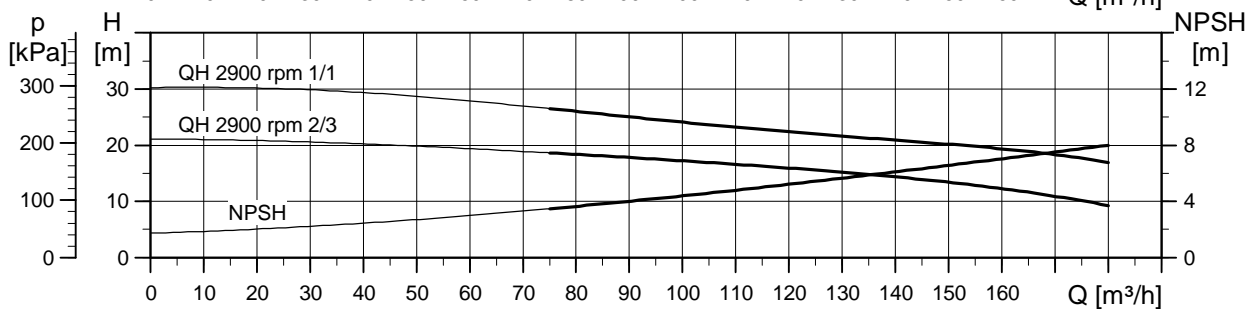
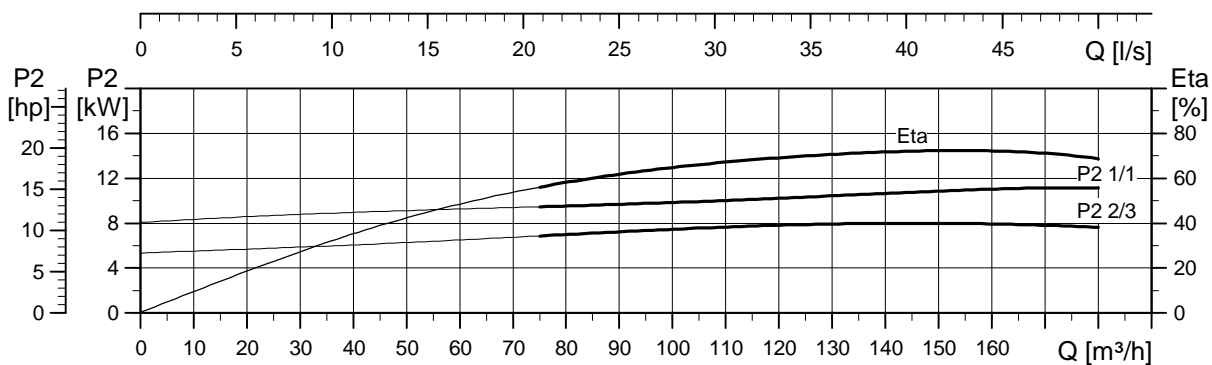
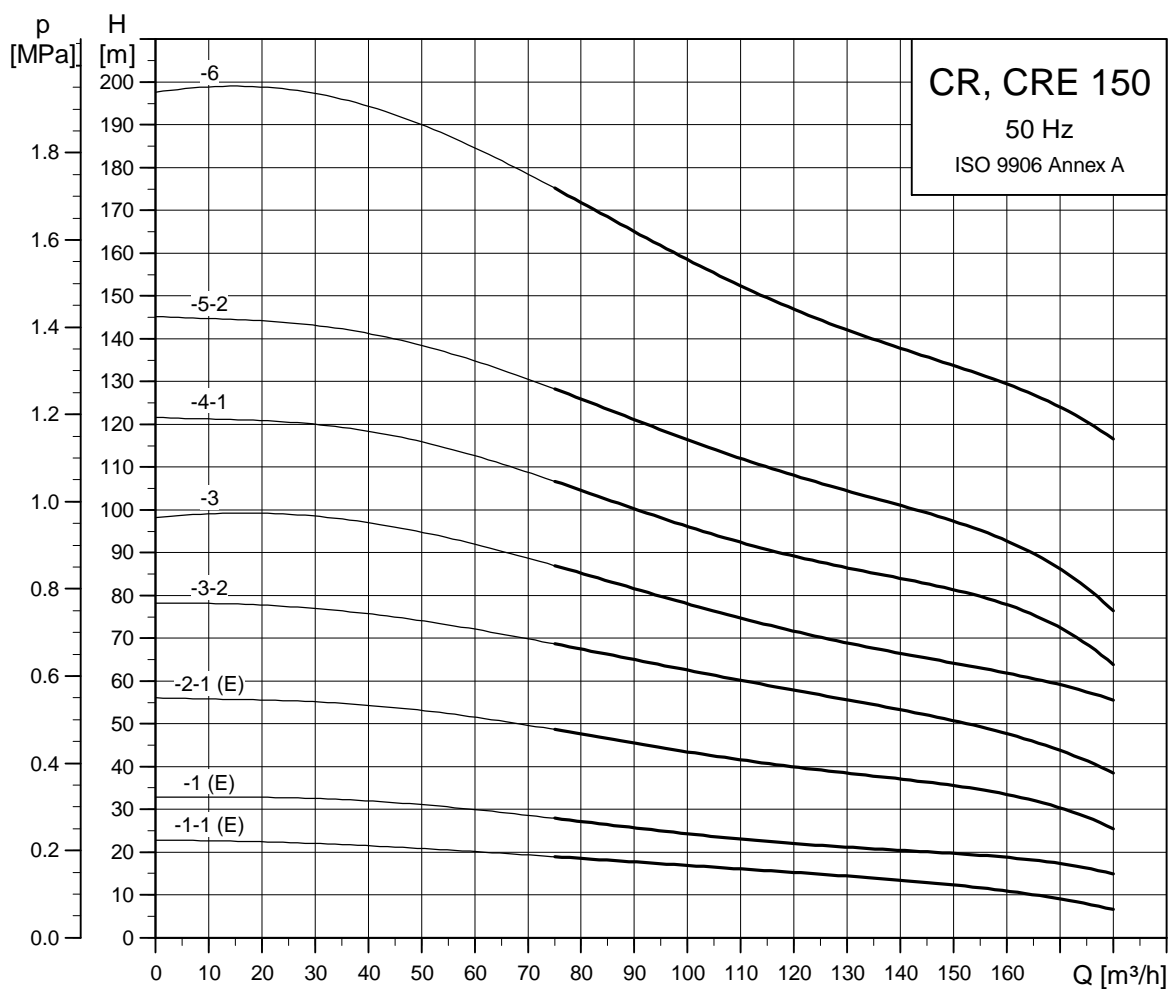

TM03 8745 4708

Dimensional sketch

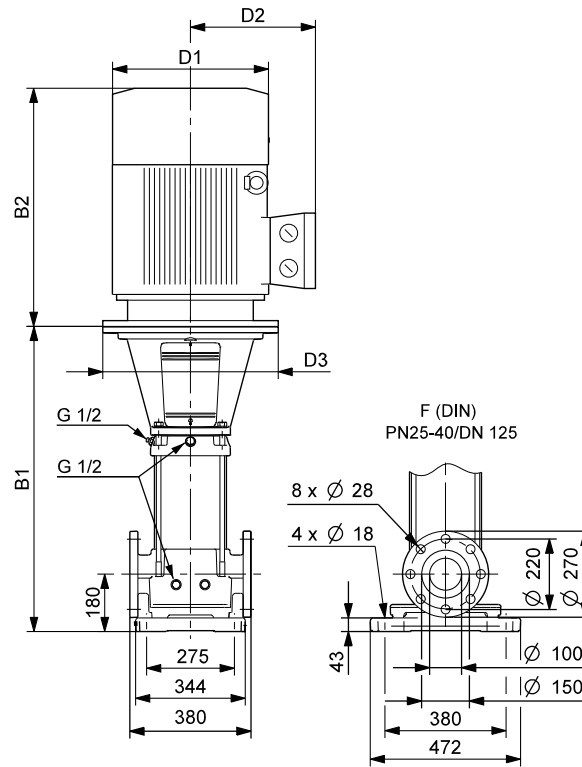

TM03 9704 4407

Dimensions and weights

Pump type	Motor P ₂ [kW]	CR						CRE					
		Dimension [mm]					Net weight [kg]	Dimension [mm]					Net weight [kg]
		B1	B1+B2	D1	D2	D3		B1	B1+B2	D1	D2	D3	
CR(E) 150-1-1	11	834	1305	314	204	350	191	834	1305	314	308	350	221
CR(E) 150-1	15	834	1305	314	204	350	204	834	1305	314	308	350	236
CR(E) 150-2-1	22	990	1531	314	204	350	241	990	1531	314	308	350	271
CR 150-3-2	30	1145	1755	407	315	400	353	-	-	-	-	-	-
CR 150-3	37	1145	1812	407	315	400	383	-	-	-	-	-	-
CR 150-4-1	45	1301	2009	439	338	450	477	-	-	-	-	-	-
CR 150-5-2	55	1486	2233	487	410	550	617	-	-	-	-	-	-
CR 150-6	75	1642	2462	540	433	550	733	-	-	-	-	-	-

CRN, CRNE 150

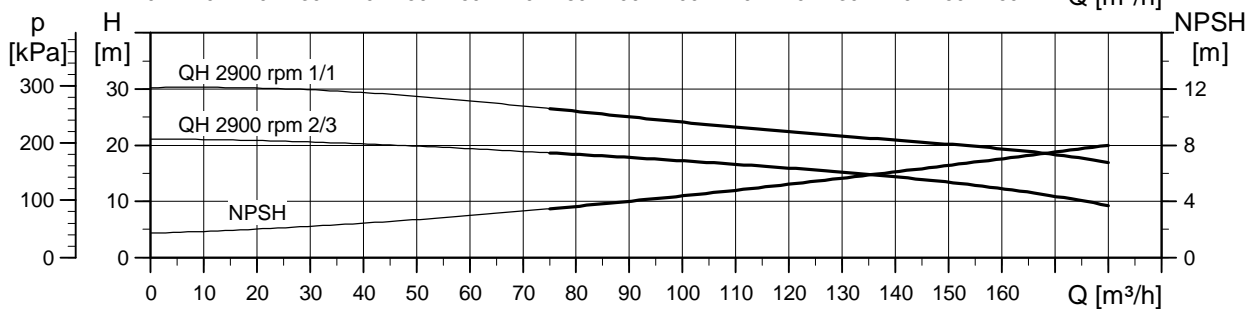
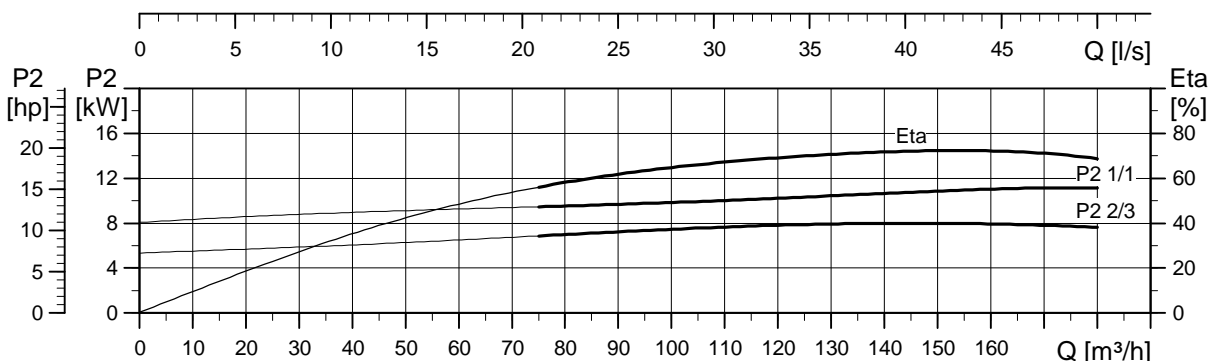
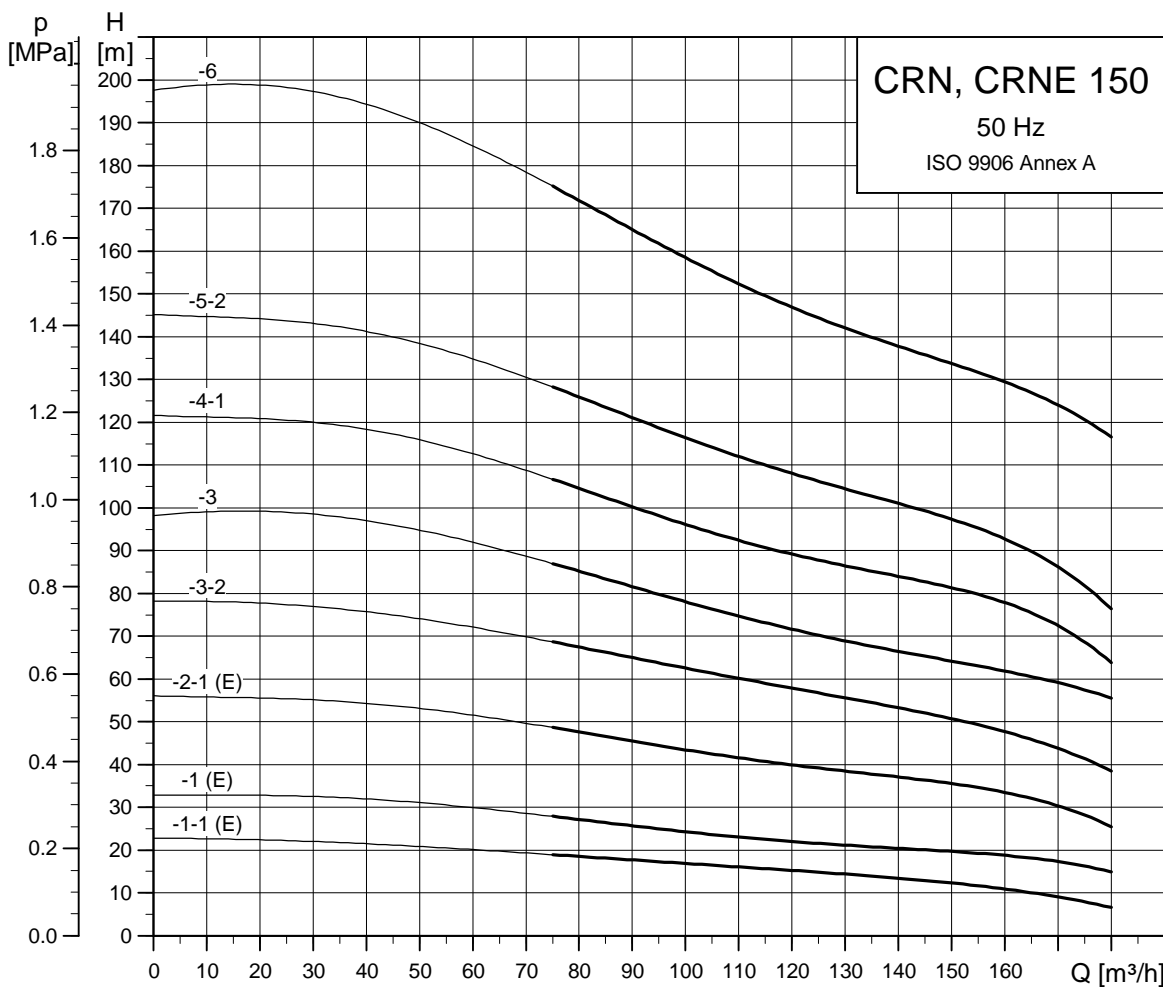

TM03 8746 4708

Dimensional sketch

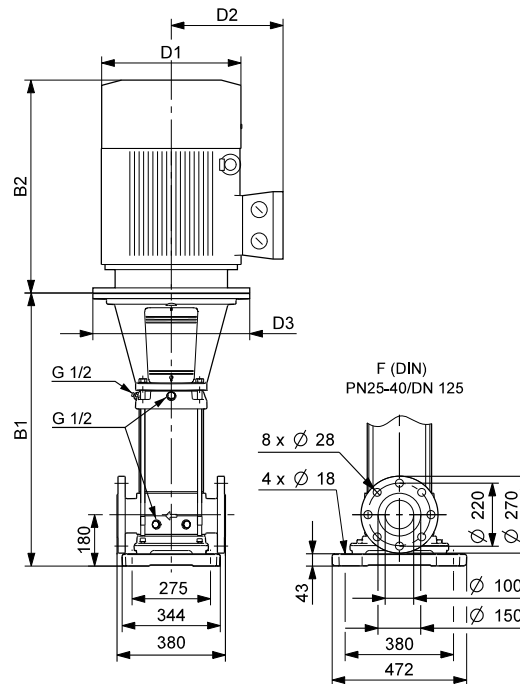



TM03 8889 2707

Dimensions and weights

Pump type	Motor P ₂ [kW]	CRN						CRNE					
		Dimension [mm]					Net weight [kg]	Dimension [mm]					Net weight [kg]
		B1	B1+B2	D1	D2	D3		B1	B1+B2	D1	D2	D3	
CRN(E) 150-1-1	11	834	1305	314	204	350	195	834	1305	314	308	350	225
CRN(E) 150-1	15	834	1305	314	204	350	208	834	1305	314	308	350	240
CRN(E) 150-2-1	22	990	1531	314	204	350	245	990	1531	314	308	350	275
CRN 150-3-2	30	1145	1755	407	315	400	357	-	-	-	-	-	-
CRN 150-3	37	1145	1812	407	315	400	387	-	-	-	-	-	-
CRN 150-4-1	45	1301	2009	439	338	450	481	-	-	-	-	-	-
CRN 150-5-2	55	1486	2233	487	410	550	621	-	-	-	-	-	-
CRN 150-6	75	1642	2462	540	433	550	736	-	-	-	-	-	-

7. Motor data

Standard motors for CR, CRI, CRN, 50 Hz

Motor P ₂ [kW]	Frame size	Standard voltage [V]	I _{1/1} [A]	Cos φ _{1/1}	Efficiency class	η [%]	I _{start} [%]	Speed [min ⁻¹]		
0.37	71	220-240Δ / 380-415Y	1.74 / 1.00	0.80 - 0.70	-	78.5	490-530	2850-2880	<p>MG</p>  <p>TM03 1711 2805</p>	
0.55	71	220-240Δ / 380-415Y	2.50 / 1.44	0.80 - 0.70	-	80.0	580-620	2830-2850		
0.75	80	220-240Δ / 380-415Y	3.30 / 1.90	0.81 - 0.71	IE3	80.7	580-620	2840-2870		
1.1	80	220-240Δ / 380-415Y	4.35 / 2.50	0.83 - 0.76	IE3	82.7	450-500	2840-2870		
1.5	90	220-240Δ / 380-415Y	5.45 / 3.15	0.87 - 0.82	IE3	84.2	850-930	2890-2910		
2.2	90	380-415Δ	4.45	0.89 - 0.87	IE3	85.9	850-950	2890-2910		
3.0	100	380-415Δ	6.30	0.87 - 0.82	IE3	87.1	840-920	2900-2920		
4.0	112	380-415Δ	7.90	0.87	IE3	88.1	1000-1110	2920-2940		
5.5	132	380-415Δ	11.0	0.87 - 0.82	IE3	89.2	1080-1180	2920-2940		
7.5	132	380-415Δ / 660-690Y	14.4 - 14.0 / 8.30 - 8.10	0.88 - 0.82	IE3	90.4	780-910	2910-2920		
11	160	380-415Δ / 660-690Y	20.8 - 19.8 / 12.0 - 11.8	0.88 - 0.84	IE3	91.2	660-780	2940-2950		
15	160	380-415Δ / 660-690Y	28.0 - 26.0 / 16.2 - 15.6	0.89 - 0.87	IE3	91.9	660-780	2930-2950		
18.5	160	380-415Δ / 660-690Y	34.5 - 32.5 / 20.0 - 18.8	0.89 - 0.85	IE3	92.4	830-980	2940-2950		
22	180	380-415Δ / 660-690Y	39.5 / 22.8	0.90	IE3	92.7	830-830	2950		
30	200	380-420Δ / 660-725Y	56.0 - 52.0 / 32.5 - 30.0	0.86	IE3	93.3	780-780	2955		<p>Siemens</p>  <p>TM03 1710 2805</p>
37	200	380-420Δ / 660-725Y	68.0 - 63.0 / 39.0 - 36.5	0.86	IE3	93.7	760-760	2950		
45	225	380-420Δ / 660-725Y	81.0 - 75.0 / 47.0 - 43.5	0.89	IE3	94.0	730-730	2960		
55	250	380-420Δ / 660-725Y	99.0 - 91.0 / 57.0 - 53.0	0.89	IE3	94.3	700-700	2975		
75	280	380-420Δ / 660-725Y	136 - 126 / 78.0 - 73.0	0.89	IE3	94.7	720-720	2975		

E-motors for CRE, CRIE, CRNE, 50 Hz

Motor P2 [kW]	Frame size	Number of phases	Standard voltage [V]	$I_{1/1}$ [A]	$\cos \Phi_{1/1}$	Efficiency class	η [%]
0.37	71	1	200-240	2.7 - 2.5	0.96	-	68.0
0.55	71	1	200-240	3.9 - 3.6	0.96	-	70.0
0.75	80	1	200-240	5.1 - 4.7	0.97	-	72.0
1.1	80	1	200-240	7.4 - 6.8	0.97	-	73.0
0.75*	90	3	380-480	2.1 - 1.8	0.80 - 0.70	IE3	77.0
1.1*	90	3	380-480	2.6 - 2.3	0.88 - 0.77	IE3	78.0
1.5	90	3	380-480	3.3 - 2.7	0.91 - 0.87	IE3	81.0
2.2	90	3	380-480	4.6 - 3.8	0.92 - 0.90	IE3	83.0
3.0	100	3	380-480	6.2 - 5.0	0.94 - 0.92	IE3	83.0
4.0	112	3	380-480	8.1 - 6.6	0.94 - 0.92	IE3	85.0
5.5	132	3	380-480	11.0 - 8.8	0.94 - 0.93	IE3	85.5
7.5	132	3	380-480	14.8 - 11.6	0.94 - 0.95	IE3	86.0
11	132	3	380-480	22.5 - 18.8	0.90 - 0.90	IE3	86.5
15	160	3	380-480	30.0 - 26.0	0.91 - 0.86	IE3	87.5
18.5	160	3	380-480	37.0 - 31.0	0.91 - 0.88	IE3	88.0
22	180	3	380-480	43.0 - 35.0	0.91 - 0.90	IE3	87.5

MGE



TM03 1712 2805

* Pumps are normally fitted with single-phase MGE motors. Previous dimension tables show pumps with single-phase MGE motors.

8. Pumped liquids

Thin, non-explosive liquids, not containing solid particles or fibres. The liquid must not chemically attack the pump materials.

When pumping liquids with a density and/or viscosity higher than that of water, use oversized motors, if required.

Whether a pump is suitable for a particular liquid depends on a number of factors of which the most important are the chloride content, pH value, temperature and content of chemicals, oils, etc.

Please note that aggressive liquids, such as sea water and some acids, may attack or dissolve the protective oxide film of the stainless steel and thus cause corrosion.

The CR(E), CRI(E), CRN(E) pumps are suitable for the following liquids:

CR(E), CRI(E)

CR(E), CRI(E) pumps are suitable for non-corrosive liquids.

Use CR(E), CRI(E) pumps for liquid transfer, circulation and pressure boosting of cold or hot clean water.

CRN(E)

CRN(E) pumps are suitable for industrial liquids.

Use CRN(E) pumps in systems where all parts in contact with the liquid must be made of high-grade stainless steel.

CRT(E)

For saline or chloride-containing liquids such as sea water or for oxidising agents such as hypochlorites, Grundfos offers CRT(E) pumps made of titanium.

See the separate data booklet on CRT(E) available on www.Grundfos.com (WebCAPS).

List of pumped liquids

A number of typical liquids are listed below.

Other pump versions may be applicable, but those stated in the list are considered to be the best choices.

The table is intended as a general guide only and cannot replace actual testing of the pumped liquids and pump materials under specific working conditions.

However, use the list with some caution. Factors such as those mentioned below may affect the chemical resistance of a specific pump version:

- concentration of the pumped liquid
- liquid temperature
- pressure.

Take safety precautions when pumping dangerous liquids.

Notes

D Often with additives.

E The density and/or viscosity differ from that/those of water. Take this factor into account when calculating motor output and pump performance.

F Pump selection depends on many factors. Contact Grundfos.

H Risk of crystallisation/precipitation in shaft seal.

1 Highly inflammable liquid.

2 Combustible liquid.

3 Insoluble in water.

4 Low self-ignition point.

Pumped liquid	Chemical formula	Note	Liquid concentration, liquid temperature	CR(E), CRI(E)	CRN(E)
Acetic acid	CH ₃ COOH	-	5 %, +20 °C	-	HQQE
Acetone	CH ₃ COCH ₃	1, F	100 %, +20 °C	-	HQQE
Alkaline degreasing agent		D, F	-	HQQE	-
Ammonium bicarbonate	NH ₄ HCO ₃	E	20 %, +30 °C	-	HQQE
Ammonium hydroxide	NH ₄ OH	-	20 %, +40 °C	HQQE	-
Aviation fuel		1, 3, 4, F	100 %, +20 °C	HQBV	-
Benzoic acid	C ₆ H ₅ COOH	H	0.5 %, +20 °C	-	HQQV
Boiler water		-	< +120 °C	HQQE	-
Calcareous water		F	+120 °C to +180 °C	-	-
Calcareous water		-	< +90 °C	HQQE	-
Calcium acetate (as coolant with inhibitor)	Ca(CH ₃ COO) ₂	D, E	30 %, +50 °C	HQQE	-
Calcium hydroxide	Ca (OH) ₂	E	Saturated solution, +50 °C	HQQE	-
Chloride-containing water		F	< +30 °C, max. 500 ppm	-	HQQE
Chromic acid	H ₂ CrO ₄	H	1 %, +20 °C	-	HQQV

Pumped liquid	Chemical formula	Note	Liquid concentration, liquid temperature	CR(E), CRI(E)	CRN(E)
Citric acid	$\text{HOC}(\text{CH}_2\text{CO}_2\text{H})_2\text{COOH}$	H	5 %, +40 °C	-	HQQE
Completely desalinated water (demineralised water)		-	+120 °C	-	HQQE
Condensate		-	+120 °C	HQQE	-
Copper sulphate	CuSO_4	E	10 %, +50 °C	-	HQQE
Corn oil		D, E, 3	100 %, +80 °C	HQQV	-
Diesel oil		2, 3, 4, F	100 %, +20 °C	HQBv	-
Domestic hot water (potable water)		-	< +120 °C	HQQE	-
Ethanol (ethyl alcohol)	$\text{C}_2\text{H}_5\text{OH}$	1, F	100 %, +20 °C	HQQE	-
Ethylene glycol	$\text{HOCH}_2\text{CH}_2\text{OH}$	D, E	50 %, +50 °C	HQQE	-
Formic acid	HCOOH	-	5 %, +20 °C	-	HQQE
Glycerine (glycerol)	$\text{OHCH}_2\text{CH}(\text{OH})\text{CH}_2\text{OH}$	D, E	50 %, +50 °C	HQQE	-
Hydraulic oil (mineral)		E, 2, 3	100 %, +100 °C	HQQV	-
Hydraulic oil (synthetic)		E, 2, 3	100 %, +100 °C	HQQV	-
Isopropyl alcohol	$\text{CH}_3\text{CHOHCH}_3$	1, F	100 %, +20 °C	HQQE	-
Lactic acid	$\text{CH}_3\text{CH}(\text{OH})\text{COOH}$	E, H	10 %, +20 °C	-	HQQV
Linoleic acid	$\text{C}_{17}\text{H}_{31}\text{COOH}$	E, 3	100 %, +20 °C	HQQV	-
Methanol (methyl alcohol)	CH_3OH	1, F	100 %, +20 °C	HQQE	-
Motor oil		E, 2, 3	100 %, +80 °C	HQQV	-
Naphthalene	C_{10}H_8	E, H	100 %, +80 °C	HQQV	-
Nitric acid	HNO_3	F	1 %, +20 °C	-	HQQE
Oil-containing water		-	< +100 °C	HQQV	-
Olive oil		D, E, 3	100 %, +80 °C	HQQV	-
Oxalic acid	$(\text{COOH})_2$	H	1 %, +20 °C	-	HQQE
Ozone-containing water	(O_3)	-	< +100 °C	-	HQQE
Peanut oil		D, E, 3	100 %, +80 °C	HQQV	-
Petrol		1, 3, 4, F	100 %, +20 °C	HQBv	-
Phosphoric acid	H_3PO_4	E	20 %, +20 °C	-	HQQE
Propanol	$\text{C}_3\text{H}_7\text{OH}$	1, F	100 %, +20 °C	HQQE	-
Propylene glycol	$\text{CH}_3\text{CH}(\text{OH})\text{CH}_2\text{OH}$	D, E	50 %, +90 °C	HQQE	-
Potassium carbonate	K_2CO_3	E	20 %, +50 °C	HQQE	-
Potassium formate (as coolant with inhibitor)	KOOCH	D, E	30 %, +50 °C	HQQE	-
Potassium hydroxide	KOH	E	20 %, +50 °C	-	HQQE
Potassium permanganate	KMnO_4	-	5 %, +20 °C	-	HQQE
Rape seed oil		D, E, 3	100 %, +80 °C	HQQV	-
Salicylic acid	$\text{C}_6\text{H}_4(\text{OH})\text{COOH}$	H	0.1 %, +20 °C	-	HQQE
Silicone oil		E, 3	100 %	HQQV	-
Sodium bicarbonate	NaHCO_3	E	10 %, +60 °C	-	HQQE
Sodium chloride (as coolant)	NaCl	D, E	30 %, < +5 °C, pH > 8	HQQE	-
Sodium hydroxide	NaOH	E	20 %, +50 °C	-	HQQE
Sodium hypochlorite	NaOCl	F	0.1 %, +20 °C	-	HQQV
Sodium nitrate	NaNO_3	E	10 %, +60 °C	-	HQQE
Sodium phosphate	Na_3PO_4	E, H	10 %, +60 °C	-	HQQE
Sodium sulphate	Na_2SO_4	E, H	10 %, +60 °C	-	HQQE
Softened water		-	< +120 °C	-	HQQE
Soya oil		D, E, 3	100 %, +80 °C	HQQV	-
Sulphuric acid	H_2SO_4	F	1 %, +20 °C	-	HQQV
Sulphurous acid	H_2SO_3	-	1 %, +20 °C	-	HQQE
Unsalted swimming-pool water		-	Approx. 2 ppm free chlorine (Cl_2)	HQQE	-

9. Accessories

Pipework connection

Various sets of counter flanges and couplings are available for pipework connection.

Adapter kit

DN 150 flanges are available for CR, CRN 120 and 150 pumps. To use DN 150 flanges, two adapter kits must be ordered per pump.

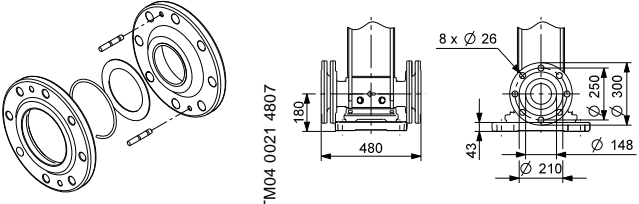
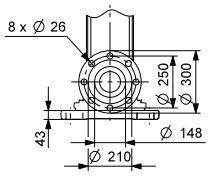
Adapter kit	Pump type	Pipe connection	Number of flange kits required	Product number
 TM04 0021 4807	CR 120 CR 150	150 mm, nominal	2	96638169
 TM04 0020 4807	CRN 120 CRN 150	150 mm, nominal	2	96638180

Counter flanges for CR(E)

A counter flange set consists of one counter flange, one gasket, bolts and nuts.

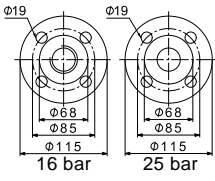
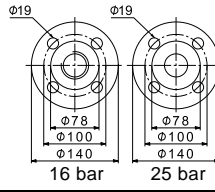
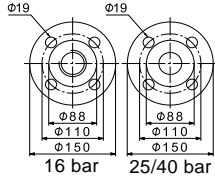
Counter flange	Pump type	Description	Rated pressure	Pipework connection	Product number
 16 bar 25 bar	TM05 0998 2011 CR 1s CR(E) 1 CR(E) 3 CR(E) 5	Threaded	16 bar, EN 1092-2	Rp 1	409901
		For welding	25 bar, EN 1092-2	25 mm, nominal	409902
 16 bar 25 bar	TM05 1003 2011 CR 1s CR(E) 1 CR(E) 3 CR(E) 5	Threaded	16 bar, EN 1092-2	Rp 1 1/4	419901
		For welding	25 bar, EN 1092-2	32 mm, nominal	419902
 16 bar 25/40 bar	TM05 1002 2011 CR(E) 10	Threaded	16 bar, EN 1092-2	Rp 1 1/2	429902
		Threaded	16 bar, EN 1092-2	Rp 2	429904
		For welding	25 bar, EN 1092-2	40 mm, nominal	429901
		For welding	40 bar, special flange	50 mm, nominal	429903

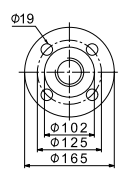
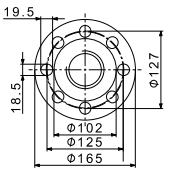
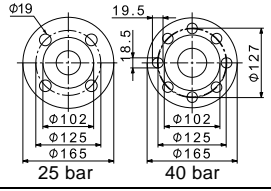
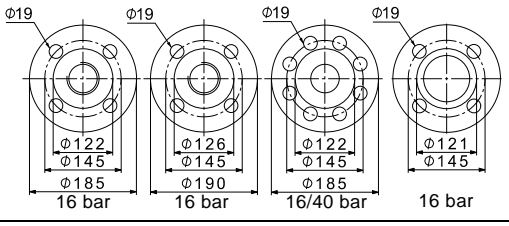
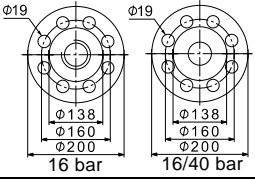
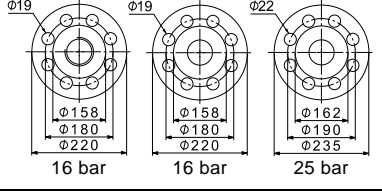
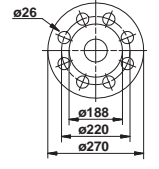
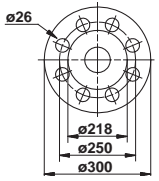
Counter flange	Pump type	Description	Rated pressure	Pipework connection	Product number	
	TM05 0999 2011	Threaded	16 bar, EN 1092-2	Rp 2	339903	
		Threaded	16 bar, special flange	Rp 2 1/2	339904	
	TM05 1005 2011	CR(E) 15 CR(E) 20	Threaded	16 bar, special flange	Rp 2 1/2*	96509578
	TM05 1000 2011	For welding	25 bar, EN 1092-2	50 mm, nominal	339901	
		For welding	40 bar, special flange	65 mm, nominal	339902	
	TM05 0997 2011	CR(E) 32	Threaded	16 bar, EN 1092-2	Rp 2 1/2	349902
			Threaded	16 bar, special flange	Rp 3	349901
			For welding	16 bar, EN 1092-2	65 mm, nominal	349904
			For welding	40 bar, DIN 2635	65 mm, nominal	349905
			For welding	16 bar, special flange	80 mm, nominal	349903
	TM05 0996 2011	CR(E) 45	Threaded	16 bar	Rp 3	350540
			For welding	16 bar	80 mm, nominal	350541
			For welding	40 bar	80 mm, nominal	350542
	TM05 0995 2011	CR(E) 64 CR(E) 90	Threaded	16 bar, EN 1092-2	Rp 4	369901
			For welding	16 bar, EN 1092-2	100 mm, nominal	369902
			For welding	25 bar, EN 1092-2	100 mm, nominal	369905
	TM03 8892 2707	CR(E) 120	For welding	40 bar, EN 1092-2	125 mm, nominal	96750475
	TM03 8891 2707	CR(E) 150	For welding	40 bar, EN 1092-2	150 mm, nominal	96750476

* Flange with 20 mm higher collar. With this collar, the installation dimensions of a CR 20 will be identical to those of a CR 32. If a CR 32 is replaced with a CR 20, the base must be raised by 15 mm.

Counter flanges for CRN(E)

Counter flanges for CRN(E) pumps are made of stainless steel to EN 1.4401 (AISI 316).

A counter flange set consists of one counter flange, one gasket, bolts and nuts.

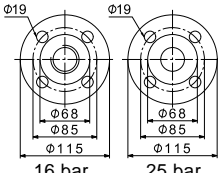
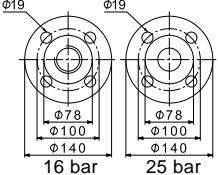
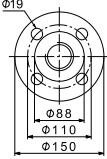
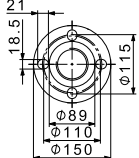
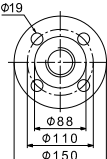
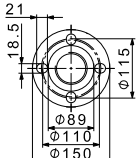
Counter flange	Pump type	Description	Rated pressure	Pipework connection	Product number
	TM05 0998 2011 CRI(E), CRN(E) 1s, 1, 3, 5	Threaded	16 bar, EN 1092-2	Rp 1	405284
		For welding	25 bar, EN 1092-2	25 mm, nominal	405285
	TM05 1003 2011 CRI(E), CRN(E) 1s, 1, 3, 5	Threaded	16 bar, EN 1092-2	Rp 1 1/4	415304
		For welding	25 bar, EN 1092-2	32 mm, nominal	415305
	TM05 1001 2011	Threaded	16 bar, EN 1092-2	Rp 1 1/2	425245
	TM05 1006 2011	Threaded	16 bar, EN 1092-2	Rp 2	96509570
	TM05 1001 2011	For welding	25 bar, EN 1092-2	40 mm, nominal	425246
	TM05 1006 2011	For welding	25 bar, special flange	50 mm, nominal	96509571

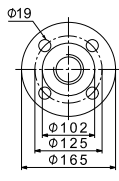
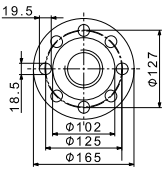
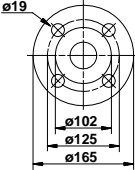
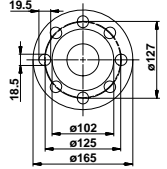
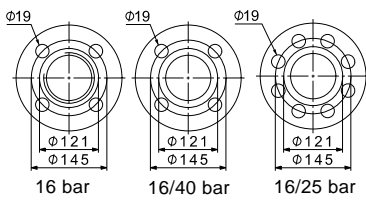
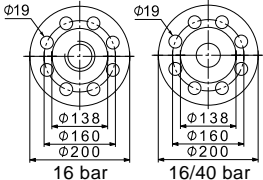
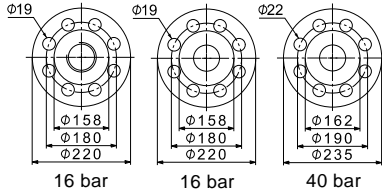
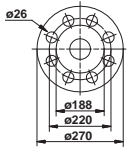
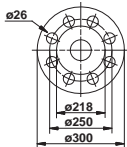
Counter flange	Pump type	Description	Rated pressure	Pipework connection	Product number
	TM05 0999 2011	Threaded	16 bar, EN 1092-2	Rp 2	335254
	TM05 1005 2011	Threaded	16 bar, special flange	Rp 2 1/2	96509575
		Threaded	16 bar, special flange	Rp 2 1/2*	96509579
	TM03 0402 2011	For welding	25 bar, EN 1092-2	50 mm, nominal	335255
	TM00 7203 2803	For welding	25 bar, special flange	65 mm, nominal	96509573
	TM05 0994 2011	Threaded	16 bar	Rp 2 1/2	349910
16 bar		Threaded	16 bar, special flange	Rp 3	349911
16/40 bar		For welding	16 bar	65 mm, nominal	349906
16/25 bar		For welding	40 bar	65 mm, nominal	349908
		For welding	16 bar, special flange	80 mm, nominal	349907
		For welding	25 bar, special flange	80 mm, nominal	349909
	TM05 0996 2011	Threaded	16 bar	Rp 3	350543
16 bar		For welding	16 bar	80 mm, nominal	350544
16/40 bar		For welding	40 bar	80 mm, nominal	350545
	TM05 0995 2011	Threaded	16 bar	Rp 4	369904
16 bar		For welding	16 bar	100 mm, nominal	369903
16 bar		For welding	40 bar	100 mm, nominal	369906
	TM03 8892 2707	For welding	40 bar, EN 1092-2	125 mm, nominal	96750477
	TM03 8891 2707	For welding	40 bar, EN 1092-2	150 mm, nominal	96750478

* Flange with 20 mm higher collar. With this collar, the installation dimensions of a CR 20 will be identical to those of a CR 32. If a CR 32 is replaced with a CR 20, the base must be raised by 15 mm.

PJE couplings for CRN(E)

Materials in contact with the pumped liquid are made of stainless steel to EN 1.4401 (AISI 316) and rubber.

A PJE coupling set consists of two coupling halves (Victaulic, type 77), one gasket, one pipe stud (for welding or threaded), bolts and nuts.

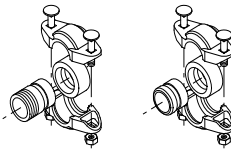
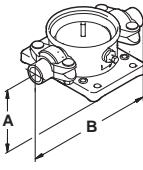
Coupling	Pump type	Pipe stub	PN	A	B	Pipework connection	Rubber parts	Number of coupling sets required	Product number	
	TM00 3808 1094 CRI(E) CRN(E) 1, 3, 5	Threaded	80	50	320	R 1 1/4	EPDM	2	419911	
								FKM	2	419905
		For welding	80	50	280	DN 32		EPDM	2	419912
								FKM	2	419904
	TM03 8890 2707 CRI(E) CRN(E) 10, 15, 20	Threaded	70	80	377	R 2	EPDM	2	339911	
								FKM	2	339918
		For welding	70	80	371	DN 50		EPDM	2	339910
								FKM	2	339917

FlexiClamp base connections

All sets comprise the necessary number of bolts and nuts as well as a gasket/O-ring.

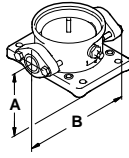
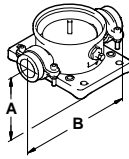
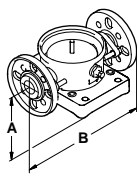
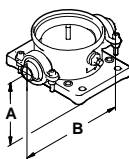
Base connection	Pump type	Connection	Pipework connection	PN	A	B	Rubber parts	Number of coupling sets required	Product number
	TM02 7368 3303 CRI(E) CRN(E) 1, 3, 5	Oval (cast iron)	Rp 1	16	50	210	Klingsil	1	96449748
			Rp 1 1/4				Klingsil	1	96449749
		Oval (stainless steel)	Rp 1	Klingsil	2	96449746			
			Rp 1 1/4	Klingsil	2	96449747			
	TM02 7369 3303 CRI(E) CRN(E) 1, 3, 5	Union	G 2	25	50	228	EPDM	2	96449743
							FKM	2	96449744
	TM02 7370 3303 CRI(E) CRN(E) 1, 3, 5	DIN (stainless steel)	DN 25	16	75	250	EPDM	2	96449745
			DN 32				FKM	2	96449900
	TM02 7371 3303 CRI(E) CRN(E) 1, 3, 5	Clamp, threaded pipe stub	Rp 1	25	50	208	EPDM	2	405280
							FKM	2	405281
			Rp 1 1/4				EPDM	2	415296
							FKM	2	415297
			1" NPT				EPDM	2	405291
							FKM	2	405292
			1 1/4" NPT				EPDM	2	415311
							FKM	2	415312
Clamp, pipe stub for welding	28.5	EPDM	2	405282					
		FKM	2	405283					
	37.2	EPDM	2	415300					
		FKM	2	415301					

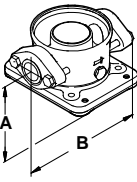
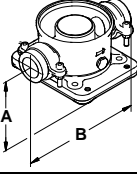
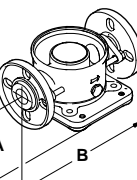
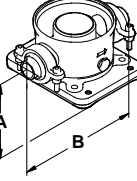
Base connection	Pump type	Connection	Pipework connection	PN	A	B	Rubber parts	Number of coupling sets required	Product number	
	CRI(E) 10 CRN(E) 10 TM02 7372 3303	Oval (cast iron)	Rp 1 1/4	16	80	260	Klingsil	2	96498775	
			Rp 1 1/2				Klingsil	2	96498727	
			Rp 2				Klingsil	2	96498836	
			Rp 1 1/4				Klingsil	2	96498776	
			Rp 1 1/2				Klingsil	2	96498728	
			Rp 2				Klingsil	2	96498835	
	CRI(E) 10 CRN(E) 10 TM02 7374 3303	Union	G 2 3/4	25	80	288	EPDM	2	96500275	
							FKM	2	96500276	
	CRI(E) 10 CRN(E) 10 TM02 7373 3303	FGJ (cast iron)	DN 40	16	80	316	EPDM	2	96498840	
							FKM	2	96500119	
							FGJ (stainless steel)	EPDM	2	96500263
							FKM	2	96500264	
							FGJ (cast iron)	EPDM	2	96500265
							FKM	2	96500266	
	CRI(E) 10 CRN(E) 10 TM02 7375 3303	Clamp, threaded pipe stub	Rp 1 1/2	25	80	346	EPDM	2	425238	
			FKM				2	425239		
			Rp 2				EPDM	2	335241	
			FKM				2	335242		
			Rp 2 1/2				EPDM	2	96508600	
			FKM				2	96508601		
			48.3 (DN 40)				EPDM	2	425242	
			FKM				2	425243		
			60.3 (DN 50)				EPDM	2	335251	
			FKM				2	335252		

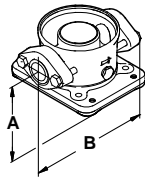
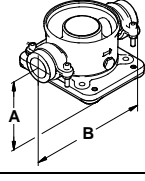
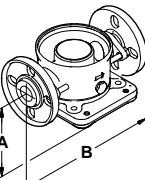
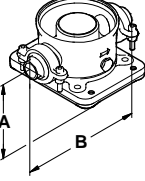
Base connection	Pump type	Connection	Pipework connection	PN	A	B	Rubber parts	Number of coupling sets required	Product number		
	CRI(E) 15, 20 CRN(E) 15, 20	Oval (cast iron)	Rp 1 1/4	10	90	260	Klingersil	2	96498775		
			Rp 1 1/2				Klingersil	2	96498727		
			Rp 2				Klingersil	2	96498836		
			Rp 1 1/4				Klingersil	2	96498776		
			Rp 1 1/2				Klingersil	2	96498728		
			Rp 2				Klingersil	2	96498835		
	CRI(E) 15, 20 CRN(E) 15, 20	Union	G 2 3/4	25	90	288	EPDM	2	96500275		
							FKM	2	96500276		
	CRI(E) 15, 20 CRN(E) 15, 20	FGJ (cast iron)	DN 40	10	90	334	EPDM	2	96498840		
							FKM	2	96500119		
							FGJ (stainless steel)	EPDM	2	96500263	
							FKM	2	96500264		
							FGJ (cast iron)	EPDM	2	96500265	
							FKM	2	96500266		
	CRI(E) 15, 20 CRN(E) 15, 20	FGJ (stainless steel)	DN 50	25	90	346	EPDM	2	96500267		
							FKM	2	96500269		
							Clamp, threaded pipe stub	Rp 1 1/2	EPDM	2	425238
								Rp 2	FKM	2	425239
								Rp 2 1/2	EPDM	2	335241
								Rp 2 1/2	FKM	2	335242
Rp 2 1/2	EPDM	2	96508600								
Rp 2 1/2	FKM	2	96508601								
Clamp, pipe stub for welding	48.3 (DN 40)	EPDM	2	425242							
	48.3 (DN 40)	FKM	2	425243							
	60.3 (DN 50)	EPDM	2	335251							
	60.3 (DN 50)	FKM	2	335252							

Potentiometer for CRE, CRIE, CRNE

The potentiometer is for setpoint setting and start/stop of the CRE, CRIE, CRNE pump.

Product	Product number
External potentiometer with cabinet for wall mounting	625468

G10-LON interface for CRE, CRIE, CRNE

Use the G10-LON interface in connection with data transmission between a Locally Operating Network (LON) and electronically controlled Grundfos pumps applying the Grundfos GENIbus protocol.

Product	Product number
G10-LON interface	00605726

LiqTec for CR(E), CRI(E) and CRN(E)

The LiqTec dry-running protection device protects the pump and process against dry running and temperatures exceeding 130 °C ± 5 °C. Connected to the motor PTC sensor, the LiqTec also monitors the motor temperature.

LiqTec is prepared for DIN rail mounting in control cabinet.

Enclosure class: IPX0.

R100 remote control

Use the R100 for wireless communication with the CRE, CRIE, CRNE pump. The communication takes place by means of infrared light.

Product	Product number
R100	625333

EMC filter for CRE, CRIE, CRNE

The EMC filter is required when 11 to 22 kW E-pumps are installed in residential areas.

Product	Product number
EMC filter (11 kW)	
EMC filter (15 kW)	
EMC filter (18.5 kW)	96478309
EMC filter (22 kW)	

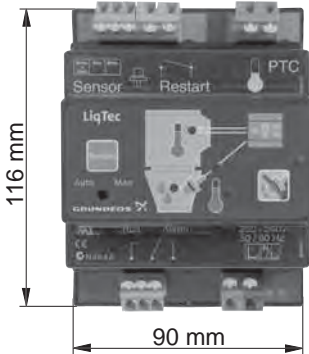
Dry-running protection	Pump type	Voltage [V]	LiqTec	Sensor, 1/2"	Cable, 5 m	Extension cable, 15 m	Product number
 <p>116 mm</p> <p>90 mm</p> <p>TM03 2108 3705</p>	<p>CR(E) CRI(E) CRN(E)</p>	200-240	•	•	•	-	96556429
		80-130	•	•	•	-	96556430
		-	-	-	-	-	•

Sensors for CRE, CRIE, CRNE

Accessory	Type	Supplier	Measuring range	Product number
Flowmeter	SITRANS FM MAGFLO MAG 5100 W	Siemens	1-5 m ³ (DN 25)	ID8285
Flowmeter	SITRANS FM MAGFLO MAG 5100 W	Siemens	3-10 m ³ (DN 40)	ID8286
Flowmeter	SITRANS FM MAGFLO MAG 5100 W	Siemens	6-30 m ³ (DN 65)	ID8287
Flowmeter	SITRANS FM MAGFLO MAG 5100 W	Siemens	20-75 m ³ (DN 100)	ID8288
Temperature sensor	TTA (0) 25	Carlo Gavazzi	0 °C to +25 °C	96432591
Temperature sensor	TTA (-25) 25	Carlo Gavazzi	-25 °C to +25 °C	96430194
Temperature sensor	TTA (50) 100	Carlo Gavazzi	+50 °C to +100 °C	96432592
Temperature sensor	TTA (0) 150	Carlo Gavazzi	0 °C to +150 °C	96430195
Accessory for temperature sensor. All with 1/2 RG connection	Protecting tube ∅9 x 50 mm	Carlo Gavazzi		96430201
	Protecting tube ∅9 x 100 mm	Carlo Gavazzi		96430202
	Cutting ring bush	Carlo Gavazzi		96430203
Temperature sensor, ambient temperature	WR 52	tmg (DK: Plesner)	-50 °C to +50 °C	ID8295
Differential-temperature sensor	ETSD	Honsberg	0 °C to +20 °C	96409362
Differential-temperature sensor	ETSD	Honsberg	0 °C to +50 °C	96409363

Note: All sensors have 4-20 mA signal output.

Danfoss pressure sensor kits for CRE, CRIE, CRNE 1, 3, 5, 10, 15, 20, 32, 45, 64, 90, 120, and 150

The kit comprises:	Temperature range	Pressure range [bar]	Product number
<ul style="list-style-type: none"> Danfoss pressure transmitter, type MBS 3000, with 2 m screened cable Connection: G 1/2 A (DIN 16288 - B6kt) 5 cable clips (black) Instruction manual PT (400212) 	-40 °C to +85 °C	0-4	96428014
		0-6	96428015
		0-10	96428016
		0-16	96428017
		0-25	96428018

DPI differential pressure sensor kit

The kit comprises:	Pressure range [bar]	Product number
<ul style="list-style-type: none"> 1 sensor incl. 0.9 m screened cable (7/16" connections) 1 original DPI bracket (for wall mounting) 1 Grundfos bracket (for mounting on motor) 2 M4 screws for mounting of sensor on bracket 1 M6 self-cutting screw for mounting on MGE 90/100 1 M8 self-cutting screw for mounting on MGE 112/132 3 capillary tubes (short/long) 2 fittings (1/4" - 7/16") 5 cable clips (black) Installation and operating instructions (480675) Service kit instructions. 	0 - 0.6	96611522
	0 - 1.0	96611523
	0 - 1.6	96611524
	0 - 2.5	96611525
	0 - 4.0	96611526
	0 - 6.0	96611527
	0-10	96611550

10. Variants

Lists of variants

The variants are available on request.

Although the Grundfos CR(E), CRI(E), CRN(E) product range offers a number of pumps for different applications, customers require specific pump solutions to satisfy their demands.

See the following documents:

- Grundfos CR "Custom-built pumps" catalogue
- Grundfos "CR, CRN high pressure" data booklet.

Below please find the range of options available for customising the CR(E) pumps to meet the customers' demands.

Contact Grundfos for further information or for requests other than the ones mentioned below.

Motors

Variant	Description
ATEX-approved motor	For operation in hazardous atmospheres, explosion-proof or dust-ignition-proof motors may be required.
Motor with anti-condensation heating unit	For operation in humid environments motors with built-in anti-condensation heating unit may be required.
Motor with thermal protection	Grundfos offers motors with built-in bimetallic thermal switches or temperature-controlled PTC sensors (thermistors) incorporated in the motor windings.
Oversize motor	Ambient temperatures above 40 °C or installation at altitudes of more than 1000 metres above sea level require the use of an oversize motor (i.e. derating).
4-pole motor	Grundfos offers 4-pole standard motors.

Shaft seals

Variant	Description
Shaft seal with FFKM O-ring	Shaft seals with FFKM or FXM O-ring are recommended for applications where the pumped liquid may damage the standard O-ring material.
Seal with flush, quench seal	Recommended for applications involving crystallising, hardening or sticky liquids.
Air-cooled shaft seal system	Recommended for applications involving extremely high temperatures. No conventional mechanical shaft seal can withstand liquid temperatures of up to 180 °C for any length of time. For such applications, Grundfos' unique air-cooled shaft seal system is recommended. In order to ensure a low liquid temperature around the standard shaft seal, the pump is fitted with a special air-cooled shaft seal chamber. No separate cooling is required.
Double seal with pressure chamber	Recommended for applications involving poisonous or explosive liquids. Protects the surrounding environment and the people working in the vicinity of the pump. Consists of two seals mounted in a "back-to-back" arrangement inside a separate pressure seal chamber. As the pressure in the chamber is higher than the pump pressure, leakage is prevented. A dosing pump or a special pressure intensifier generates the seal chamber pressure.

Variant	Description
CR MAGdrive	Magnetically driven pumps for industrial applications. Key applications are industrial processes involving the handling of aggressive, environmental, dangerous or volatile liquids, e.g. organic compounds, solvents, etc.

Pumps

Variant	Description
Horizontally mounted pump	For safety or height reasons, certain applications, for instance on ships, require the pump to be mounted in the horizontal position. For easy installation the pump is fitted with brackets that support motor and pump.
Low-temperature pump	Exposed to temperatures down to -40 °C, coolant pumps may require neck rings with a different diameter in order to prevent impeller drag.
High-speed pump up to 47 bar	For high-pressure applications, Grundfos offers a unique pump capable of generating a pressure of up to 47 bar. The pump is fitted with a high-speed motor, type MGE. The direction of rotation is the opposite of that of standard pumps, and the chamber stack is turned upside-down, as a result of which the pumped liquid flows in the opposite direction.
High-pressure pump up to 47 bar	For high-pressure applications, Grundfos offers a unique double pump system capable of generating a pressure of up to 47 bar.
Low-NPSH pump (improved suction)	Recommended for boiler-feed applications where cavitation may occur due to poor inlet conditions.
Pump with bearing flange	The bearing flange is suitable for applications where the inlet pressure is higher than the maximum pressure recommended. The bearing flange increases the life of motor bearings. Recommended for standard motors.
Belt-driven pump	Belt-driven pumps designed to operate in places with limited space or where no electrical power is available.
Pump for pharmaceutical and biotechnological applications	CRN(E) pumps designed for applications requiring the sterilisation and CIP capability of pipes, valves and pumps. (CIP = Cleaning-In-Place.)

Connections and other variants

Variant	Description
Pipe connections	In addition to the wide range of standard flange connections, a 16 bar DIN standard clamping flange is available. Customized flanges are available according to specifications.
TriClamp connection	TriClamp connections are of a hygienic design with a sanitary coupling for use in the pharmaceutical and food industry.
Electropolished pump	To substantially reduce the risk of corrosion of the materials. For use in the pharmaceutical and food industry.

11. Further product documentation

WebCAPS

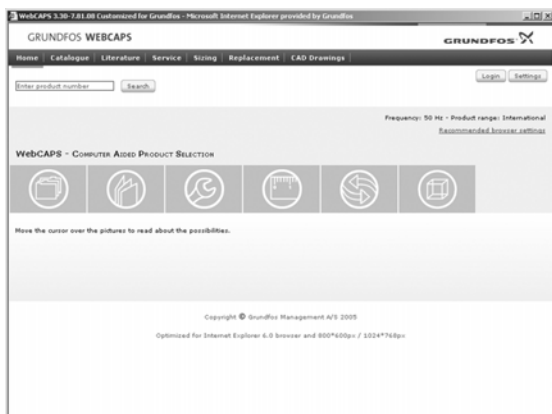

WebCAPS is a **Web-based Computer Aided Product Selection** program available on www.grundfos.com. WebCAPS contains detailed information on more than 220,000 Grundfos products in more than 30 languages.

Information in WebCAPS is divided into six sections:

- Catalogue
- Literature
- Service
- Sizing
- Replacement
- CAD drawings.

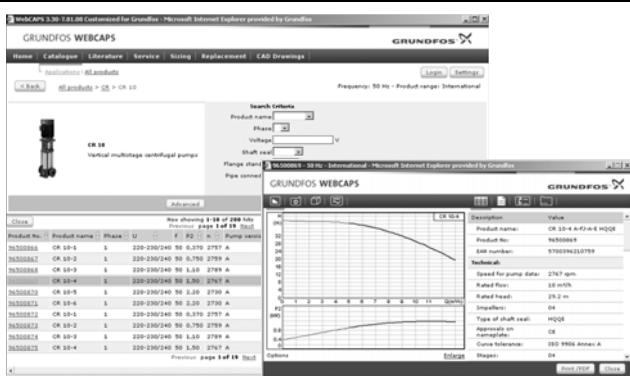

Catalogue

Based on fields of application and pump types, this section contains the following:

- technical data
- curves (QH, Eta, P1, P2, etc.) which can be adapted to the density and viscosity of the pumped liquid and show the number of pumps in operation
- product photos
- dimensional drawings
- wiring diagrams
- quotation texts, etc.

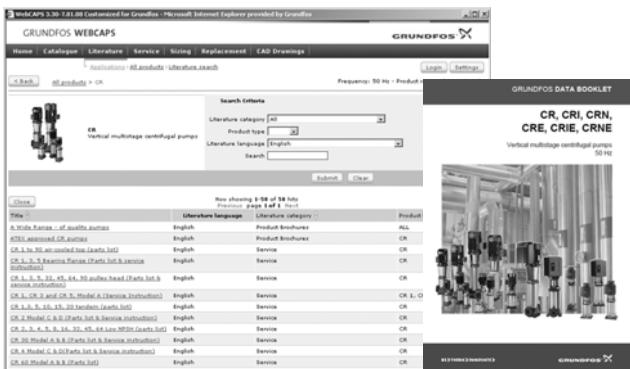

Literature

This section contains all the latest documents of a given pump, such as

- data booklets
- installation and operating instructions
- service documentation, such as Service kit catalogue and Service kit instructions
- quick guides
- product brochures.



Service

This section contains an easy-to-use interactive service catalogue. Here you can find and identify service parts of both existing and discontinued Grundfos pumps. Furthermore, the section contains service videos showing you how to replace service parts.



Sizing

This section is based on different fields of application and installation examples and gives easy step-by-step instructions in how to size a product:

- Select the most suitable and efficient pump for your installation
- Carry out advanced calculations based on energy consumption, payback periods, load profiles, life cycle costs, etc.
- Analyse your selected pump via the built-in life cycle cost tool
- Determine the flow velocity in wastewater applications, etc.



Replacement

In this section you find a guide to selecting and comparing replacement data of an installed pump in order to replace the pump with a more efficient Grundfos pump. The section contains replacement data of a wide range of pumps produced by other manufacturers than Grundfos.

Based on an easy step-by-step guide, you can compare Grundfos pumps with the one you have installed on your site. When you have specified the installed pump, the guide will suggest a number of Grundfos pumps which can improve both comfort and efficiency.

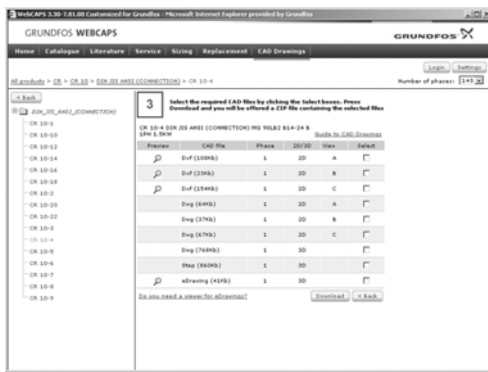

CAD drawings

In this section, it is possible to download 2-dimensional (2D) and 3-dimensional (3D) CAD drawings of most Grundfos pumps.

These formats are available in WebCAPS:

2-dimensional drawings:

- .dxf, wireframe drawings
- .dwg, wireframe drawings.

3-dimensional drawings:

- .dwg, wireframe drawings (without surfaces)
- .stp, solid drawings (with surfaces)
- .eprt, E-drawings.

WinCAPS



Fig. 28 WinCAPS CD-ROM

WinCAPS is a **Windows-based Computer Aided Product Selection** program containing detailed information on more than 220,000 Grundfos products in more than 30 languages.

The program contains the same features and functions as WebCAPS, but is an ideal solution if no internet connection is available.

WinCAPS is available on CD-ROM and updated once a year.

Subject to alterations.

V7023751 0611
Repl. V7023751 1209

GB

ECM: 1077986

The name Grundfos, the Grundfos logo, and the payoff Be-Think-Innovate are registered trademarks owned by Grundfos Management A/S or Grundfos A/S, Denmark. All rights reserved worldwide.