



# THERMOSTAT

Edition V

[www.cnymt.com](http://www.cnymt.com)

[www.chinathermostat.cn](http://www.chinathermostat.cn)

Email: [sales@cnymt.com](mailto:sales@cnymt.com) [mt@cnymt.com](mailto:mt@cnymt.com)

Yuyao Mingtong Electric Appliance CO.,LTD

Address: Linpu, Linshan Town, Yuyao, Zhejiang, China.

TEL: +86-574-62035777 62078777

FAX: +86-574-62037173

P.C.: 315462

YUYAO MINGTONG ELECTRIC APPLIANCE CO.,LTD

Yuyao Mingtong Electric Appliance CO.,LTD is located in Ningbo of China, nearly next to Ningbo Port or Shanghaiport.

Our company manufacture all kinds of thermostats and different refrigeration spare parts. Products mainly used in refrigerator, freezer, A/C, water cooler, showcase, bottle cooler,water dispenser, water heater, washingmachine, oven etc.

The company has team of highly skilled professionals.it also have advance automatic temperature detection equipments, experiment instruments,detection instruments and measure instruments. Company has got many certificate like: UL,TUV,CE,CQC,ROHS,CB,ISO9001,EX-PROOF.

Our company have already entered in international markets while being sold in domestic markets. Nowadays,our products have been exported to Europe, Amercia, South Amercia, South Africa ,Southeast Asia andAfrica etc.

Mingtong will be dedicated to provide service for all the customer in the world.

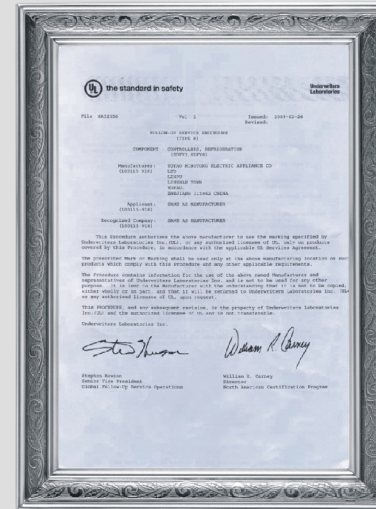

UL



TUV COOLING



TUV HEATING



ISO9001



CQC



CE



CB



EX-PROOF



ROHS

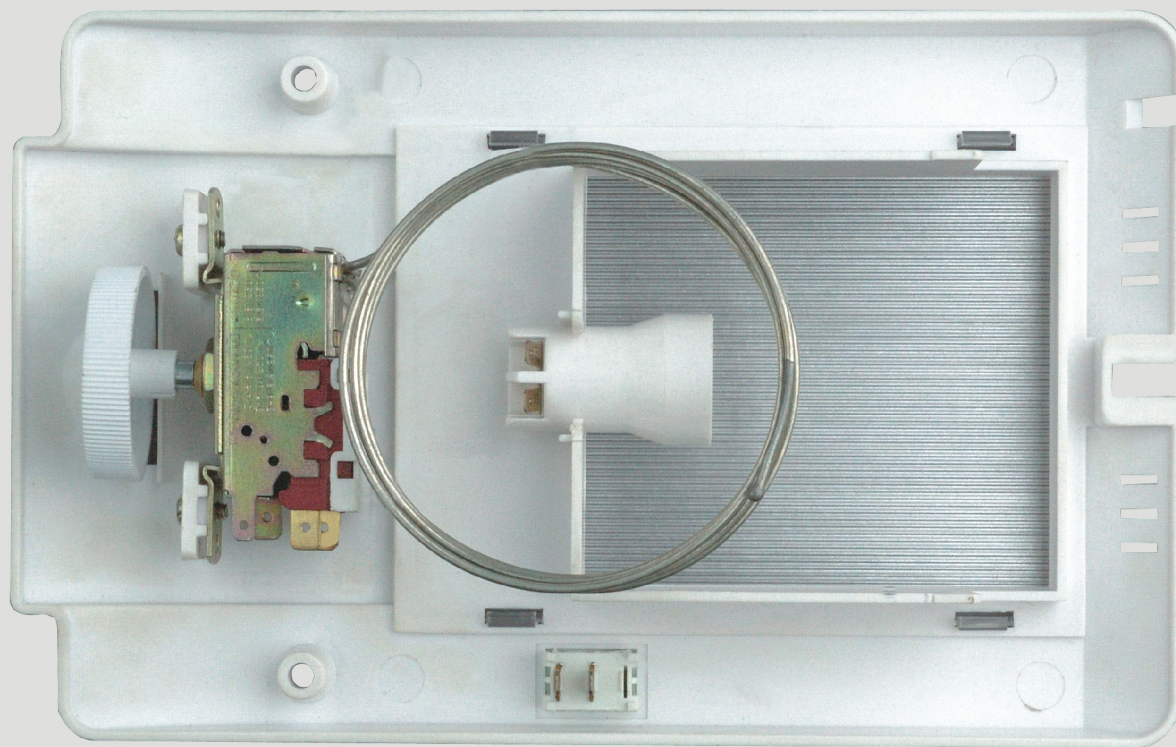

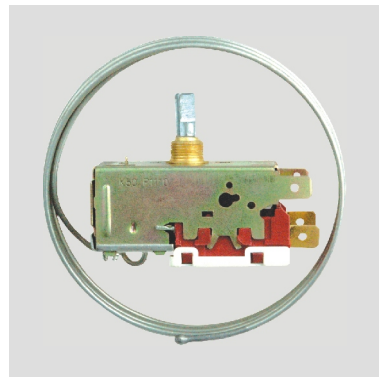

K50-P1110 (VC1)



K50-P1117(VF3)



K50-P1118(VB7)

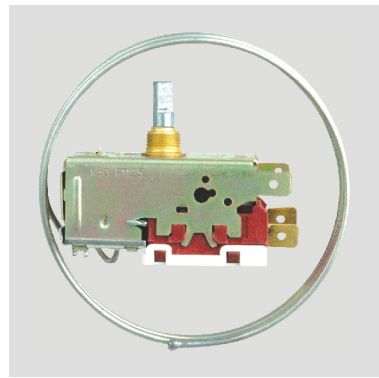

K50-P1125



K50-P1126



K50-P1127



K50-P1557

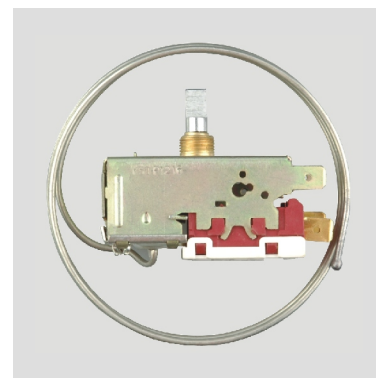

K50-P1216

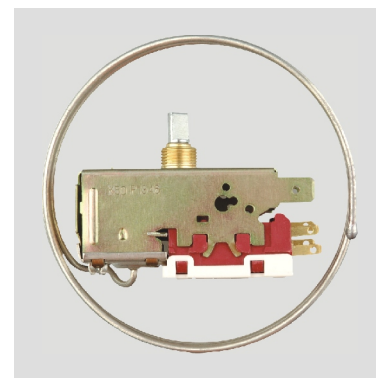

K50-P1346

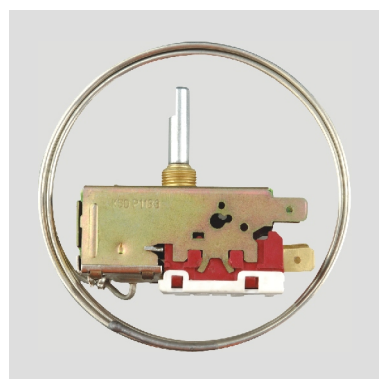

K50-P1133

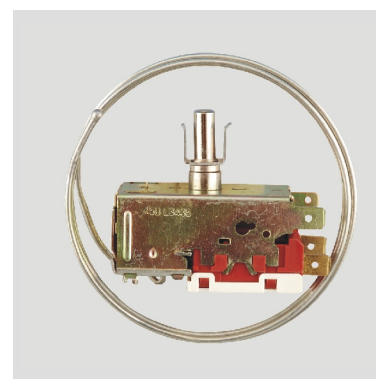

K50-P3435



K54-P1102(VS5)



K54-P3100

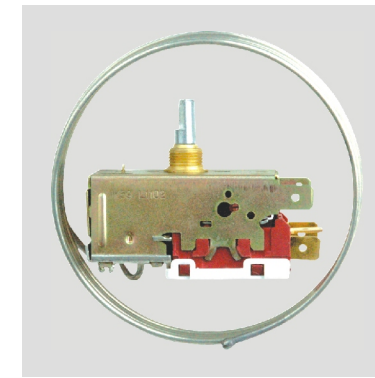

K54-P1118



K54-P1168

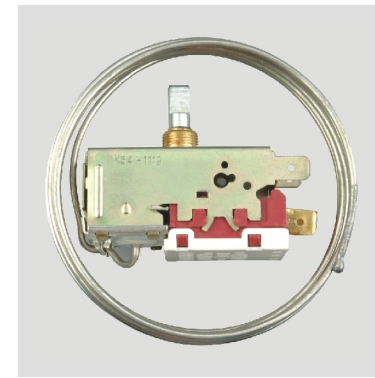

K54-L1119

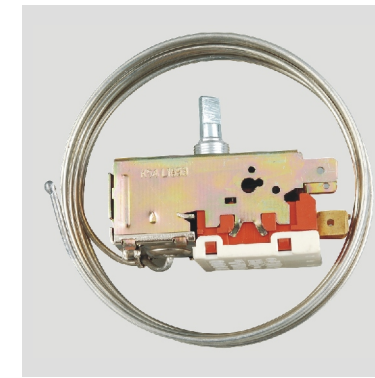

K54-L1853

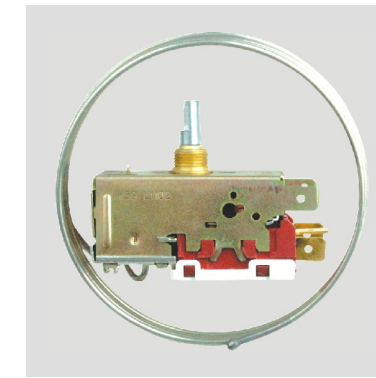

K59-L1102(VT9)

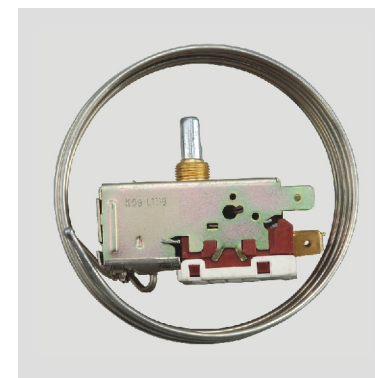

K59-L1119



K59-L1132

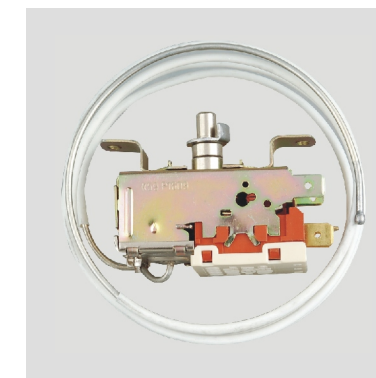

K59-L1609



K50-P1179



K59-L1035



K59-L1076

Parts for refrigerator, freezer, air-conditioner, water-dispenser, water heater, oven etc home appliance.  
 Manufacture all kinds of models with different temperature and capillary length according to clients' requirements.

Parts for refrigerator, freezer, air-conditioner, water-dispenser, water heater, oven etc home appliance.  
 Manufacture all kinds of models with different temperature and capillary length according to clients' requirements.



K59-L3111



K60-P1129

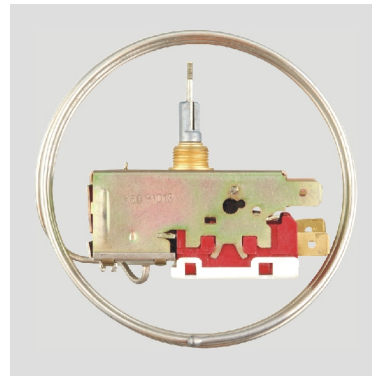

K60-P1013(VP4)

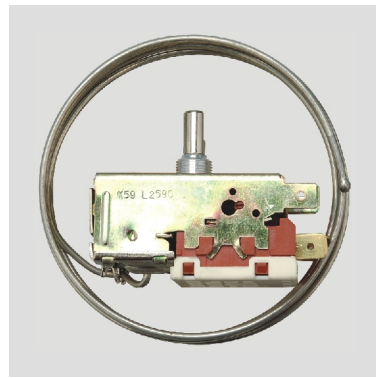

K59-L2590

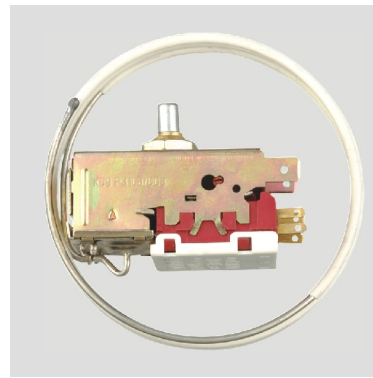

K59-P3013

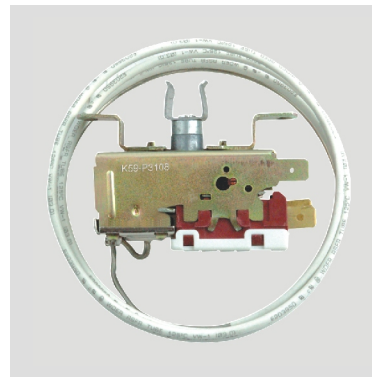

K59-P3108



K59-L1620(VX0)



K59-L1662(VT93)

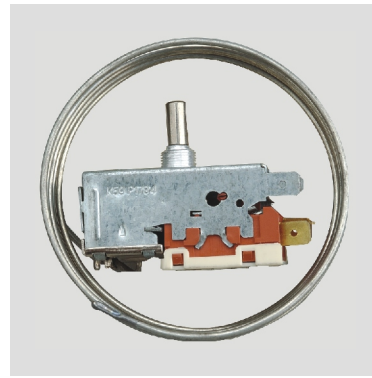

K59-L1784(VX03)



K57-P2077(VT72)

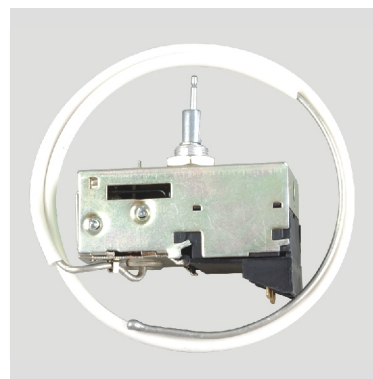

K60-INDIA



WP2

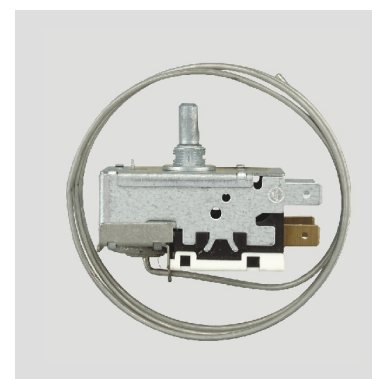

T205

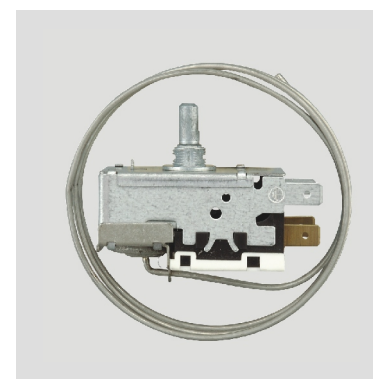

T205A45

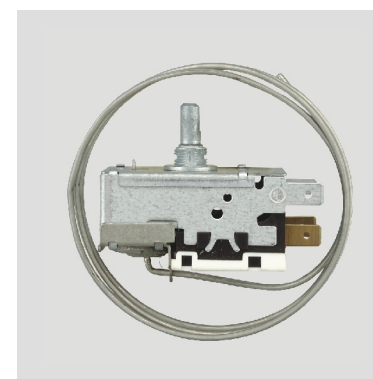

T205A46

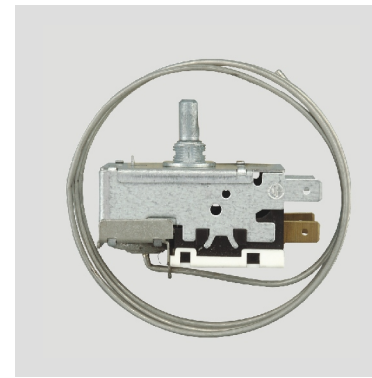

T205A71



T205A75



T205A92

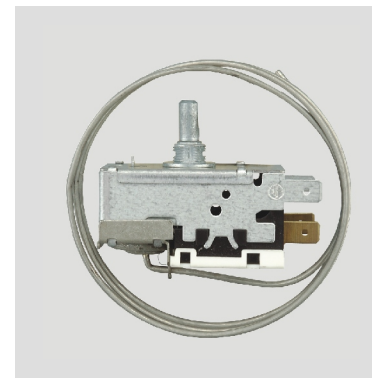

T205A93

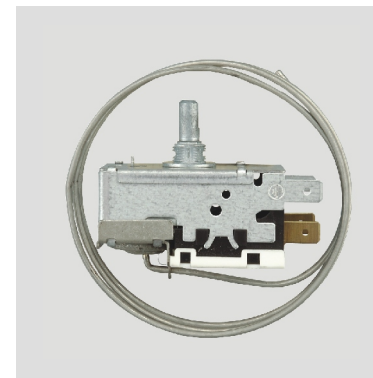

T207A45

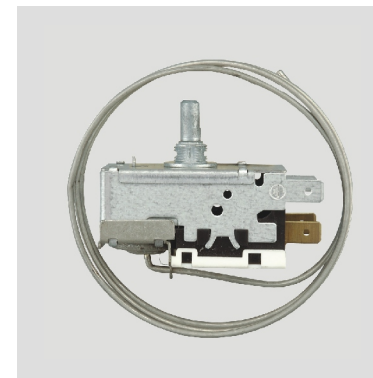

T207A47

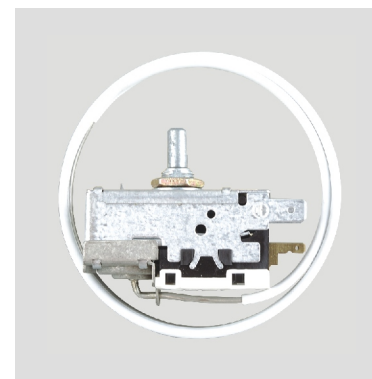

T229A139



T229A70VET9

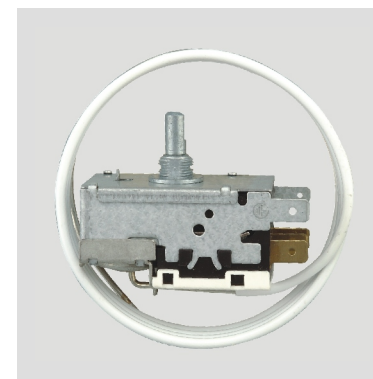

T229A74VET9

Parts for refrigerator, freezer, air-conditioner, water-dispenser, water heater, oven etc home appliance.  
 Manufacture all kinds of models with different temperature and capillary length according to clients' requirements.

Parts for refrigerator, freezer, air-conditioner, water-dispenser, water heater, oven etc home appliance.  
 Manufacture all kinds of models with different temperature and capillary length according to clients' requirements.



PFN-163A



PFN-110UA



WPF23.5

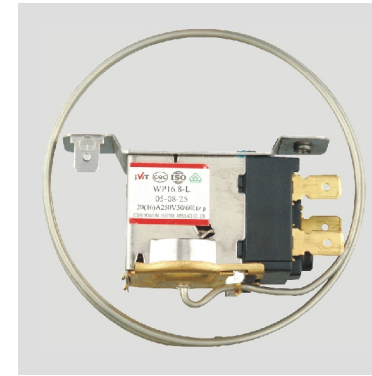

WP16.8



AWTB-1002

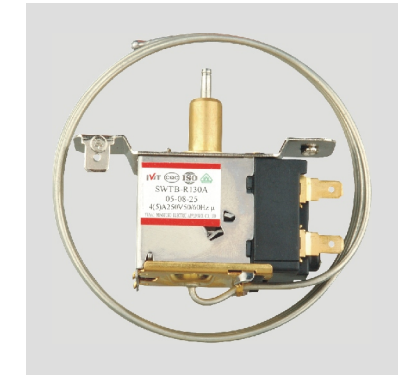

SWTB-R130A



AWTB-P132



AWTB-P133



AWTB-P134



WSF19.5



PFA-604G



PFA-606S



AWTB-P135

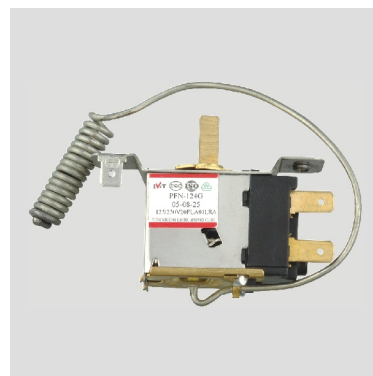

PFN-124G



AWTB-1238



A10-1580-057

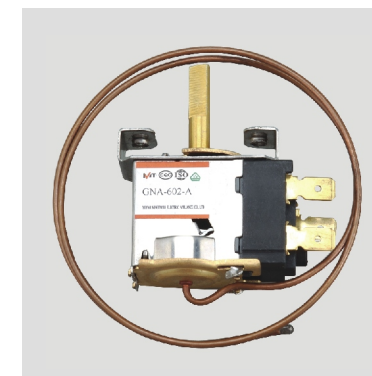

GNA-602D

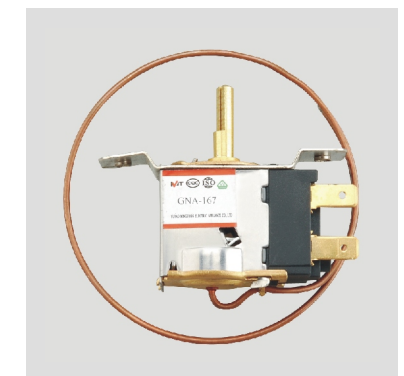

GNA-167



AWTB-4226



PFN-150M



WDF18

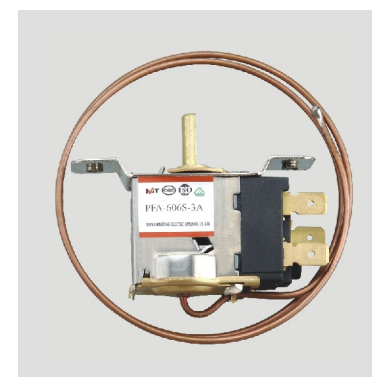

PFA-606S-3A

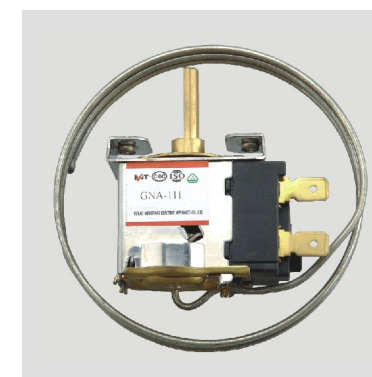

GNA-111



PFA-111A

Parts for refrigerator, freezer, air-conditioner, water-dispenser, water heater, oven etc home appliance.  
 Manufacture all kinds of models with different temperature and capillary length according to clients' requirements.

Parts for refrigerator, freezer, air-conditioner, water-dispenser, water heater, oven etc home appliance.  
 Manufacture all kinds of models with different temperature and capillary length according to clients' requirements.

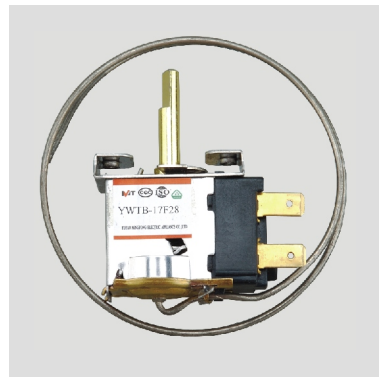

YWTB-17F28



PFN-C171



WDF23



WP1A



WP1.5A



WP2A



WP2.5A



WP4A



PFN174S-03EB



PFN174S-03EC



AWTB-173-05



PFN174S-03F



PFA-606W

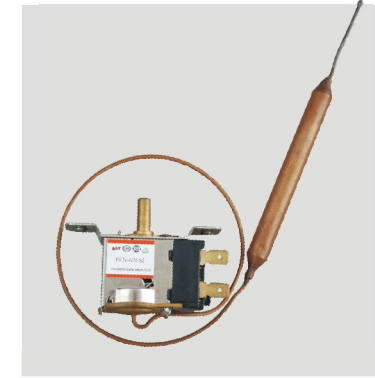

PFN-606SI



PFA-602D



PFN-604G

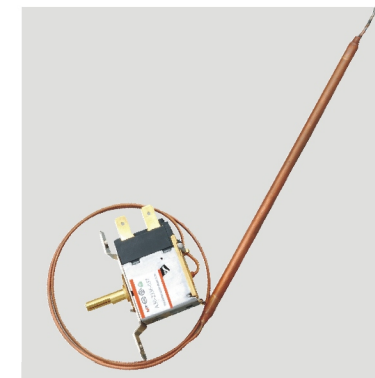

A30-2336-057



A22-1254-057(3PIN)

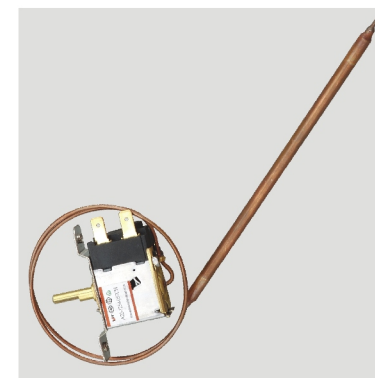

A22-1254-057(2PIN)

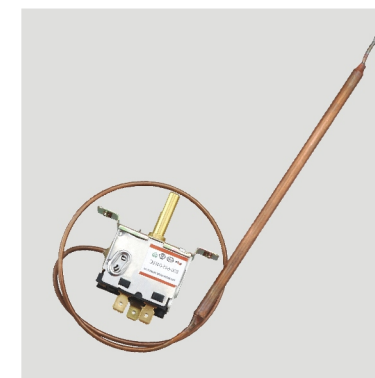

800-645-04(3PIN)

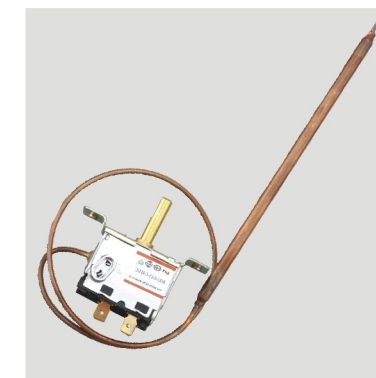

800-645-04(2PIN)



DAMPER 358



DAMPER 359

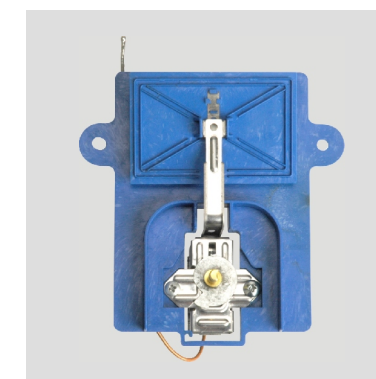

DAMPER 1

Parts for refrigerator, freezer, air-conditioner, water-dispenser, water heater, oven etc home appliance.  
 Manufacture all kinds of models with different temperature and capillary length according to clients' requirements.

Parts for refrigerator, freezer, air-conditioner, water-dispenser, water heater, oven etc home appliance.  
 Manufacture all kinds of models with different temperature and capillary length according to clients' requirements.

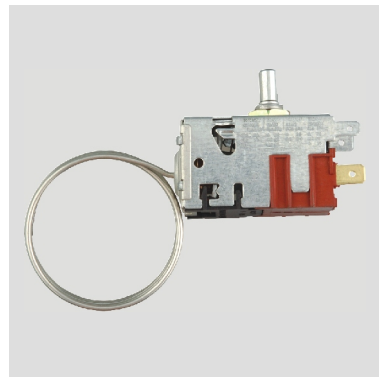

077B0021

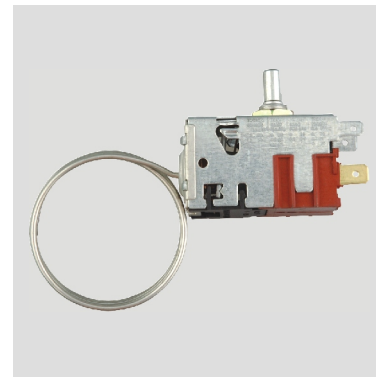

077B0023

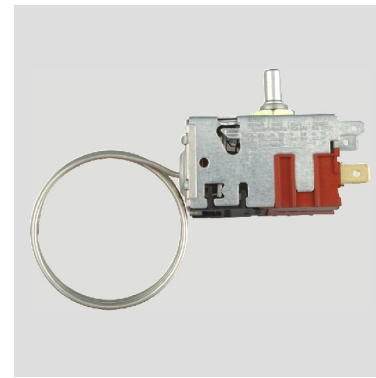

077B0027

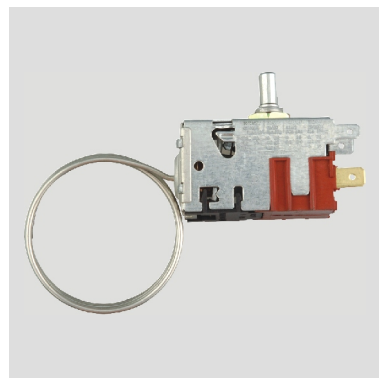

077B0028

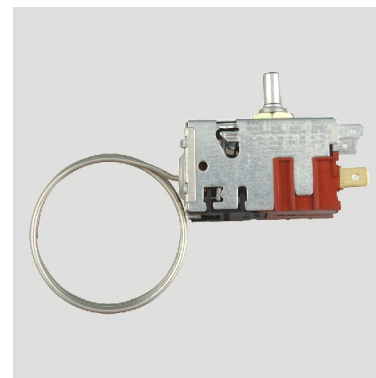

077B1110

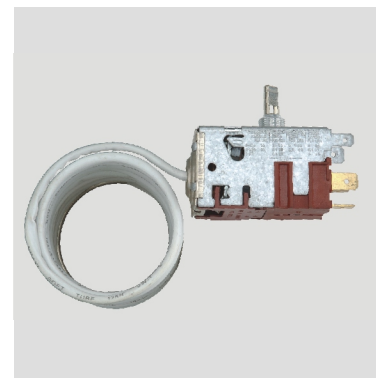

077B2027



077B6208



077B6021



077B6740



077B6221



077B7005

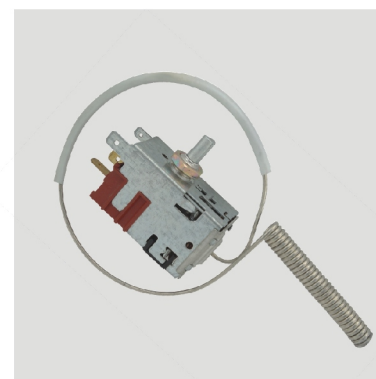

077B1280L

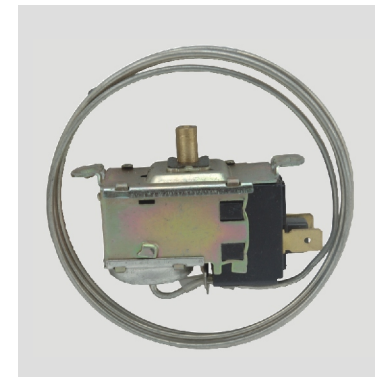

RC13646-2

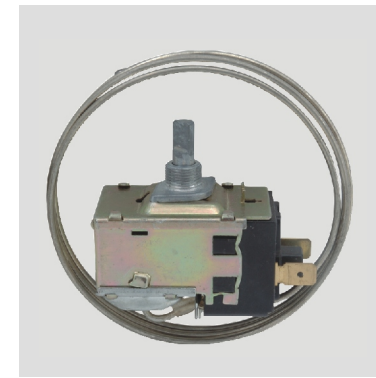

RC13600-3



RC72040-6

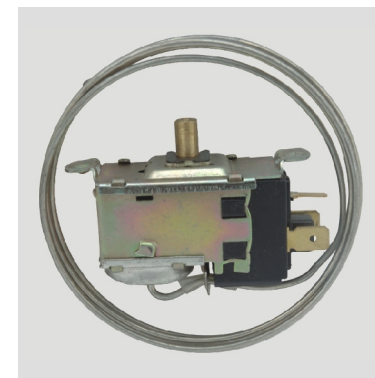

RC23626-2

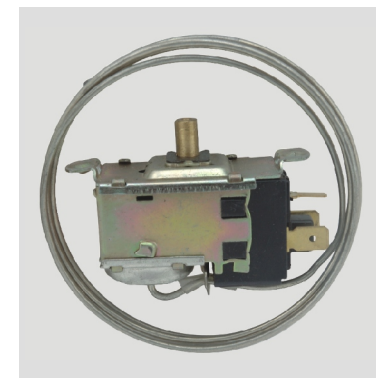

RC23626-4

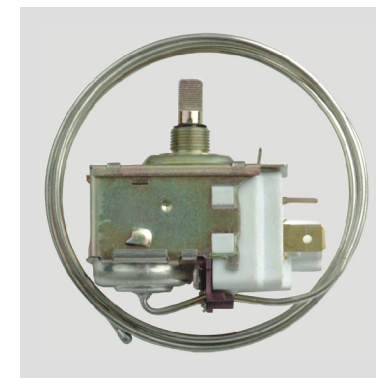

RC23669-2

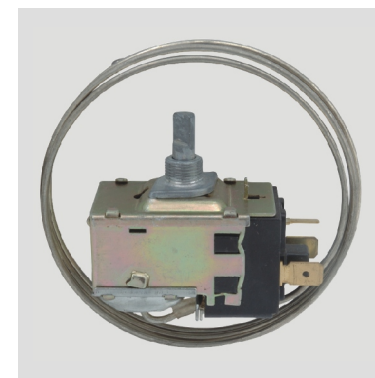

RC23669-4

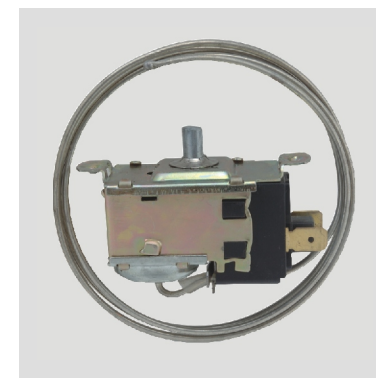

RCR2027-4

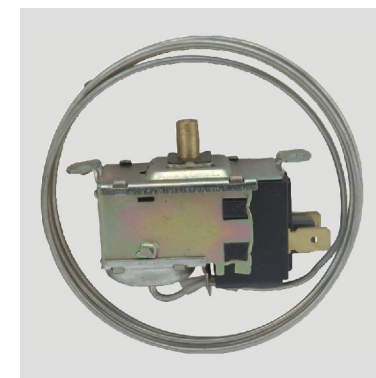

RFR4070-2

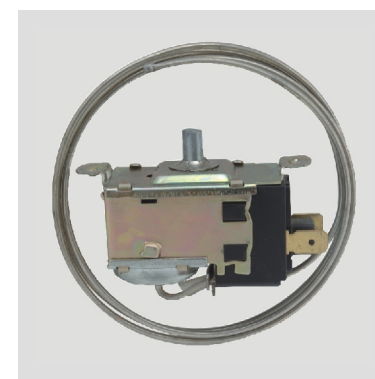

RFR4000-4

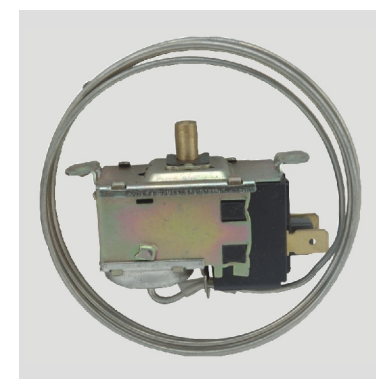

RC45070-2

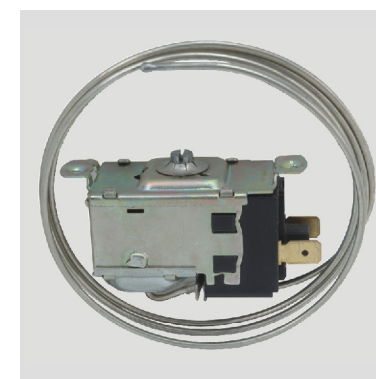

RC43622-2

Parts for refrigerator, freezer, air-conditioner, water-dispenser, water heater, oven etc home appliance.  
 Manufacture all kinds of models with different temperature and capillary length according to clients' requirements.

Parts for refrigerator, freezer, air-conditioner, water-dispenser, water heater, oven etc home appliance.  
 Manufacture all kinds of models with different temperature and capillary length according to clients' requirements.

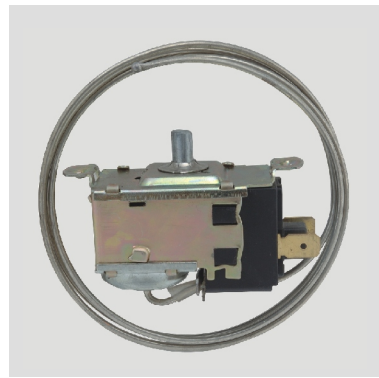

RC53600-2



RC53670-4

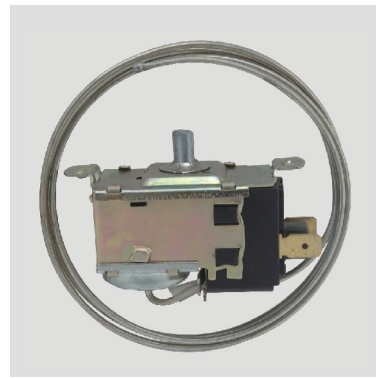

RC53626-2

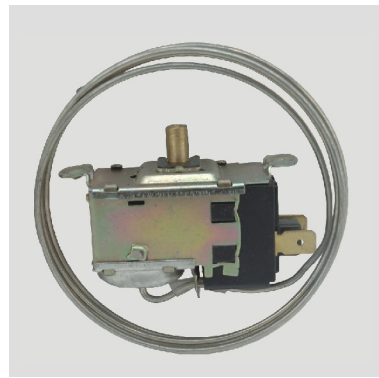

RCR7272-2

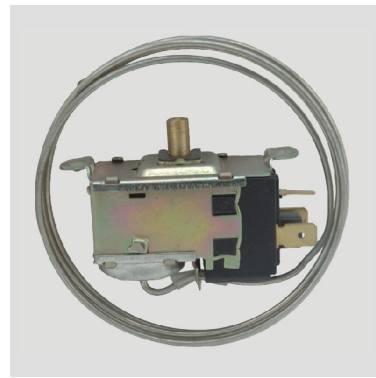

RC94072-2



RC94072-4

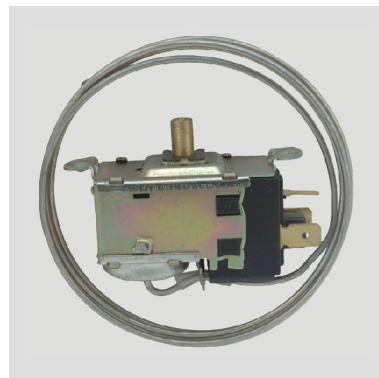

RC93672-2

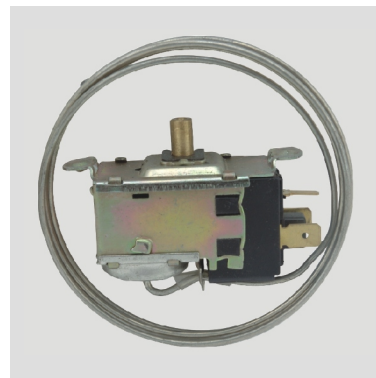

RC94522-2

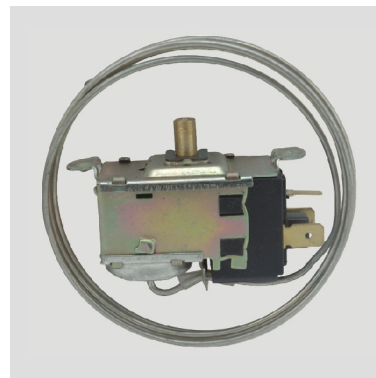

RC92326-2

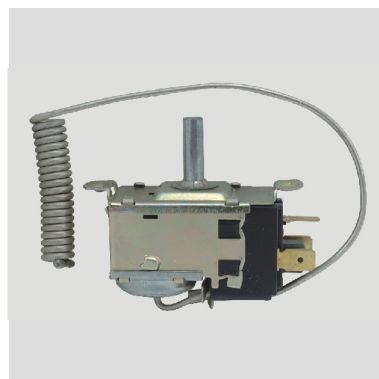

TSV5002-09



RC14032-2

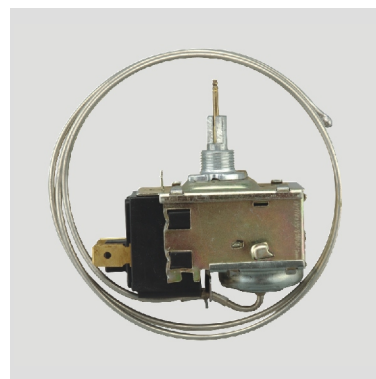

RC02632-4



3ART5VG10



3ART5VC81

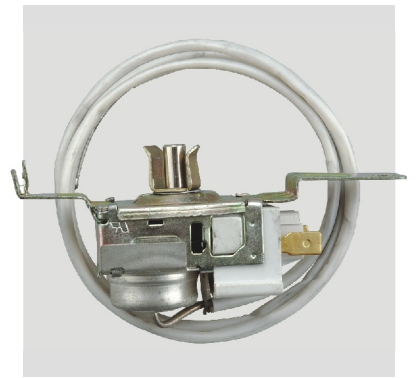

3ART5VN11



3ART5VH39



3ART5LP5



3ART5C212



3ART5VAA14

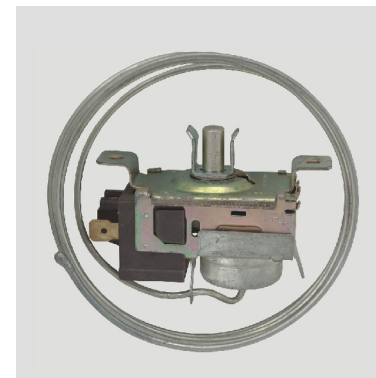

3ART5VAA125



3ART5VAA158

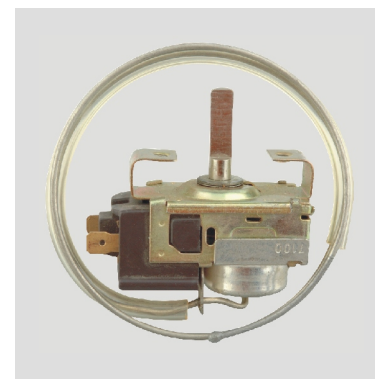

3ART17S5

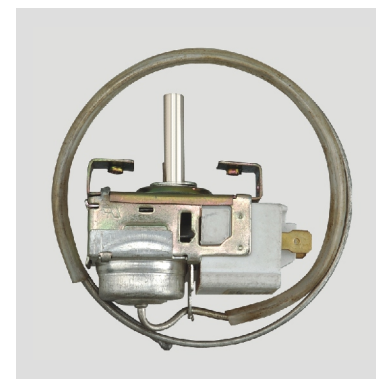

3ART17S8

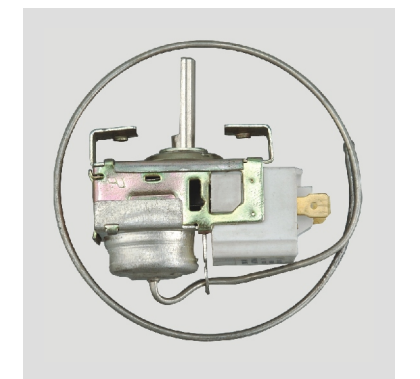

3ART17B6

Parts for refrigerator, freezer, air-conditioner, water-dispenser, water heater, oven etc home appliance.  
 Manufacture all kinds of models with different temperature and capillary length according to clients' requirements.

Parts for refrigerator, freezer, air-conditioner, water-dispenser, water heater, oven etc home appliance.  
 Manufacture all kinds of models with different temperature and capillary length according to clients' requirements.



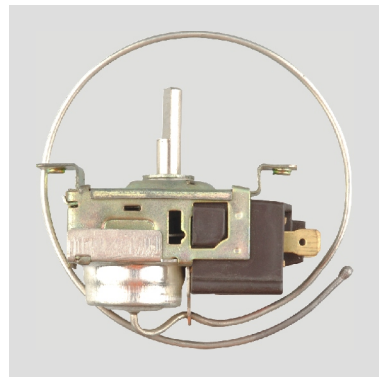

3ART17G60



3ART24F15

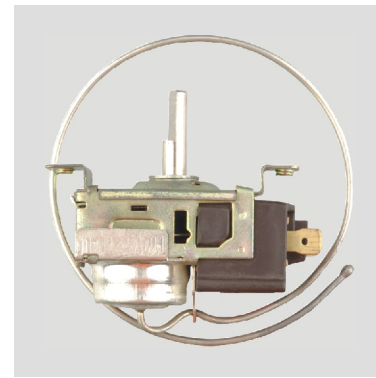

3ART24G28

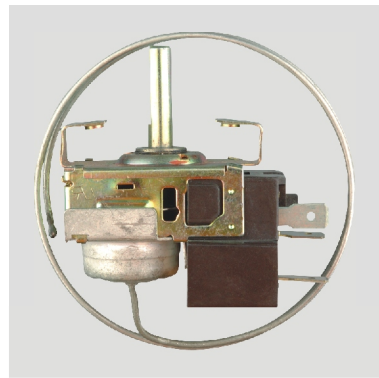

3ART24A144



3ART5VC96



3ART5VC163

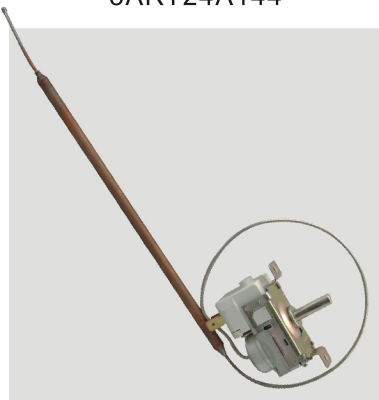

3ART17RE16



3ART17RS28

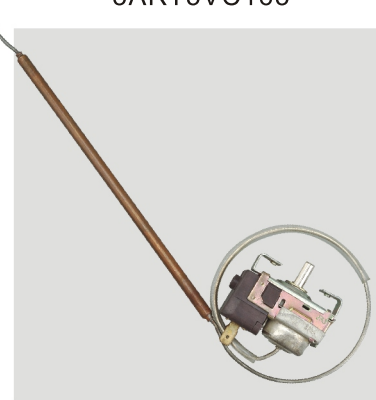

3ART17RL45



3ART24A151



3ART24A165

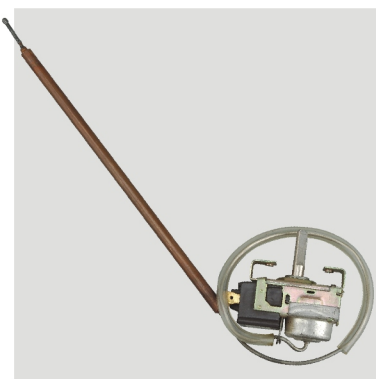

3ART17S9



A01070



A010104



A041000



A13100



A130015

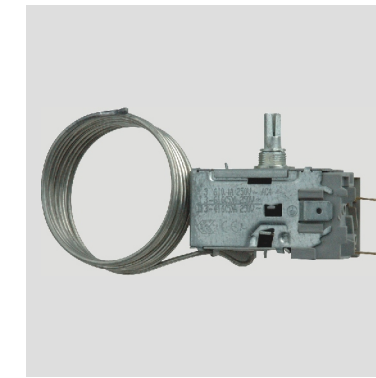

A130050



A130057



A130718



TAM112

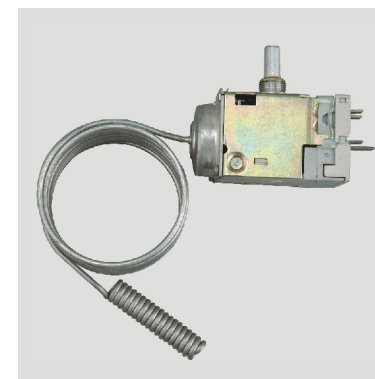

TAM113

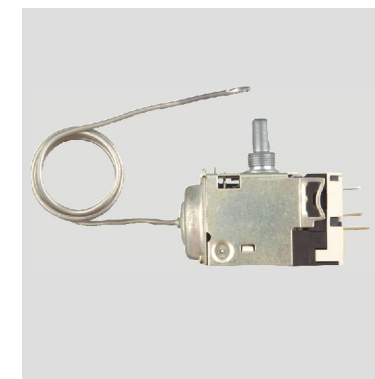

TAM133

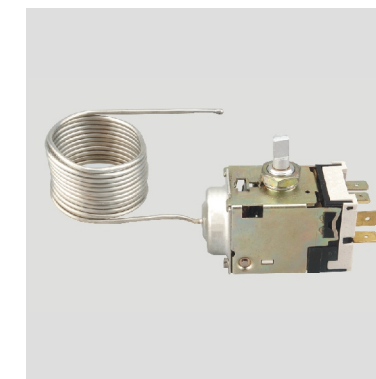

TAM145

Parts for refrigerator, freezer, air-conditioner, water-dispenser, water heater, oven etc home appliance.  
 Manufacture all kinds of models with different temperature and capillary length according to clients' requirements.

Parts for refrigerator, freezer, air-conditioner, water-dispenser, water heater, oven etc home appliance.  
 Manufacture all kinds of models with different temperature and capillary length according to clients' requirements.



A2000

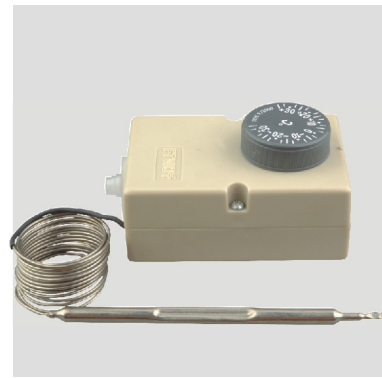

F2000

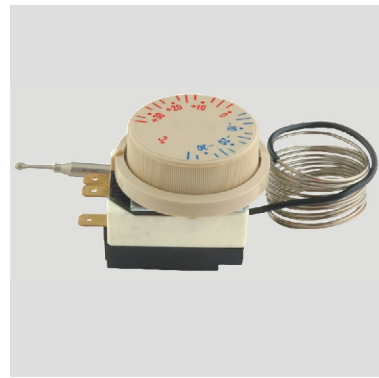

711



CAEM0-40



RTC-01



IMIT



UT72



TY1

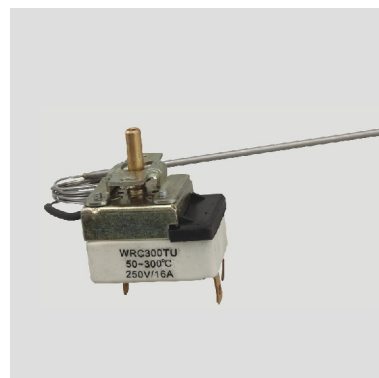

TY2

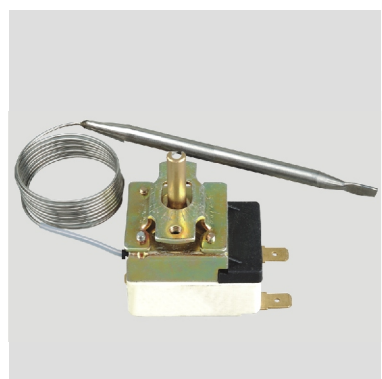

TY3

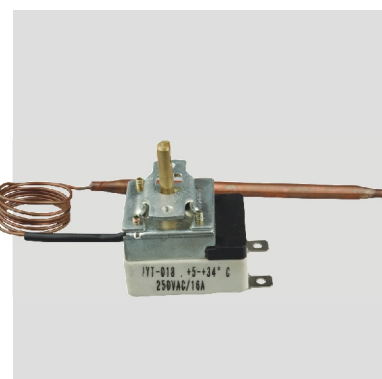

TY5



TY6

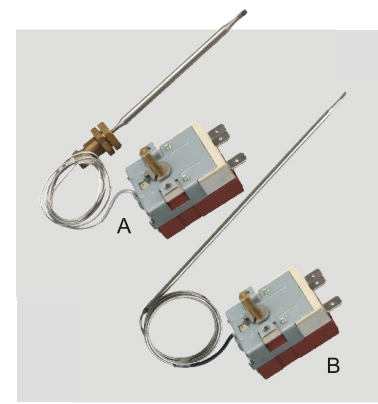

E1



E2



E3

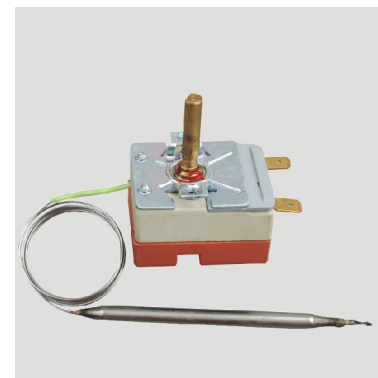

E4

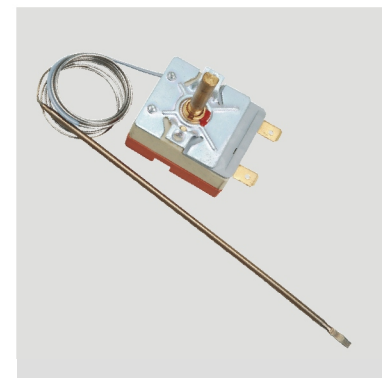

E5



E6



E7



C1



C2



C3



F0



F1

Parts for refrigerator, freezer, air-conditioner, water-dispenser, water heater, oven etc home appliance.  
 Manufacture all kinds of models with different temperature and capillary length according to clients' requirements.

Parts for refrigerator, freezer, air-conditioner, water-dispenser, water-dispenser, oven etc home appliance.  
 Manufacture all kinds of models with different temperature and capillary length according to clients' requirements.



F2

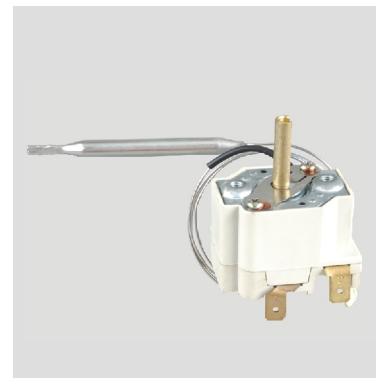

F3

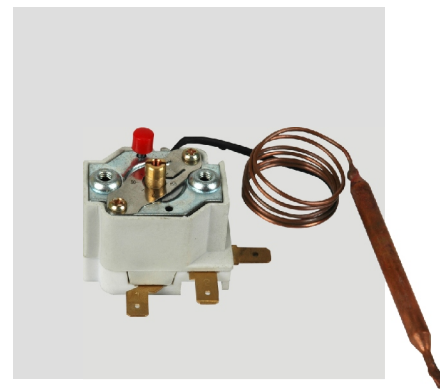

F4



FGS1



380V2

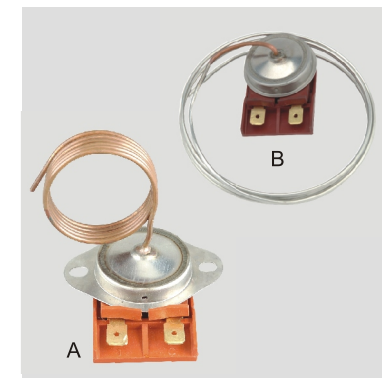

FGS3



ST1

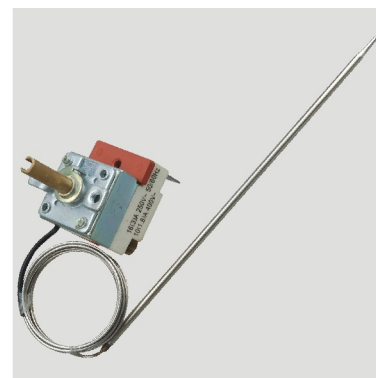

ST2

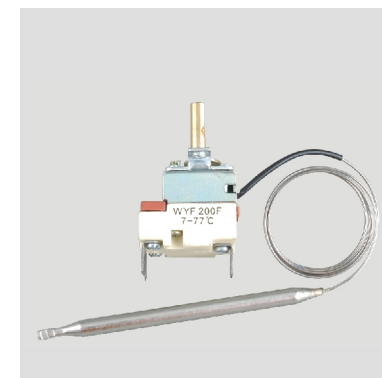

ST3



T8

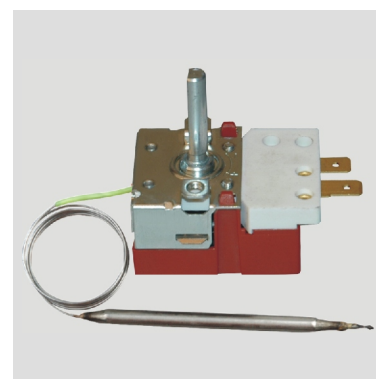

Z1

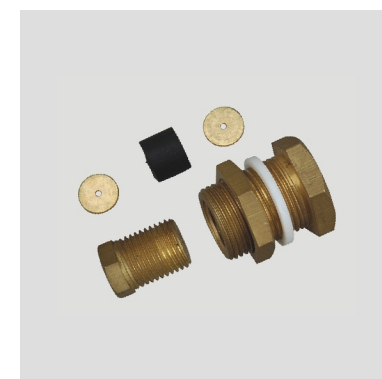

WATER PROOF



R1



R2



R3



R4

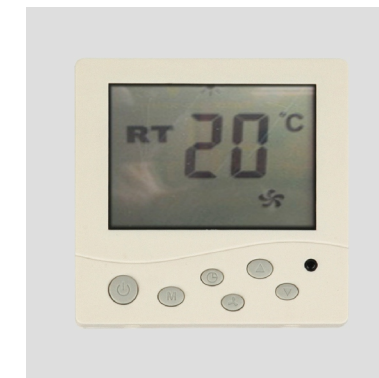

R5



R6



TPM-10



TPM-30



THERMOMETER-1



AC-1



TPM-900



THERMOMETER-2

Parts for refrigerator, freezer, air-conditioner, water-dispenser, water-dispenser, oven etc home appliance.  
 Manufacture all kinds of models with different temperature and capillary length according to clients' requirements.

Parts for refrigerator, freezer, air-conditioner, water-dispenser, water-dispenser, oven etc home appliance.  
 Manufacture all kinds of models with different temperature and capillary length according to clients' requirements.

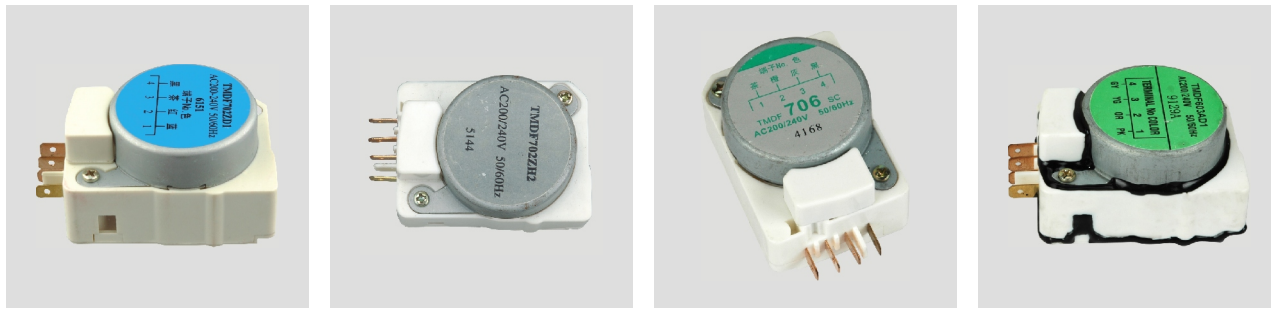

TMDF702ZD1 TMDF702ZH2 TMDF706SC TMDF603AD1

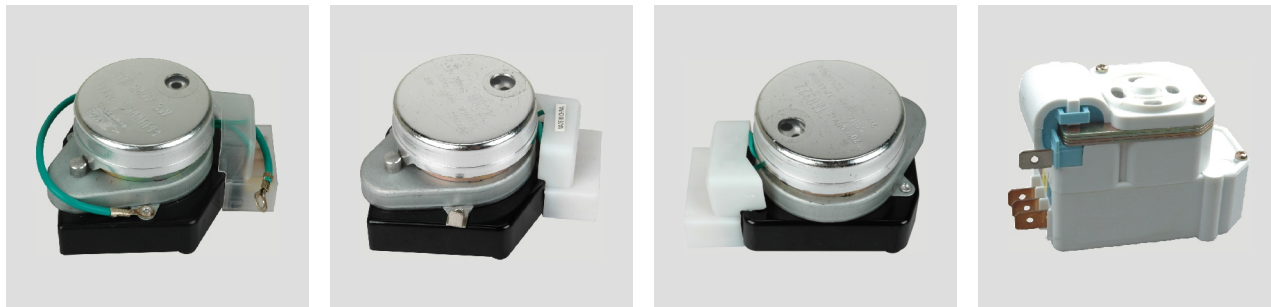

M8322 M8308 M8431 TMDE802PJ1

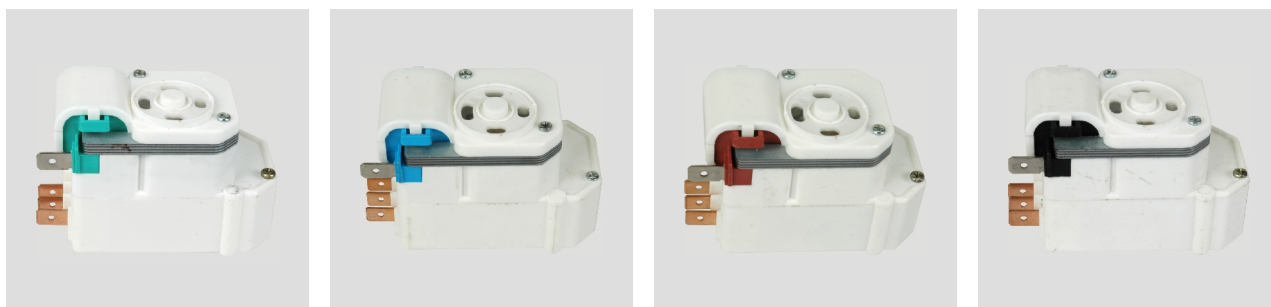

TMDE706SC TMDE1 DBZ912EG2 TMDE2

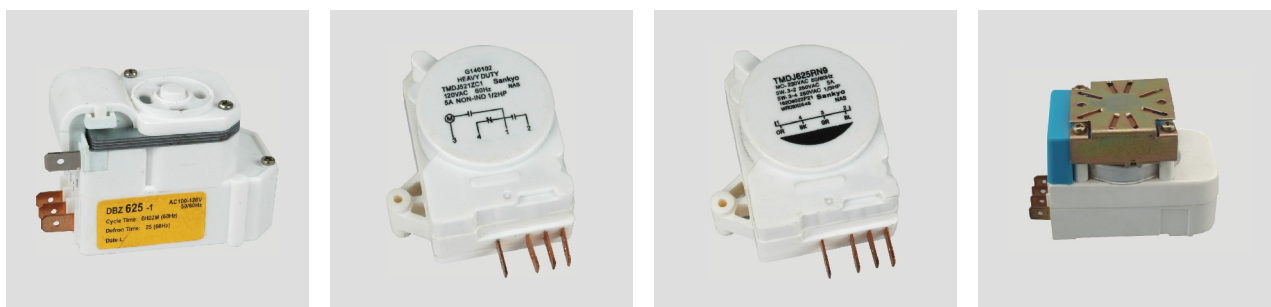

TMDE625-1 TMDJ521ZC1 TMDJ625RN9 TD-20C

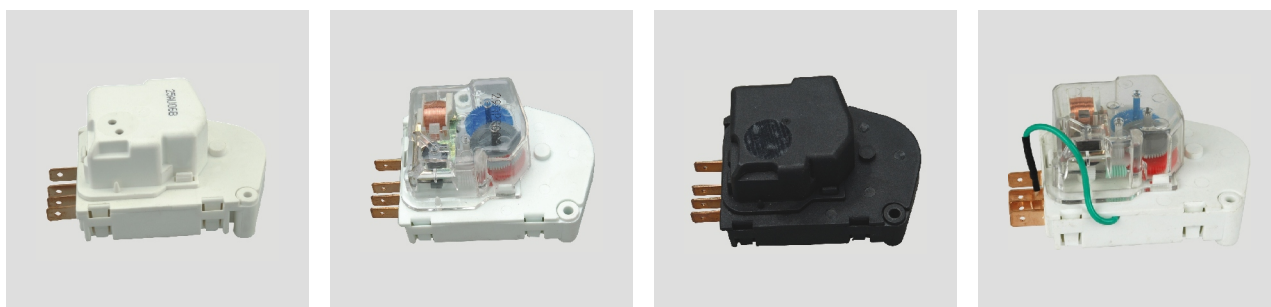

TMDC-1 TMDC-2 TMDC-3 TMDC-4



TMDF702ZD1 TMDF702ZH2 TMDF706SC DEFORST TIMER-1



GH-1 GH-2 GH-3 GH-4



GH-5 GH-6 GH-7 GH-8



MTF-1 MTF-2 MTF-3 MTF-4

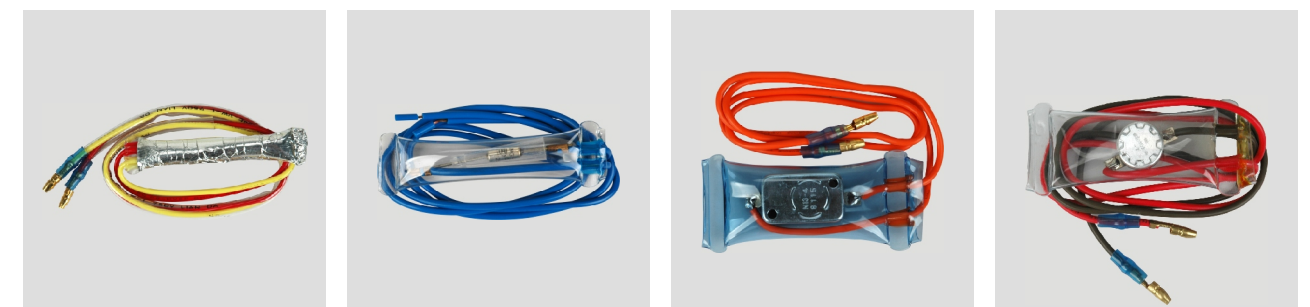

MTF-5 MTF-6 MTF-7 MTF-8

Parts for refrigerator, freezer, air-conditioner, water-dispenser, water-dispenser, oven etc home appliance.  
 Manufacture all kinds of models with different temperature and capillary length according to clients' requirements.

Parts for refrigerator, freezer, air-conditioner, water-dispenser, water-dispenser, oven etc home appliance.  
 Manufacture all kinds of models with different temperature and capillary length according to clients' requirements.



MTF-9

MTF-10

MTF-11

MTF-12



MTF-13

MTF-14

MTJ-1

MTJ-2



MTJ-3

MTJ-4

MTJ-5

MTJ-6

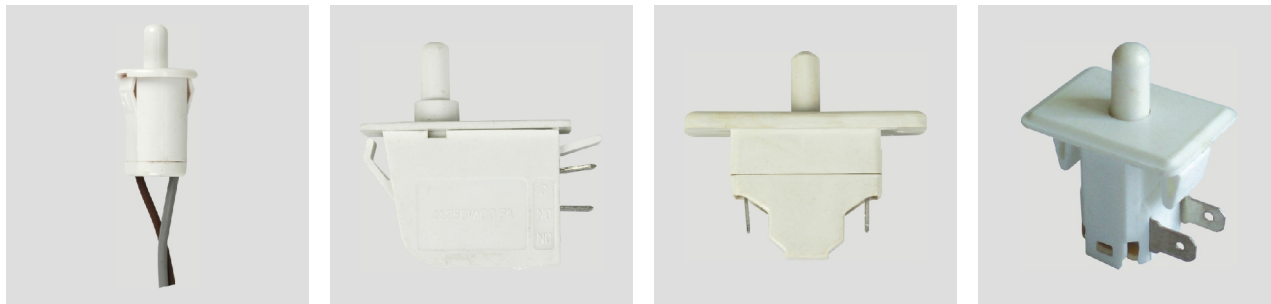

MTJ-7

MTJ-8

MTJ-9

MTJ-10



MTJ-11

MTJ-12

KCD2

KCD3

Parts for refrigerator, freezer, air-conditioner, water-dispenser, water-dispenser, oven etc home appliance.  
 Manufacture all kinds of models with different temperature and capillary length according to clients' requirements.



SWITCH-1

SWITCH-2

SWITCH-3

SWITCH-4



SWITCH-5

PLASTIC PROFILE

LAMP HOLDER

LAMP-1



WATER BOX

ELECTRIC BOX

HINGE-1

HINGE-2

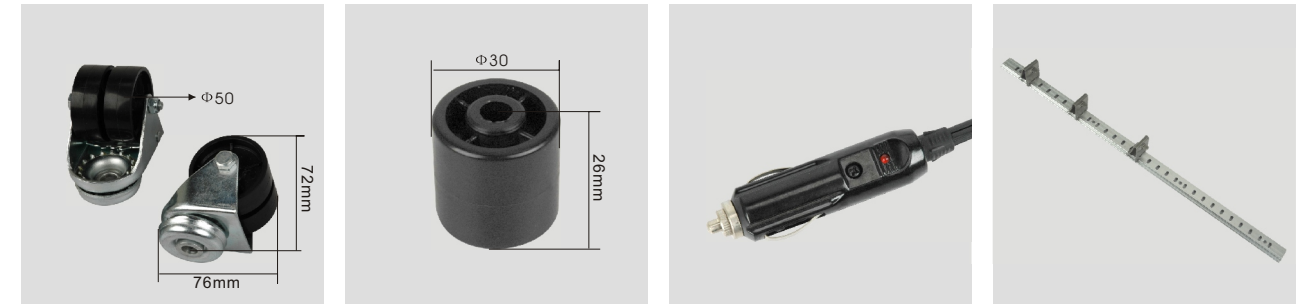

FREEZER WHEEL-1

FREEZER WHEEL-2

CIGAR LIGHTER

SHELF HOLDER



LOCK-1

LOCK-2

LOCK-3

LED LIGHT-1

Parts for refrigerator, freezer, air-conditioner, water-dispenser, water-dispenser, oven etc home appliance.  
 Manufacture all kinds of models with different temperature and capillary length according to clients' requirements.

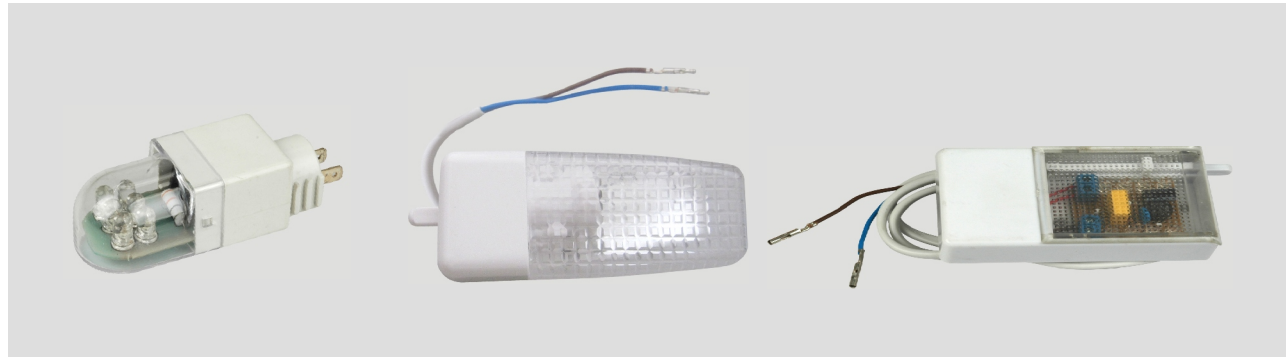

LED LIGHT-2

LAMP BOX-1

LAMP BOX-2



LAMP BOX-3

LAMP BOX-4



LAMP BOX-5

LAMP BOX-6

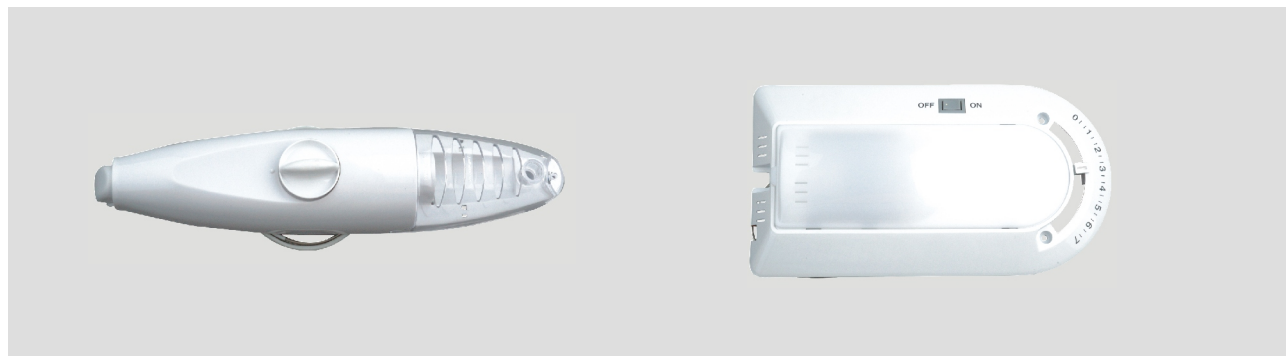

LAMP BOX-7

LAMP BOX-8

Parts for refrigerator, freezer, air-conditioner, water-dispenser, water-dispenser, oven etc home appliance.  
 Manufacture all kinds of models with different temperature and capillary length according to clients' requirements.

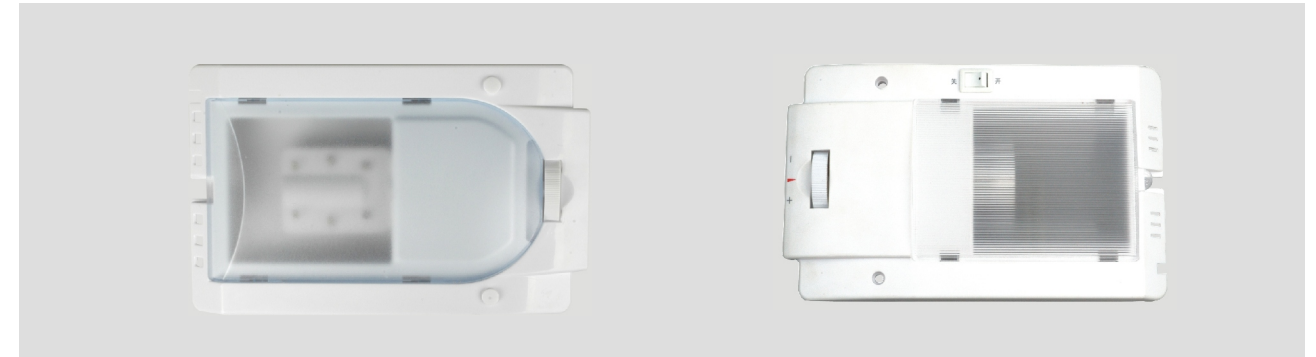

LAMP BOX-9

LAMP BOX-10



PANEL-1

PANEL-2

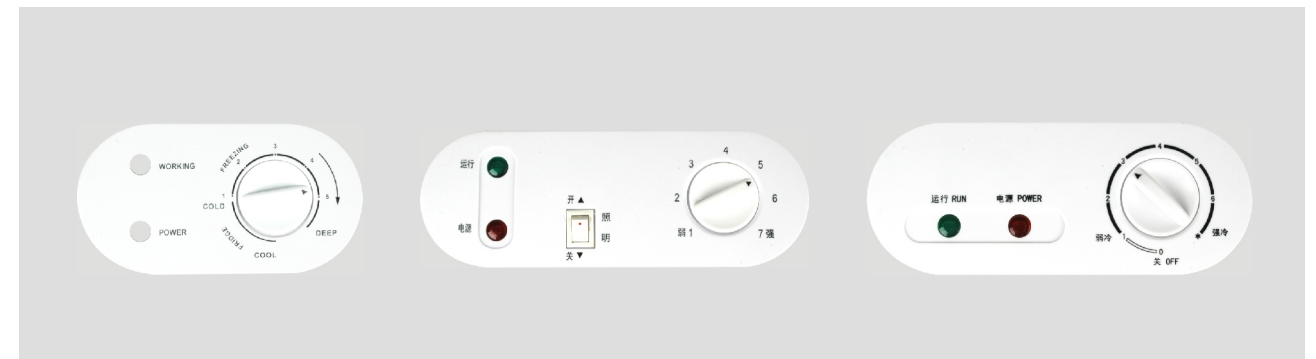

PANEL-3

PANEL-4

PANEL-5

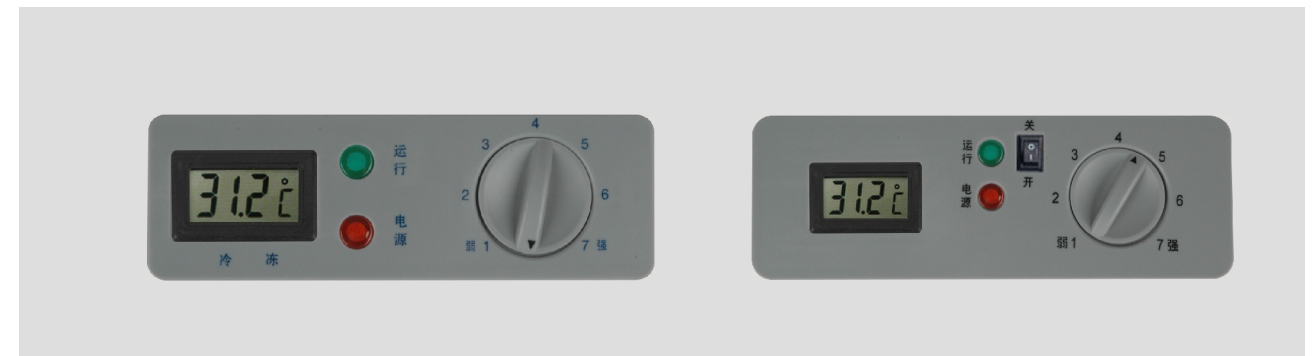

PANEL-6

PANEL-7

Parts for refrigerator, freezer, air-conditioner, water-dispenser, water-dispenser, oven etc home appliance.  
 Manufacture all kinds of models with different temperature and capillary length according to clients' requirements.

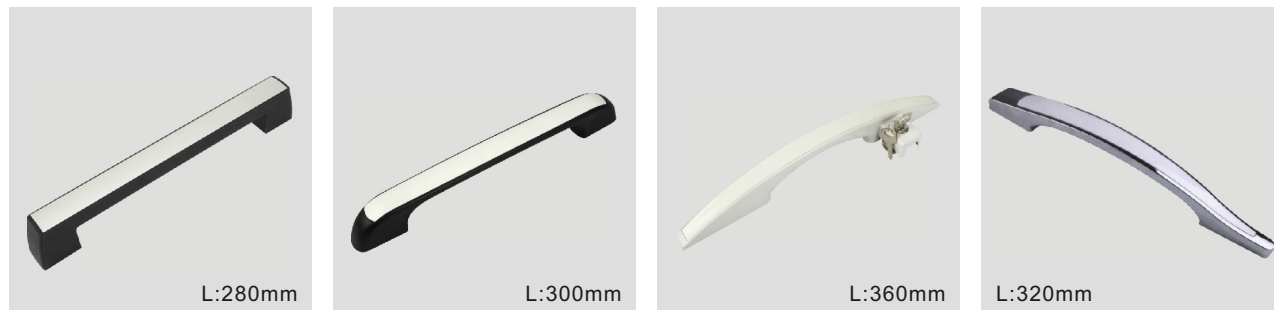

HANDLE-1 HANDLE-2 HANDLE-3 HANDLE-4

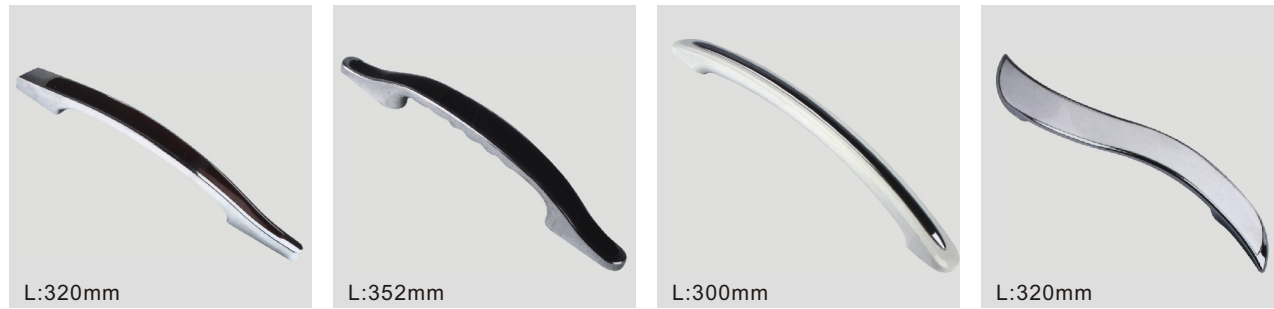

HANDLE-5 HANDLE-6 HANDLE-7 HANDLE-8

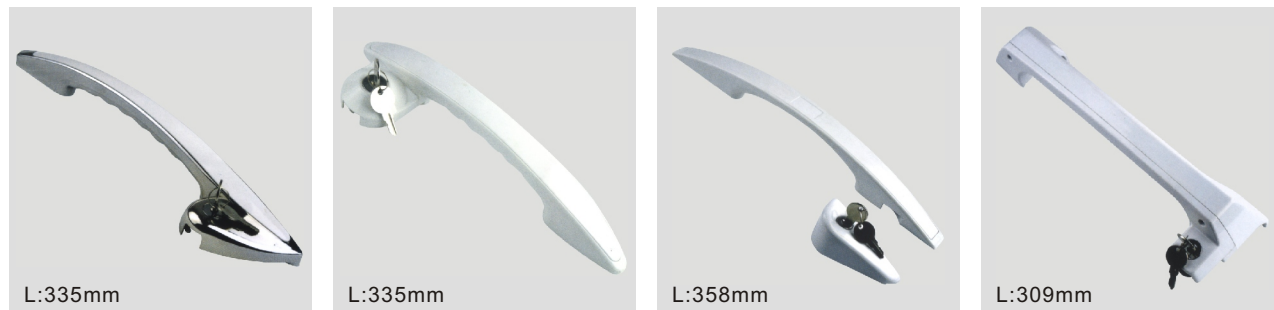

HANDLE-9 HANDLE-10 HANDLE-11 HANDLE-12



HANDLE-13 HANDLE-14 HANDLE-15 HANDLE-16



HANDLE-17 HANDLE-18 HANDLE-19 HANDLE-20

Parts for refrigerator, freezer, air-conditioner, water-dispenser, water-dispenser, oven etc home appliance.  
 Manufacture all kinds of models with different temperature and capillary length according to clients' requirements.



A1 A2 A3 A4 A5



A6 A7 A8 A9 A10



A11 A12 A13 A14 A15



A16 A17 A18 A19 A20



A21 A22 A23 A24 A25 A26 A27

Parts for refrigerator, freezer, air-conditioner, water-dispenser, water-dispenser, oven etc home appliance.  
 Manufacture all kinds of models with different temperature and capillary length according to clients' requirements.

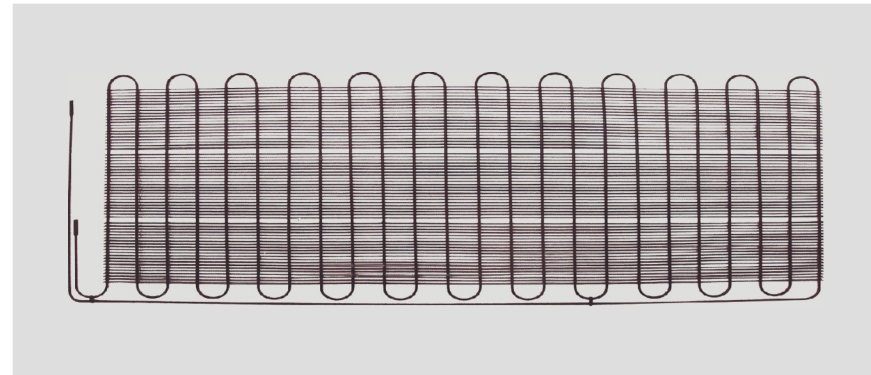

MTR-1



MTR-2

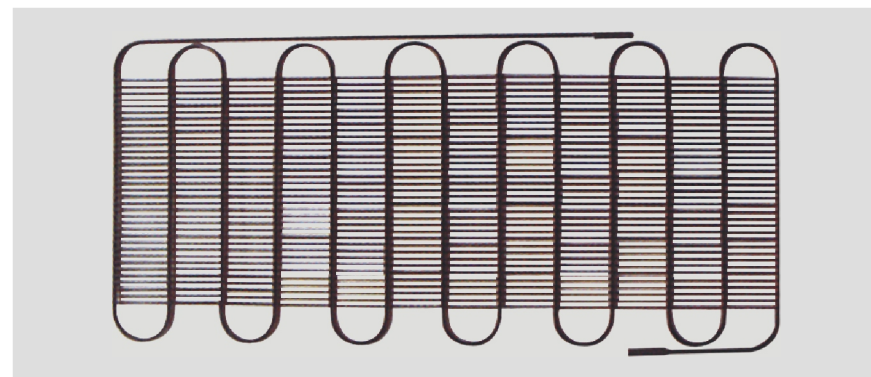

MTR-3



MTR-4

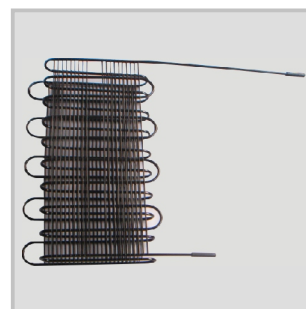

MTR-5

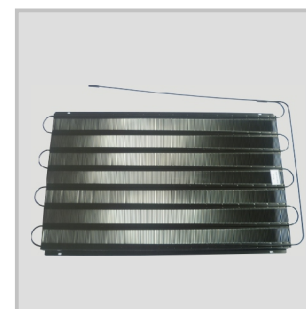

MTR-6

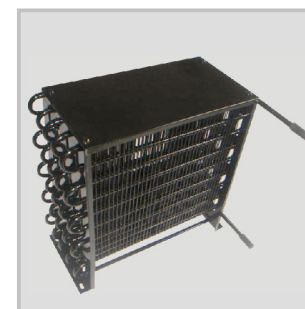

MTR-7

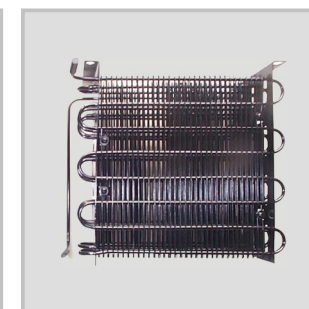

MTR-8



MTR-9



MTR-10



MTR-11

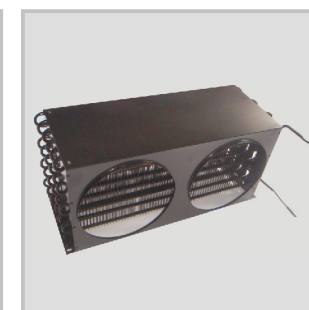

MTR-12

Parts for refrigerator, freezer, air-conditioner, water-dispenser, water-dispenser, oven etc home appliance.  
 Manufacture all kinds of models with different temperature and capillary length according to clients' requirements.



MTG-1

MTG-2

MTG-3



MTG-4

MTG-5

MTG-6



MTD-1



MTL-1



MTL-2



MTB-1



ACCESS VALVE

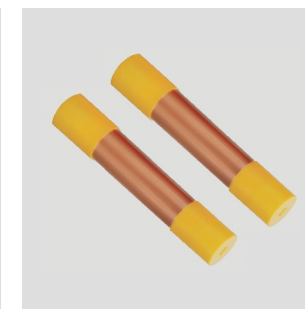

FILTER DRIER



ACCUMULATOR



A/C FILTER



COPPER SPUN



WELDED FILTER DRIER-1

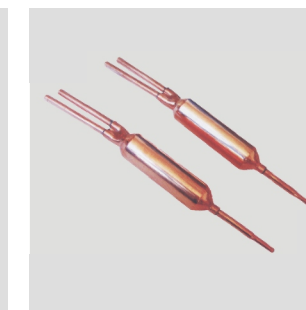

WELDED FILTER DRIER-2



NUT

Parts for refrigerator, freezer, air-conditioner, water-dispenser, water-dispenser, oven etc home appliance.  
 Manufacture all kinds of models with different temperature and capillary length according to clients' requirements.





**R134a-LBP Compressor Technology Data**

Model	Power	Disp	Oil charge	Cooling	Motor type	Cooling capacity	Rated current	C.o.p	Running power	Running current
	V/Hz	cm <sup>3</sup>	mL			W	A	W/W	W	A
<b>COPPER AND ALUMINUM COIL</b>										
QD30LW	220-240/50	3.08	180	ST	RSIR	68	0.60	0.93	108	0.77
	110-115/60					76	1.10	1.00	105	1.25
	127/60					76	1.10	1.00	108	1.38
QD36LW	220-240/50	3.68	180	ST	RSIR	86	0.74	0.93	135	0.95
	110-115/60					94	1.25	0.98	125	1.55
	127/60					94	1.20	0.98	130	1.55
<b>ALL COPPER COIL</b>										
QD30	220-240/50	3.00	180	ST	RSIR	62	0.58	0.91	104	0.75
	110-115/60					70	1.00	0.97	97	1.20
	127/60					70	1.00	0.98	105	1.35
QD36	220-240/50	3.60	180	ST	RSIR	80	0.70	0.91	130	0.90
	110-115/60					88	1.20	0.98	125	1.50
	127/60					88	1.05	0.98	128	1.50
QD43	220-240/50	4.30	200	ST	RSIR	95	0.75	1.00	145	0.95
QD51	220-240/50	5.10	200	ST	RSIR	115	0.88	1.00	156	1.05

**R600a-LBP Compressor Technology Data**

Model	Power supply	Cooling capacity	Rated power	Rated current	COP	Motor type	Running capacitor	Starting relay	Cooling type
QD43	220V-240V 50Hz	65W	52W	0.36A	1.25	RSIR	/	PTC	ST
QD52	220V-240V 50Hz	85W	65W	0.47A	1.3	RSIR	/	PTC	ST
QD65	220V-240V 50Hz	110W	82W	0.54A	1.35	RSIR	/	PTC	ST
QD75	220V-240V 50Hz	125W	90W	0.56A	1.36	RSIR	/	PTC	ST



CT-338 3-22mm MC-30 MC-32



MC-274 MC-35 MC-22 BK-0822



MC-16 MC-2010 TOOL-1 TOOL-2

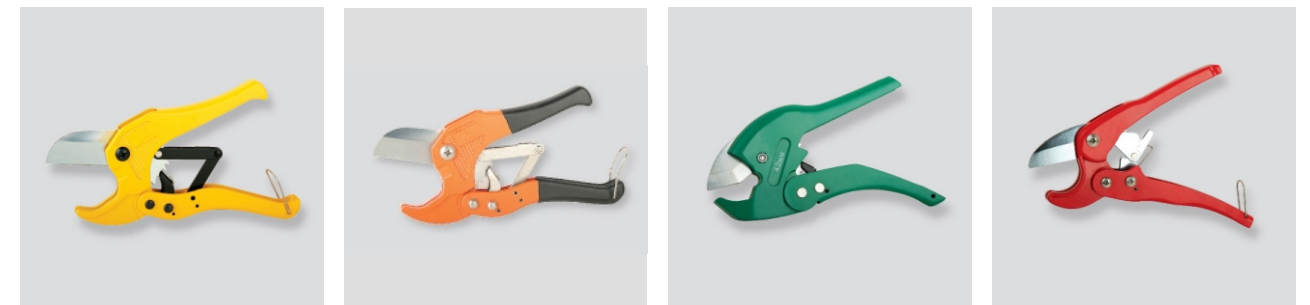

PC-801 PC-802 PC-803 PC-804



PC-805 PC-806 MC-50 MC-888

Parts for refrigerator, freezer, air-conditioner, water-dispenser, oven etc home appliance.  
 Manufacture all kinds of models with different temperature and capillary length according to clients' requirements.

Refrigeration tools and pipe tools such as: tube cutters, flaring tools, tube expanders, flaring tools for expanding tube, tube benders, pipe dies, pipe bending spring, pinch-off pliers, ratchet wrench, etc.

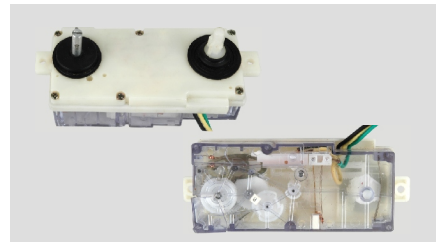

MTX-1

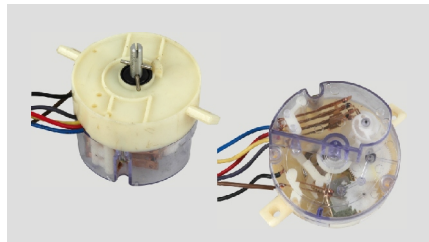

MTX-2

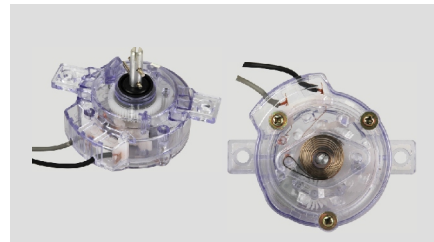

MTX-3

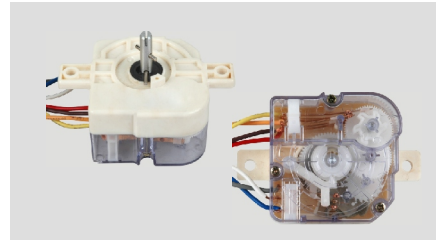

MTX-4

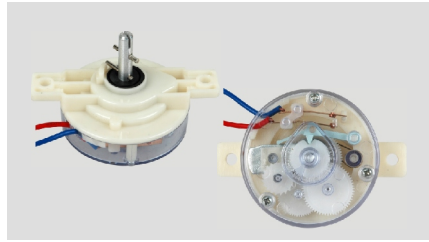

MTX-5

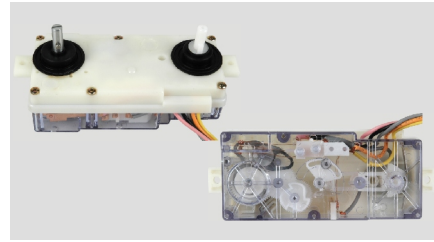

MTX-6

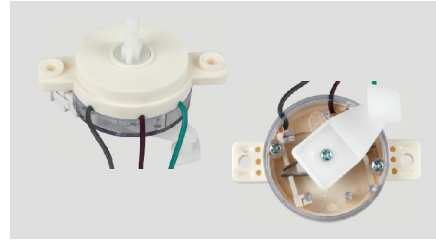

MTX-7

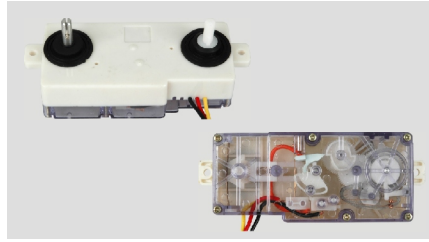

MTX-8

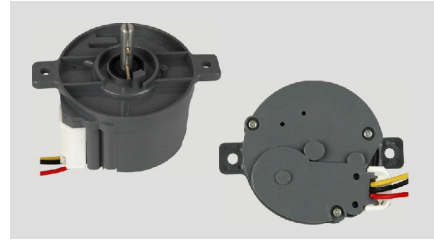

MTX-9

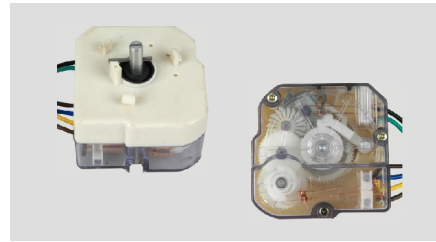

MTX-10

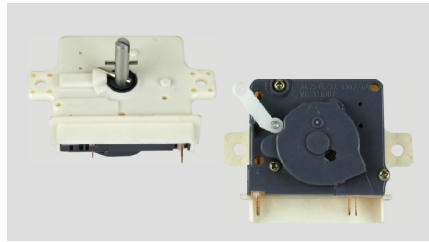

MTX-11

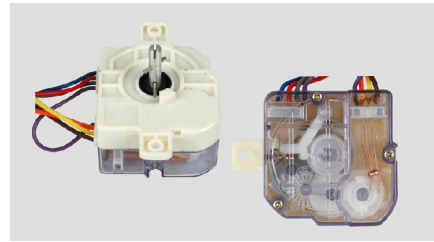

MTX-12

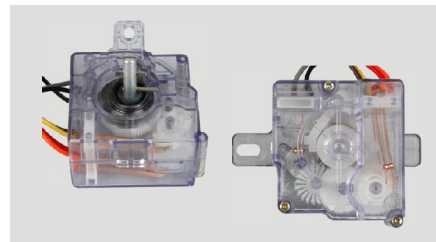

MTX-13

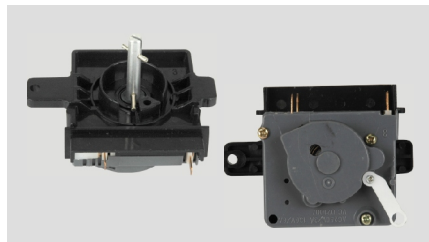

MTX-14

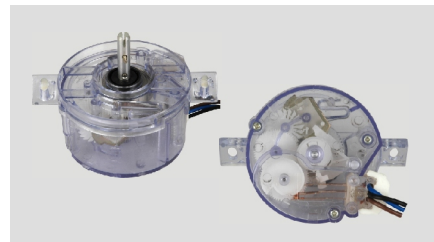

MTX-15



MTX-16



MTX-17

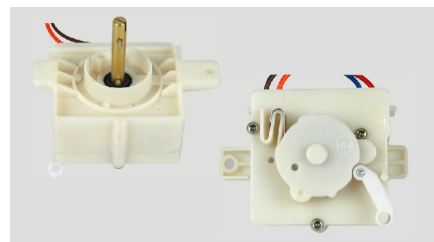

MTX-18

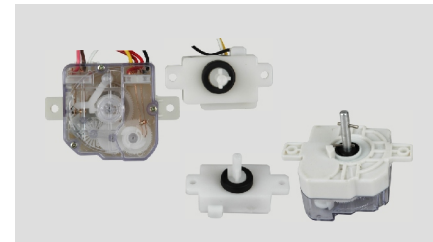

MTX-19

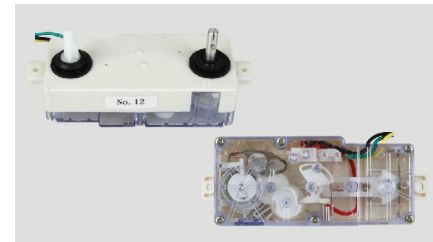

MTX-20

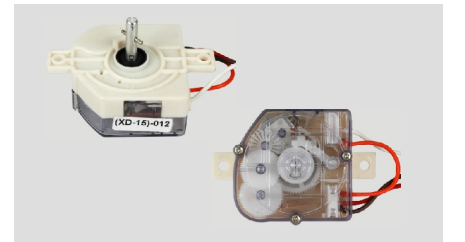

MTX-21

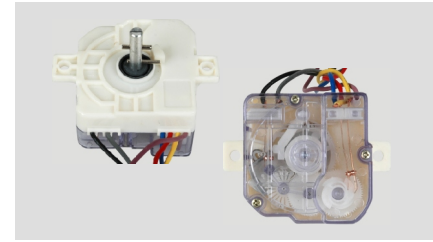

MTX-22

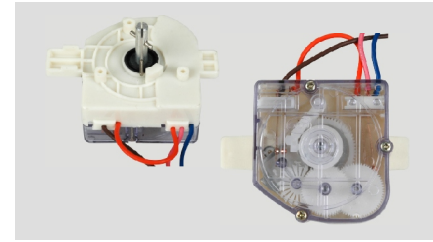

MTX-23

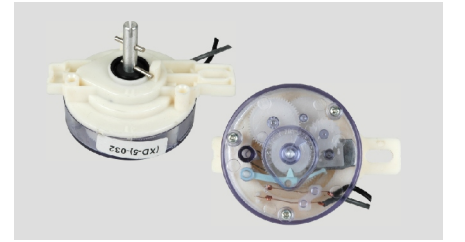

MTX-24

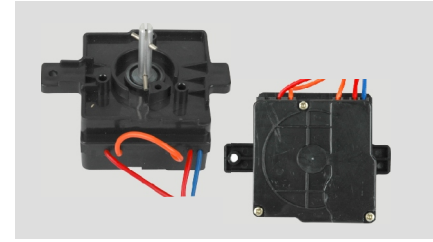

MTX-25



MTX-26

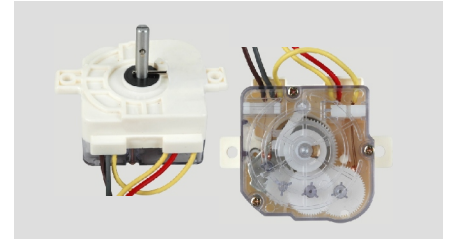

MTX-27

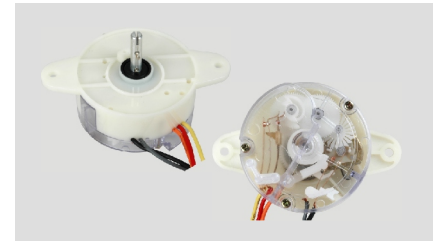

MTX-28

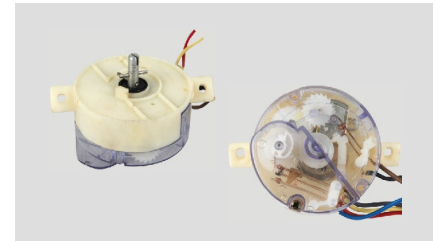

MTX-29

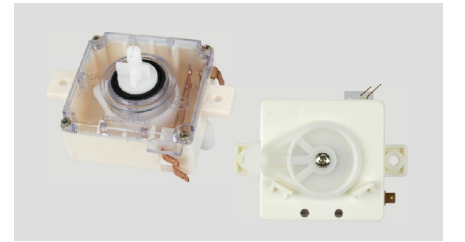

MTX-30



MTX-31

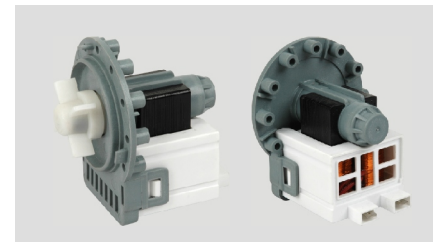

MTX-32

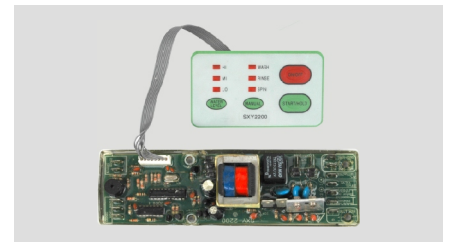

SXY2200

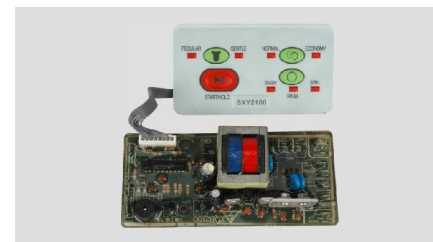

SXY2100

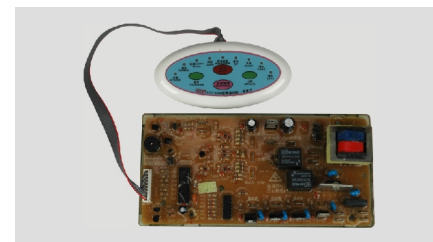

SXY2288

Parts for refrigerator, freezer, air-conditioner, water-dispenser, water-dispenser, oven etc home appliance.  
Parts for washing machine, tractor, drainage pump

Parts for refrigerator, freezer, air-conditioner, water-dispenser, water-dispenser, oven etc home appliance.  
Parts for washing machine, tractor, drainage pump



Ignition	Manual lit
Weight	93g / 105g
Dimension	100x40x180(mm)
MT201/MT812	Brass Zinc Alloy ABSPlastic Stainless steel
MT810/MT811	Brass Zinc Alloy ABSPlastic



Ignition	High-energy porcelain pressure ignition
Weight	136g
Dimension	167x50x67(mm)
Material	Brass Zinc Alloy ABSPlastic



Ignition	Manual lit
Weight	146g
Dimension	180x40x100(mm)
Material	Brass Zinc Alloy ABSPlastic

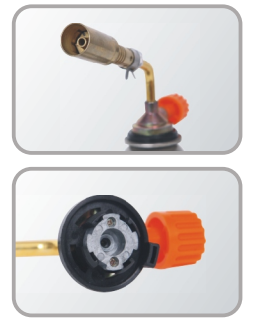

GAS TORCH



MT802	Automatic ignition
Weight	207g
Dimension	140x40x80(mm)
MT803	High-energy porcelain pressure ignition
Weight	195g
Dimension	135x40x49(mm)
Material	Brass Zinc Alloy ABSPlastic



Ignition	Manual lit
Weight	124g
Dimension	200x40x100(mm)
Material	Brass Zinc Alloy ABSPlastic



Ignition	High-energy porcelain pressure ignition
Weight	197g
Dimension	200x40x100(mm)
Material	Brass Zinc Alloy ABSPlastic



Ignition	Automatic ignition
Weight	285g
Dimension	170x40x70(mm)
Material	Brass Zinc Alloy ABSPlastic



GAS TORCH



Ignition	High-energy porcelain pressure ignition
Weight	130g / 143g
MT807	145x40x62(mm)
MT808	155x40x62(mm)
Material	Brass Zinc Alloy ABSPlastic



Ignition	High-energy porcelain pressure ignition
Weight	184g
Dimension	180x40x100(mm)
Material	Brass Zinc Alloy ABSPlastic



Ignition	High-energy porcelain pressure ignition
Weight	350g
Dimension	320x40x62(mm)
Material	Brass Zinc Alloy ABSPlastic Stainless steel



Ignition	High-energy porcelain pressure ignition
Weight	165g
Dimension	113x61x61(mm)
Material	Copper alloy, 316Stainless steel Asbestos net
Consumption quantity of steam	38g/h
Fuel	Butane steam
Power	0.48KW

Gas torch used in various industrial processor, water piping, cable joint production, welding operation, mold heating, metal jewelry, heating thawed, cattle hair removal, sheet metal processing etc. it's an indispensable tool for hiking camping barbecue.

Gas torch used in various industrial processor, water piping, cable joint production, welding operation, mold heating, metal jewelry, heating thawed, cattle hair removal, sheet metal processing etc. it's an indispensable tool for hiking camping barbecue.

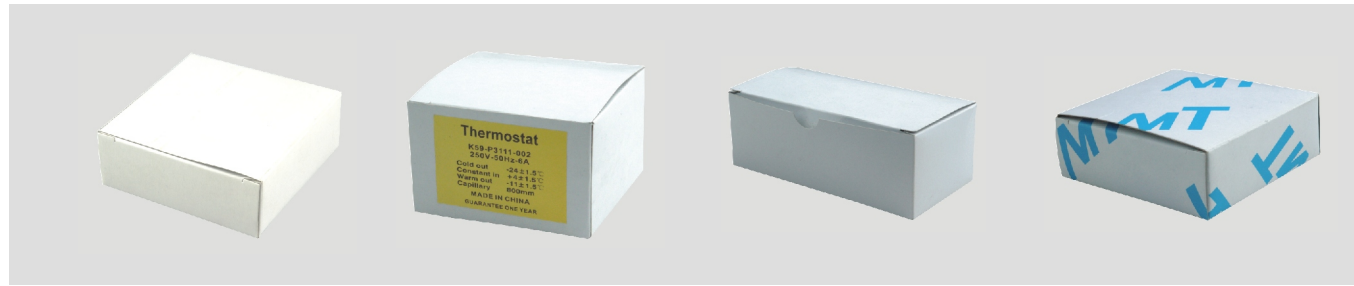

K01 K02 K03 K04

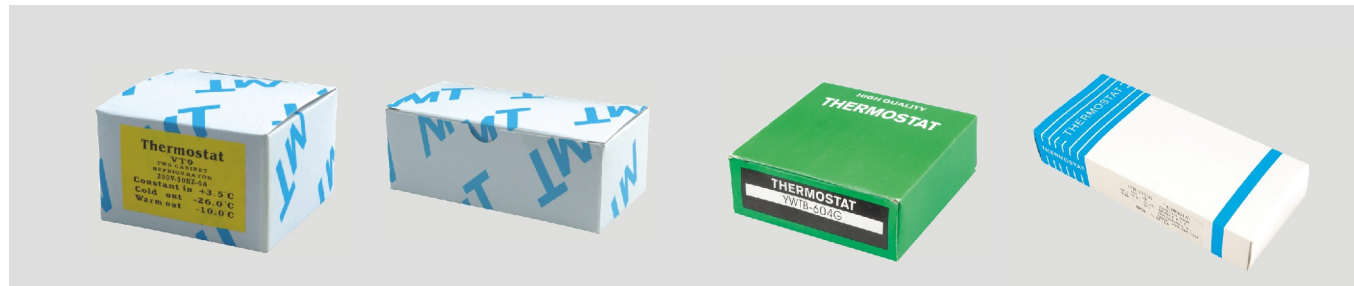

K05 K06 K07 K08

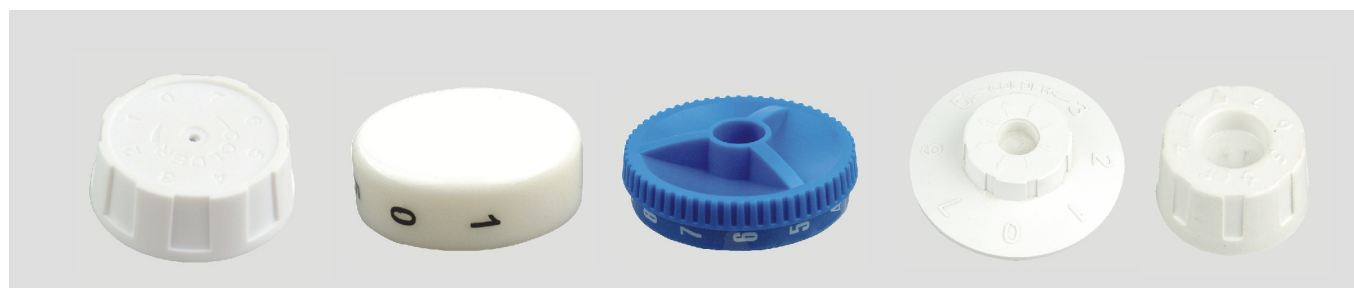

K09 K10 K11 K12 K13



N14 K15 K16 K17



K18 K19 K20 K21

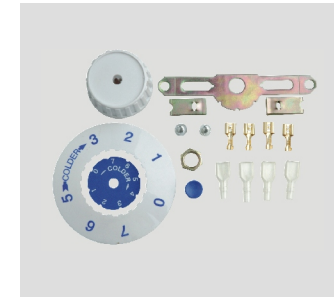

K22

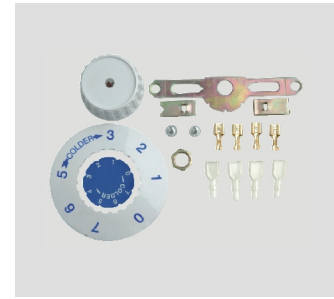

K23

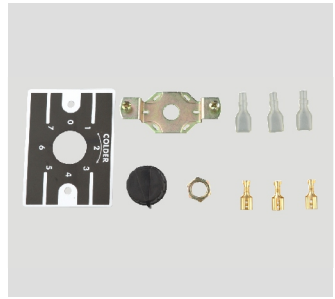

K24

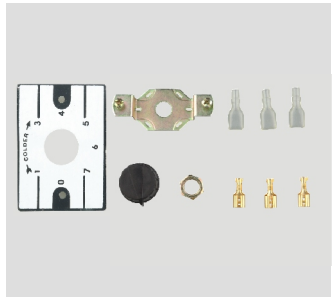

K25



K26

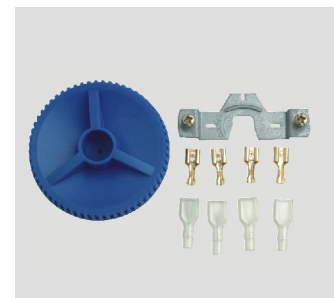

K27



K28

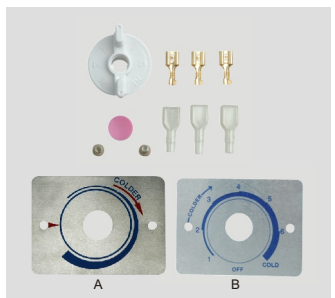

K29



K30



K31



K32



K33

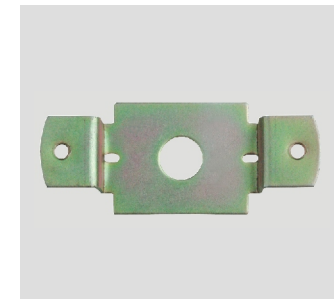

K34



K35



K36



K37

Manufacture all kinds of accessories according to clients' requirements

ACCESSORY

ACCESSORY