

Model

Designation	GTK70AT	200-240V/50Hz 1~	Sales code:	CDO00154
-------------	----------------	-------------------------	-------------	-----------------

Compressor design

Oil type	Polyolester	Refrigerant(s)	R134a
Oil viscosity	15cSt	Displacement	6,64cm ³ / 0,41cu.in
Oil quantity	156cm ³ / 5,3fl.oz	Compressors on pallet	100
Refr. charge - tech. limit			
Free gas volume comp.	1560cm ³ / 52,7fl.oz		
Weight	8,6kg / 19lbs		
Motor protection	external		
Winding resistance main	11,9Ω (at 25°C)		
Winding resistance aux	11,8Ω (at 25°C)		
Max. winding temp.	130°C / 266°F		
Max. discharge temp.	130°C / 266°F		



General - Configurations with GTK70AT

	Conf. 1	Conf. 2
Motorconfiguration	RSCR	RSIR
Power supply (nominal)	200-240V/50Hz	200-240V/50Hz
Number of phases	1	1
Voltage range	170-264V	170-264V
Approvals	VDE, EAC	VDE, EAC
Starting torque	LST	LST
Note	- / -	

Applications with GTK70AT

	Conf. 1	Conf. 2
Refrigerant	R134a	R134a
Application	LBP	LBP
System cooling	static	static
Hot gas defrost	- / -	- / -
Long interval pull down	- / -	- / -

Electrical data - Configurations with GTK70AT

	Conf. 1	Conf. 2
Starting device type	PTC	PTC
Run capacitor	4μF	- / -
Start capacitor	- / -	- / -
LRA (locked rotor amps / 4s)	7,29A	7,29A
RLA (rated load amps / 1s)		
Cut in current	14,5A	14,5A
IP class	21	21

Model

Designation	GTK70AT	200-240V/50Hz 1~	Sales code:	CDO00154
-------------	----------------	-------------------------	-------------	-----------------

Compressor dimensions

Housing	A Height	174mm / 6,85in
	B Height	167mm / 6,57in
	C Length shell	194mm / 7,64in
	D Length w. cover	238mm / 9,37in
	E Width	151mm / 5,94in

Connectors		Suction	Discharge	Process
		X	Y	Z
Diameter	[mm]	øi 6,1-6,2	øi 5,1-5,2	øo 5,92-6,08
(i:inside, o:outside)	[in]	øi 0,24-0,24	øi 0,2-0,2	øo 0,23-0,24
Material		copper	copper	copper
Horizontal angle	±2°	45°	13°	0°
Vertical angle	±2°	30°	40°	145°
Position l/h/w	[mm]	120/72/62	112/106/62	-140/136/70
	[in]	4,7/2,8/2,4	4,4/4,2/2,4	-5,5/5,4/2,8
Straight tube l.	[mm]	14	14	75
	[in]	0,5	0,5	3

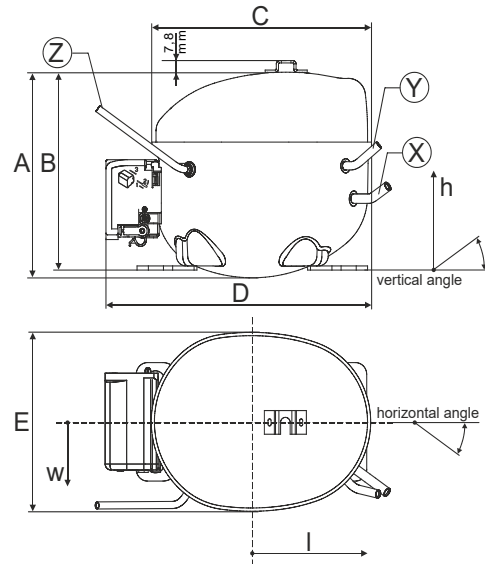

Compressor fixation

Bolt joint

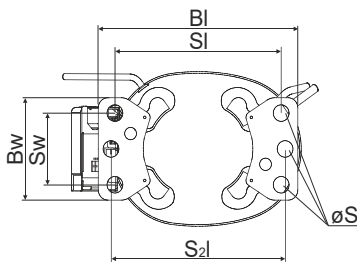

Baseplate	[mm]	[inch]
BI	204	8.03
BW	100	3.94
Small holes		
SI	170	6.7
SW	70	2.76
S2l	178	7
øS	ø 16	ø 0.63

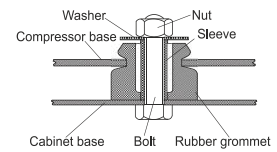

Snap-on

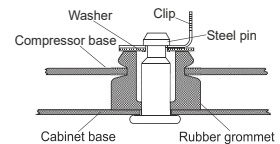

Mounting accessories

'4ZN' with rubber grommet

'4ZN' with rubber grommet and sleeve for M6

Bolt joint kit

'4ZN' with Snap on kit

order code

772N

768N

4ZN + 118-1917 (18)

776N

Application notes

Various options of housing are possible (dip-tray fixture) - please contact SECOP-Sales.

Various options of connectors are possible - please contact SECOP-Sales.

Model

Designation	GTK70AT	200-240V/50Hz	Conf. 1	Sales code:	CDO00154
-------------	----------------	----------------------	----------------	-------------	-----------------

Configuration

Motorconfiguration	RSCR
Power supply (nominal)	200-240V/50Hz 1~
Refrigerant	R134a
Application	LBP
Voltage range	170-264V
Starting torque	LST
Approvals	VDE
	EAC

Electrical accessories / wiring diagram

RSCR

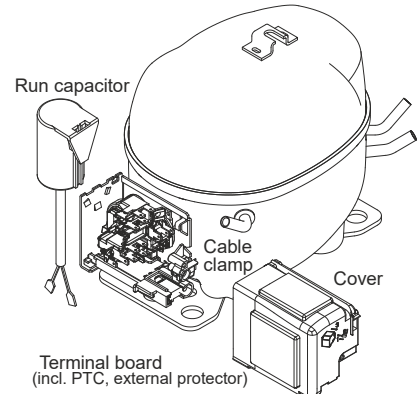

Ambient temperatures / system cooling

Ambient temperature min.:	10°C / 50°F
Ambient temperature max.:	43°C / 110°F

System cooling (n/a: outside limits)			
T ambient	LBP	MBP	HBP
32°C / 90°F	static	n/a	n/a
38°C / 100°F	static	n/a	n/a
43°C / 110°F	static	n/a	n/a

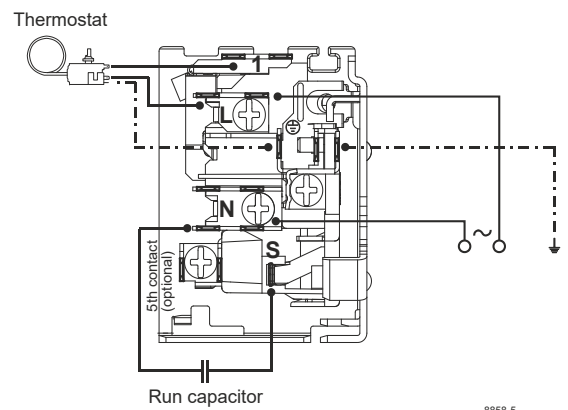

Operation pressure range

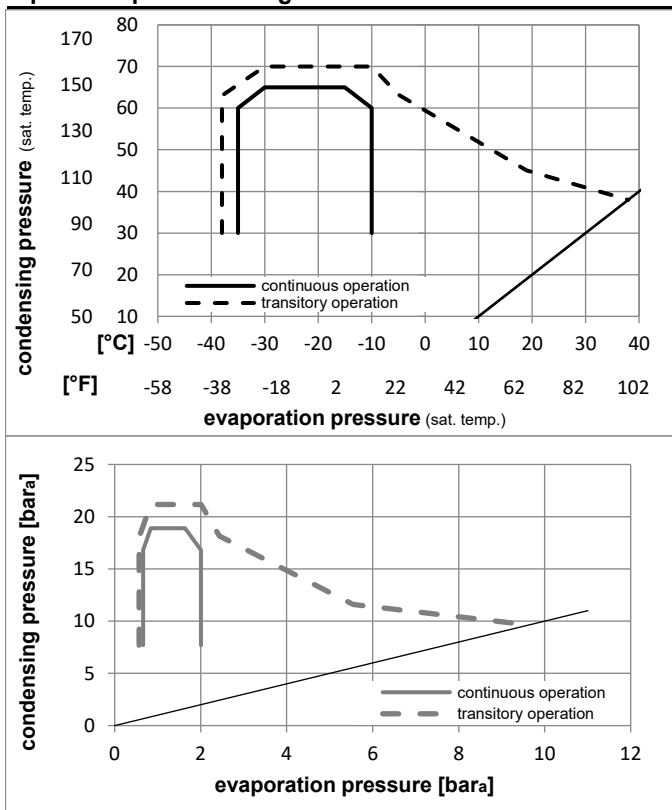

Components

- terminal board (PTC,4.8mm) ZC FP
- run capacitor (4μF, 4.8/6,3mm) cap. 4μF
- motor protector BDG AE 72 FU x AE72FUX
- cover + clamp + screws (Nr. 4ZN) 16168000

Alternative components

- terminal board (PTC,6.3mm) DC FP
- run capacitor (4μF, 4.8/6,3mm) cap. 4μF
- motor protector BDG AE 72 FU x AE72FUX
- cover + clamp + screws (Nr. 4ZN) 16168000

Model

Designation **GTK70AT 200-240V/50Hz** Conf. 1 Sales code: **CDO00154**

Optimization + standard conditions

200V/50Hz, RSCR, static, VDE, EAC

		Evaporating pressure (saturation temperature)			Condensing pressure (saturation temperature)			Return gas temp.			Liquid temp.			Cooling capacity			COP			EER			Power consumption			Current consumption			Ref. mass flow						
		pe	pc	RGT	Tliq	[W]	[Btu/h]	[kcal/h]	[W/W]	[Btu/Wh]	[kcal/Wh]	P1	I	m	[W]	[A]	[kg/h]																		
[°C]	[°F]																	ASHRAE LBP			cecomaf LBP			EN12900 LBP			ARI540 LBP			AHAM LBP			opt		
-23,3	-10	54,4	130	32,2	90	204,5	698	176,0	1,60	5,46	1,37	128,0	0,60	3,97																					
-25	-13	55	131	32	89,6	150,8	515	129,8	1,23	4,19	1,06	122,8	0,57	3,61																					
-35	-31	40	104	20	68	103,8	354	89,3	1,14	3,89	0,98	91,2	0,44	2,28																					
-23,3	-10	48,9	120	4,44	40	167,6	572	144,2	1,35	4,60	1,16	124,5	0,60	4,43																					
-23,3	-10	40,6	105	32,2	90	221,8	757	190,9	1,89	6,44	1,62	117,6	0,57	4,31																					
-35	-31	45	113	32	89,6	97,5	333	83,9	1,05	3,58	0,90	93,0	0,46	2,10																					

Performance tables

200V/50Hz, RSCR, static, VDE, EAC

		pe	Cooling capacity			COP			EER			P1	I	m
		[°C]	[°F]	[W]	[Btu/h]	[kcal/h]	[W/W]	[Btu/Wh]	[kcal/Wh]	[W]	[A]	[kg/h]		
[°C / °F]		-35	-31	97,5	333	83,9	1,05	3,58	0,90	93,0	0,46	2,10		
cond. pressure		-30	-22	134,3	459	115,6	1,28	4,39	1,11	104,5	0,51	2,90		
pc= 45/113		-25	-13	177,9	607	153,1	1,52	5,19	1,31	117,0	0,57	3,85		
return gas temp.		-23,3	-10	194,5	664	167,4	1,60	5,47	1,38	121,4	0,59	4,22		
RGT= 32/90		-20	-4	229,6	784	197,6	1,76	6,02	1,52	130,2	0,64	4,99		
liquid temp		-15	5	290,9	993	250,3	2,02	6,90	1,74	143,9	0,71	6,34		
Tliq= 45/113		-10	14	363,1	1240	312,5	2,30	7,85	1,98	158,0	0,79	7,95		
[°C / °F]		-35	-31	78,2	267	67,3	0,86	2,92	0,74	91,3	0,43	1,86		
cond. pressure		-30	-22	111,8	382	96,2	1,05	3,58	0,90	106,7	0,50	2,67		
pc= 55/131		-25	-13	150,8	515	129,8	1,23	4,19	1,06	122,8	0,57	3,61		
return gas temp		-23,3	-10	165,6	565	142,5	1,29	4,40	1,11	128,4	0,60	3,96		
RGT= 32/90		-20	-4	196,7	672	169,3	1,41	4,82	1,21	139,4	0,66	4,72		
liquid temp		-15	5	250,9	857	215,9	1,61	5,48	1,38	156,2	0,74	6,04		
Tliq= 55/131		-10	14	314,6	1075	270,8	1,82	6,20	1,56	173,2	0,83	7,61		

Model

Designation	GTK70AT	200-240V/50Hz	Conf. 2	Sales code:	CDO00154
-------------	----------------	----------------------	----------------	-------------	-----------------

Configuration

Motorconfiguration	RSIR
Power supply (nominal)	200-240V/50Hz 1~
Refrigerant	R134a
Application	LBP
Voltage range	170-264V
Starting torque	LST
Approvals	VDE
	EAC

Electrical accessories / wiring diagram

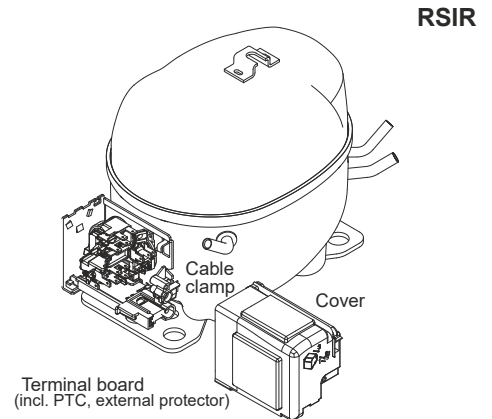

Ambient temperatures / system cooling

Ambient temperature min.:	10°C / 50°F
Ambient temperature max.:	43°C / 110°F

System cooling (n/a: outside limits)			
T ambient	LBP	MBP	HBP
32°C / 90°F	static	n/a	n/a
38°C / 100°F	static	n/a	n/a
43°C / 110°F	static	n/a	n/a

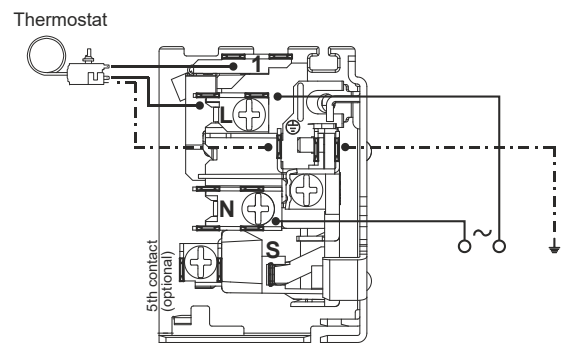

8858-6

Operation pressure range

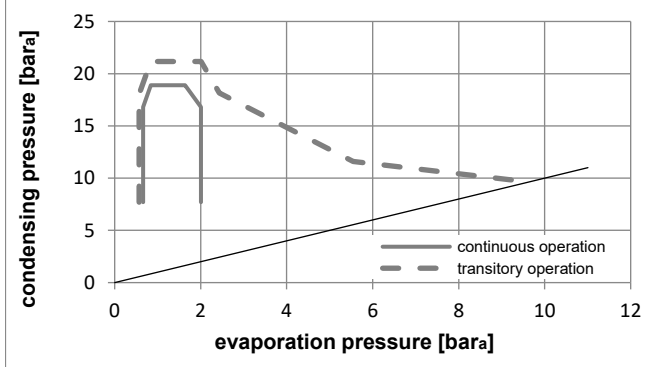
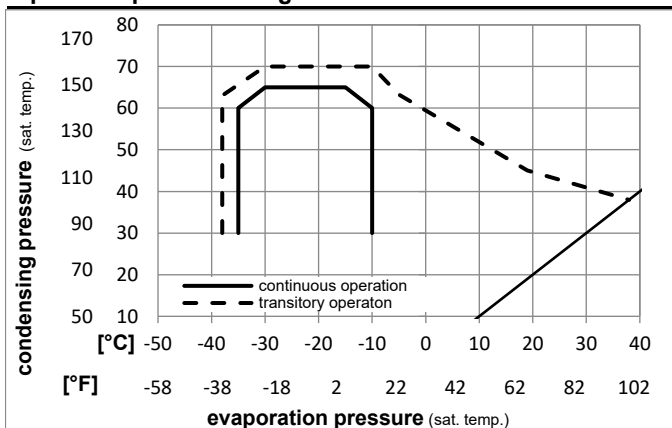

Components

- . terminal board (PTC,4.8mm) ZC FP
- . motor protector BDG AE 72 FU x AE72FUX
- . cover + clamp + screws (Nr. 4ZN) 16168000

Alternative components

- . terminal board (PTC,6.3mm) DC FP
- . motor protector BDG AE 72 FU x AE72FUX
- . cover + clamp + screws (Nr. 4ZN) 16168000

Model

Designation **GTK70AT 200-240V/50Hz** Conf. **2** Sales code: **CDO00154**

Optimization + standard conditions

200V/50Hz, RSIR, static, VDE, EAC

		Evaporating pressure (saturation temperature)				Condensing pressure (saturation temperature)						Power consumption			
		Return gas temp.		Liquid temp.		Cooling capacity				COP	EER	P1	Current consumption		Ref. mass flow
		pe	pc	RGT	Tliq	[W]	[Btu/h]	[kcal/h]	[W/W]	[Btu/Wh]	[kcal/Wh]	[W]	I	m	
[°C]	[°F]												[A]	[kg/h]	
-23,3	-10	54,4	130	32,2	90	204,6	699	176,1	1,52	5,18	1,31	134,7	0,63	3,97	ASHRAE LBP
-25	-13	55	131	32	89,6	150,8	515	129,8	1,17	3,99	1,00	129,2	0,60	3,61	cecomaf LBP
-35	-31	40	104	20	68	103,8	355	89,4	1,09	3,71	0,94	95,5	0,45	2,28	EN12900 LBP
-23,3	-10	48,9	120	4,44	40	167,6	573	144,3	1,28	4,37	1,10	131,0	0,62	4,43	ARI540 LBP
-23,3	-10	40,6	105	32,2	90	221,8	758	190,9	1,79	6,12	1,54	123,9	0,57	4,31	AHAM LBP
-35	-31	45	113	32	89,6	97,5	333	83,9	1,00	3,42	0,86	97,4	0,45	2,10	opt

Performance tables

200V/50Hz, RSIR, static, VDE, EAC

	pe	Cooling capacity			COP	EER	P1	I	m		
	[°C]	[°F]	[W]	[Btu/h]	[kcal/h]	[W/W]	[Btu/Wh]	[kcal/Wh]	[W]	[A]	[kg/h]
[°C / °F]	-35	-31	97,5	333	83,9	1,00	3,42	0,86	97,4	0,45	2,10
cond. pressure	-30	-22	134,3	459	115,6	1,22	4,18	1,05	109,8	0,50	2,90
pc= 45/113	-25	-13	177,9	608	153,1	1,44	4,93	1,24	123,1	0,57	3,85
return gas temp.	-23,3	-10	194,5	664	167,4	1,52	5,20	1,31	127,8	0,59	4,22
RGT= 32/90	-20	-4	229,6	784	197,6	1,67	5,72	1,44	137,1	0,65	4,99
liquid temp	-15	5	290,9	993	250,3	1,92	6,55	1,65	151,7	0,73	6,34
Tliq= 45/113	-10	14	363,1	1240	312,5	2,18	7,45	1,88	166,5	0,82	7,95
[°C / °F]	-35	-31	78,2	267	67,3	0,82	2,80	0,70	95,5	0,45	1,86
cond. pressure	-30	-22	111,8	382	96,2	1,00	3,41	0,86	112,0	0,52	2,67
pc= 55/131	-25	-13	150,8	515	129,8	1,17	3,99	1,00	129,2	0,60	3,61
return gas temp	-23,3	-10	165,6	566	142,5	1,23	4,18	1,05	135,1	0,64	3,96
RGT= 32/90	-20	-4	196,7	672	169,3	1,34	4,58	1,15	146,8	0,70	4,72
liquid temp	-15	5	250,8	857	215,9	1,52	5,20	1,31	164,7	0,80	6,04
Tliq= 55/131	-10	14	314,6	1074	270,7	1,72	5,88	1,48	182,6	0,90	7,61