

## Compressor Technical Data

Model **EGM90AZ** Code **552090380116**

**LBP**

### General Data

|                                |                    |
|--------------------------------|--------------------|
| Refrigerant:                   | R134a              |
| Application:                   | LBP                |
| Evaporating Temperature Range: | -30°C to -10°C     |
| Voltage/Frequency:             | 220-240V 50Hz 1~   |
| Compressor Cooling:            | Static             |
| Expansion Device:              | Capillary Tube     |
| Packaging Quantity:            | Multi - 96:120 pcs |
| Approvals:                     | CE-VDE-GOST        |



### Mechanical Data

|                         |                     |
|-------------------------|---------------------|
| Oil Charge:             | 300 cm <sup>3</sup> |
| Oil Type Configuration: | ester               |
| Oil Type Viscosity:     | 19 cSt              |
| Weight:                 | 10 kg               |

### Electrical Data

|                                 |                |
|---------------------------------|----------------|
| Motor Type:                     | RSIR / RSCR*   |
| Voltage working range at 50 Hz: | 187-264V       |
| Maximum Motor Temperature:      | 130°C          |
| Locked Rotor Current:           | 14.46 / 9.86 A |
| Start Winding Resistance:       | 23.40Ω at 25°C |
| Run Winding Resistance:         | 8.08 Ω at 25°C |
| Phase :                         | 1 ph           |

### External Characteristics

|                     |        |
|---------------------|--------|
| Internal Diameter   | (mm)   |
| Suction Connector   | 6.5    |
| Discharge Connector | 4.9    |
| Process Connector   | 6.5    |
| Material            | Copper |

### Electrical Components

|                   |          |
|-------------------|----------|
| Component Type    |          |
| Starting Device:  | PTC 14Ω  |
| Motor Protection: | T0490/xx |

MCMC compressors reserves the right to change the data without prior notice

10th of Ramadan City - (Cairo) Egypt  
 Industrial Zone A-2  
 P.o Box : 1001 ( 10th of Ramadan )  
 Tel. : 0554 - 413322 ( 10 lines )  
 Fax. : 0554 - 413161 - 413029  
 Web site : <http://www.zmcegypt.com>



Circuit Diagram for Mod.90 Terminal Board

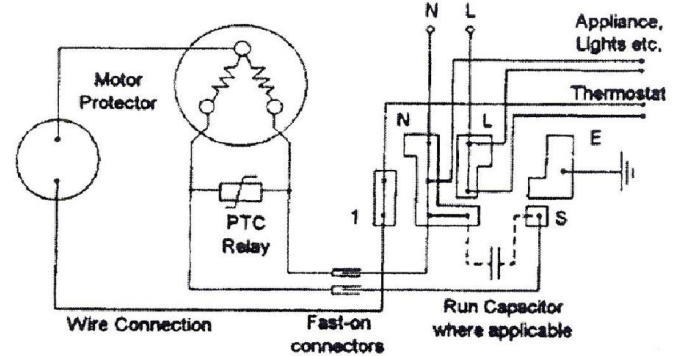

Circuit Diagram for U.H. Terminal Board

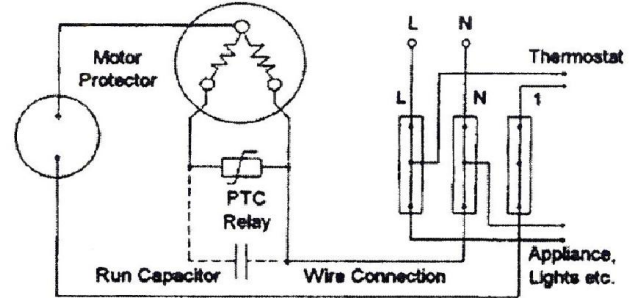

Recommended Transport  
Positions when fitted into  
appliances

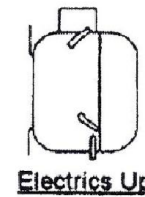
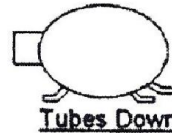
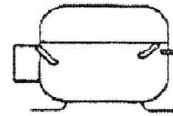

العاشر من رمضان  
 المنطقة الصناعية أ - ٢  
 ص.ب : ١٠٠١ العاشر من رمضان  
 تليفون : ٤١٣٣٢٢ - ٠٥٥٤ ( ١٠ خطوط )  
 فاكس : ٤١٣١٦١ - ٤١٣٠٢٩ ( ٠٥٥٤ )

**PERFORMANCE CURVE DATA :**

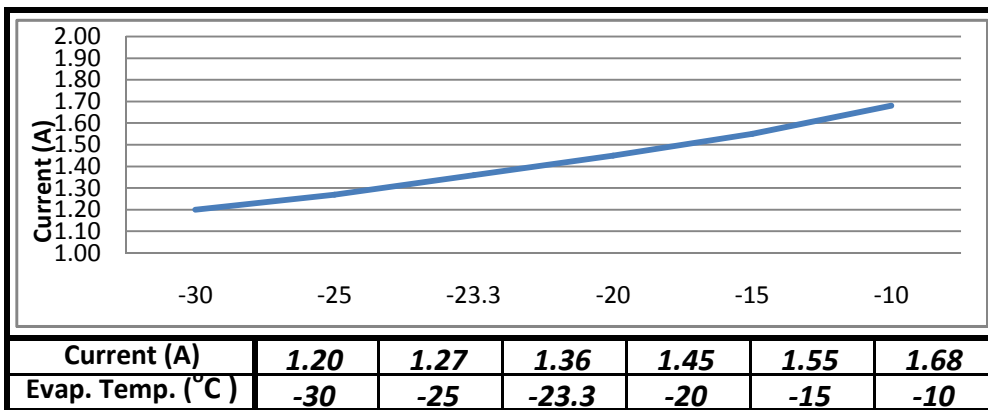
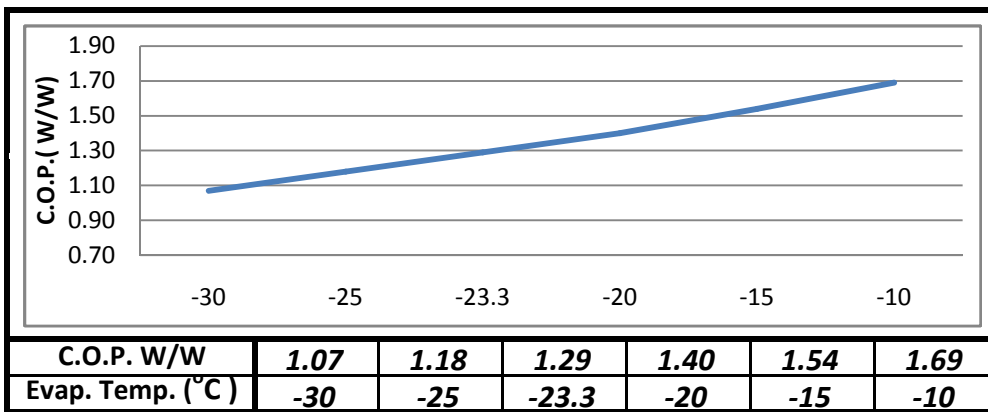
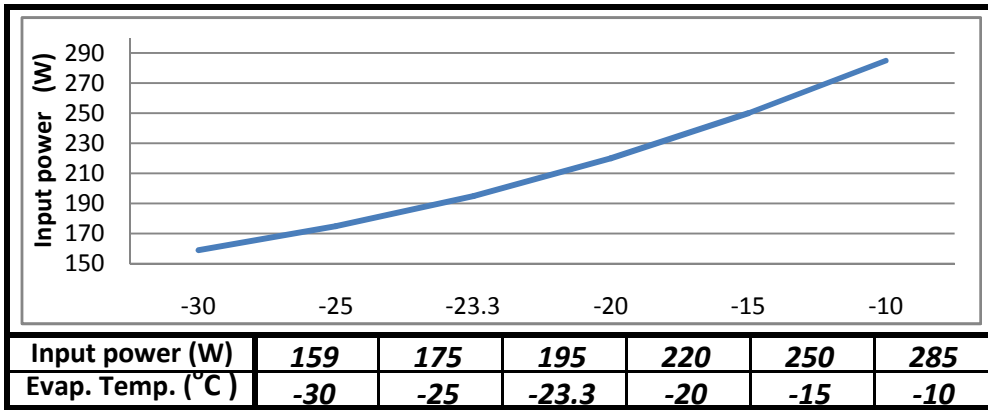
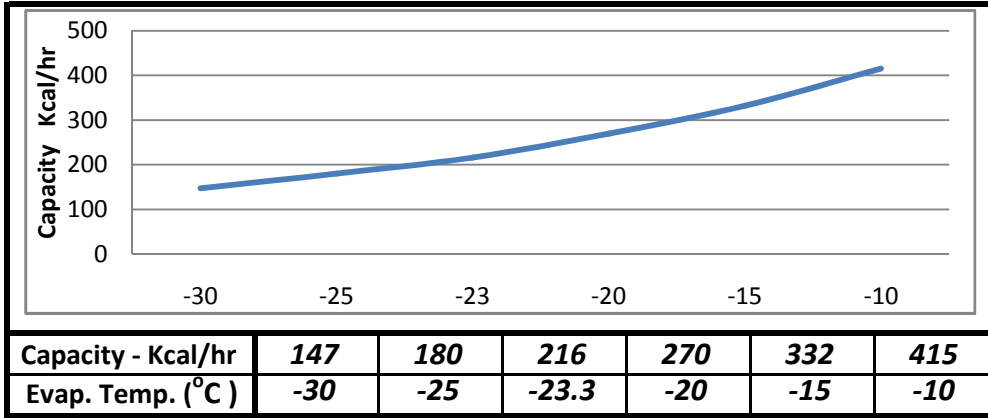

Test Condition: Ashrae, Static, Return Gas 32°C Subcooling OK, Evaporating: 23.3°C, Condensing: 55°C , Ambient: 32°C

10th of Ramadan City - (Cairo) Egypt  
 Industrial Zone A-2  
 P.o Box : 1001 ( 10th of Ramadan )  
 Tel. : 0554 - 413322 ( 10 lines )  
 Fax. : 0554 - 413161 - 413029  
 Web site : <http://www.zmcegypt.com>



العاشر من رمضان  
 المنطقة الصناعية أ - ٢  
 ص.ب : ١٠٠١ العاشر من رمضان  
 تليفون : ٤١٣٣٢٢ - ٠٥٥٤ ( ١٠ خطوط )  
 فاكس : ٤١٣١٦١ - ٤١٣٠٢٩ ( ٠٥٥٤ )

| GM, GN and GL models                                     |                        | HL and HP models |           |
|--|------------------------|------------------|-----------|
|  |                        |                  |           |
| Standard dimensions for mounting hole centres: 170x70 mm |                        |                  |           |
| <i>Special feet</i>                                      |                        |                  |           |
| Models   | Distance between holes | Holes diameter   |           |
| GM/GN/HL/HP/GP   | 165 x 101.6            | 4 x 19           |           |
|  | 170 x 70               | 6 x 165          |           |
| Tube internal diameter "GM", "GN", "GL", "HL"            |                        | "HP" and "GP"    |           |
| Material   | Suction                | Service          | Discharge |
| Copper steel / copper                                    | 6.1                    | 6.1              | 4.9       |
| Copper   | 6.1                    | 6.1              | 5.1       |
| Copper   | 6.5                    | 6.5              | 4.9       |
| Copper   | 8.1                    | 8.1              | 6.5       |

### Mounting accessories

| Standard |  | Standard |  |
|----------|--|----------|--|
|          |  |          |  |

10th of Ramadan City - (Cairo) Egypt  
 Industrial Zone A-2  
 P.o Box : 1001 ( 10th of Ramadan )  
 Tel. : 0554 - 413322 ( 10 lines )  
 Fax. : 0554 - 413161 - 413029  
 Web site : <http://www.zmcegypt.com>



العاشر من رمضان  
 المنطقة الصناعية أ - ٢  
 ص.ب : ١٠٠١ العاشر من رمضان  
 تليفون : ٤١٣٣٢٢ - ٠٥٥٤ ( ١٠ خطوط )  
 فاكس : ٤١٣١٦١ - ٤١٣٠٢٩ ( ٠٥٥٤ )

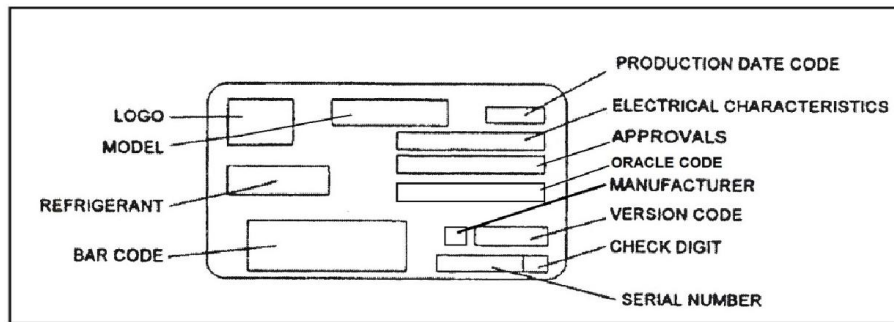
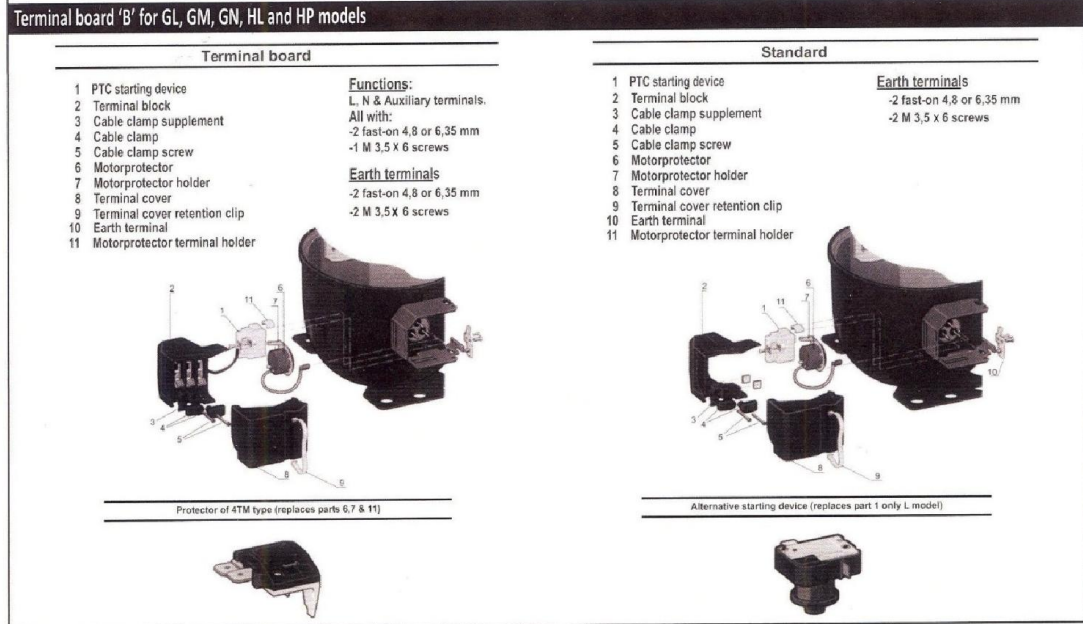
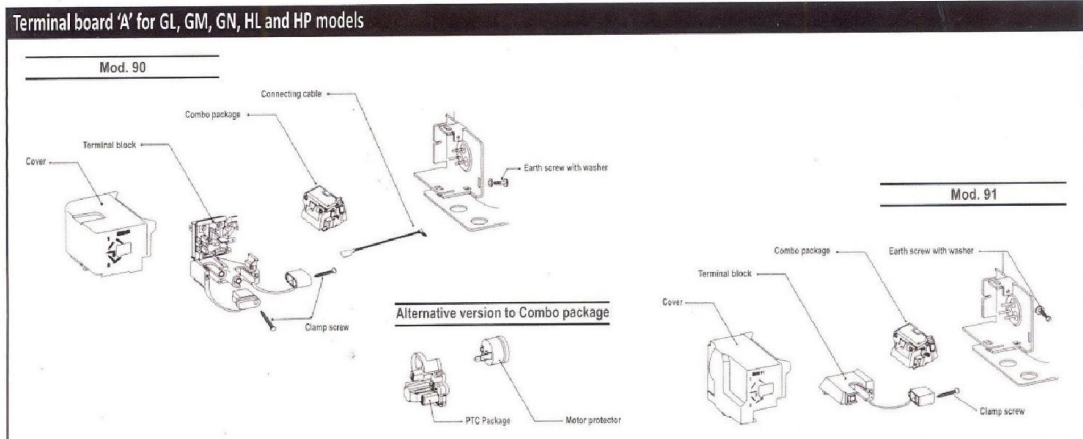

10th of Ramadan City - (Cairo) Egypt  
 Industrial Zone A-2  
 P.o Box : 1001 ( 10th of Ramadan )  
 Tel. : 0554 - 413322 ( 10 lines )  
 Fax. : 0554 - 413161 - 413029  
 Web site : <http://www.zmcegypt.com>



العاشر من رمضان  
 المنطقة الصناعية أ - ٢  
 ص.ب : ١٠٠١ العاشر من رمضان  
 تليفون : ٠٥٥٤ - ٤١٣٣٢٢ ( ١٠ خطوط )  
 فاكس : ٠٥٥٤ - ٤١٣١٦١ - ٤١٣٠٢٩