

Compresseur, réfrigération EMBRACO, FF7.5HBK1, FF7.5HBK, R12, 1/5++ HP, (1/4hp) R134a, 158f/h, Ffc60bk, Kiriazi Egypt k 330, 330l

Category: compressor

written by www.mbsm.pro | 31 December 2020



Conçu pour faire circuler le réfrigérant R12. Ce compresseur remplace un compresseur usé ou cassé pour maintenir votre unité en parfait état et minimiser les temps d'arrêt. 1/5 + ch. 115V.

Ancien numéro de pièce FF7.5BK

Tecumseh #

AEA3425AXA

Copeland #

ARE25C3-IAA

Compresseur de réfrigération Embraco Universal FF7.5HBK . Contre-pression faible, moyenne et élevée. 1/5 + HP nominal du moteur. À utiliser avec les réfrigérateurs, les machines à glaçons, les armoires pour produits surgelés, les vitrines de produits surgelés, les vitrines, etc.

Remplace Copeland ARE25C3E-IAA, Embraco EMI60HER, FF6HBK, EME60HER, EM65HHC, EM65HNR et EGY70HLP et Tecumseh AEA1360YXA et AEA3425YXA.

Moteur: Résistive Start Inductive Run (RSIR)

Températures d'évaporation: -10 ° F à 45 ° F

Spécifications du produit

Capacité BTU HBP:	2760
Capacité BTU LBP & amp; MBP:	630
Puissance (HP):	1/5 +
Ampères à rotor bloqué (LRA):	25,0
Type de moteur:	RSIR

Niveau de compétence:

Couple de démarrage:	Ordinaire
Volts (V):	120

Embraco FF 7.5BK

3065

THERMALLY PROTECTED	
10 LRA	
R12	1 H

220-240V ~
50Hz

JOINVILLE - SC

MADE IN BRAZIL



513203969



03109346



Private Picture Copyright : WWW.MBSM.PRO



Private Picture Copyright : WWW.MBSM.PRO



AI
honor 10 Lite

Private Picture Copyright : WWW.MBSM.PRO

Mbsm_dot_pro_private_PDF_aftermarket-line-of-products-complete-en-jan-2020-4Télécharger

Mbsm_dot_pro_private_PDF_Ff75bkTélécharger

Compressor, ZMC, EGM99AZ, 1/4 Hp,
1PH, R134a, LBP, 220-240V 50Hz

Category: compressor

written by www.mbsm.pro | 31 December 2020





Private Picture Copyright: WWW.MBSM.PRO

General Data

R134a	:Refrigerant
LBP	:Application
30°C to -10°C-	:Evaporating Temperature Range
220/240V/50 HZ	:Voltage/Frequency
Static	:Compressor Cooling
Capillary Tube	:Expansion Device
Multi - 96:120 pcs	:Packaging Quantity
CE-VDE-GOST	:Approvals



Private Picture Copyright: WWW.MBSM.PRO

Mechanical Data

cm ³ 350	:Oil Charge
ester	:Oil Type Configuration
cSt 19	:Oil Type Viscosity
kg 10.25	:Weight

Electrical Data

*RSIR / RSCR	:Motor Type
187-264V	:Voltage working range at 50 Hz
130°C	:Maximum Motor Temperature
A 10.19 / 14.49	:Locked Rotor Current
25.08Ω at 25°C	:Start Winding Resistance
Ω at 25°C 7.33	:Run Winding Resistance
ph 1	:Phase



Private Picture Copyright : WWW.MBSM.PRO

External Characteristics

(mm)	Internal Diameter
6.5	Suction Connector
4.9	Discharge Connector
6.5	Process Connector
Copper	Material

Electrical Components

PTC 14Ω	:Starting Device
T0137/xx	:Motor Protection



Private Picture Copyright : WWW.MBSM.PRO

Circuit Diagram for Mod 90 Terminal Board

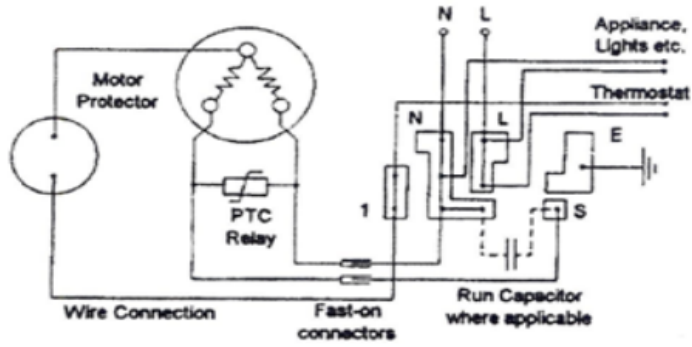

Circuit Diagram for U.H. Terminal Board

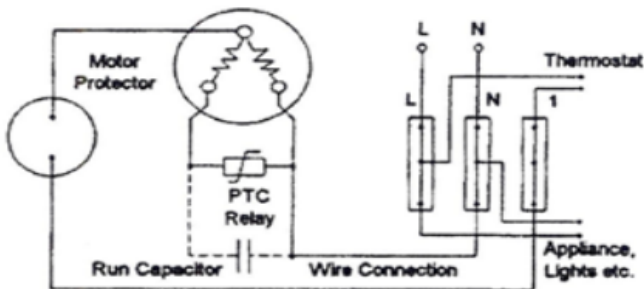

Private Picture Copyright : WWW.MBSM.PRO

PERFORMANCE CURVE DATA:

EGM99AZ

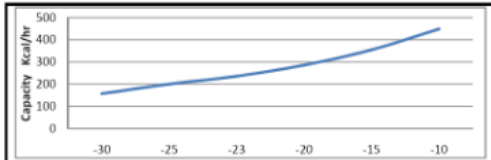

Capacity - Kcal/hr	157	200	236	286	355	449
Evap. Temp. (°C)	-30	-25	-23.3	-20	-15	-10

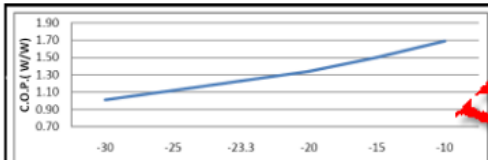

C.O.P. W/W	1.01	1.12	1.23	1.34	1.50	1.69
Evap. Temp. (°C)	-30	-25	-23.3	-20	-15	-10

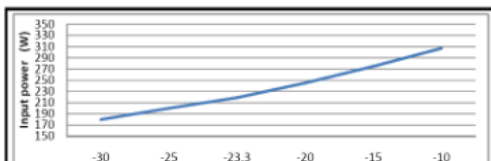

Input power (W)	180	200	219	245	275	307
Evap. Temp. (°C)	-30	-25	-23.3	-20	-15	-10

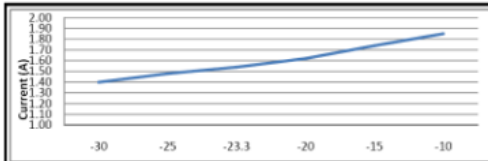

Current (A)	1.40	1.48	1.54	1.62	1.74	1.85
Evap. Temp. (°C)	-30	-25	-23.3	-20	-15	-10

Test Condition: Astrea, Static, Return Gas 32°C Subcooling OK, Evaporating: 23.3°C, Condensing: 55°C, Ambient: 32°C

Private Picture Copyright : WWW.MBSM.PRO



ZMC
R 134 a
EGM99AZ

Compresseur, Secop, GTK80AT, 232W, R134, LBP, 1/4 HP, RSIR, 791 BTU

Category: compressor

written by www.mbsm.pro | 31 December 2020



Le compresseur Secop hermétique GTK80AT RSIR est silencieux et dispose d'une large gamme de fonctionnalités utiles. Convient pour une utilisation dans les systèmes de réfrigération domestiques et industriels. Il a une taille compacte

et des performances élevées, une faible consommation d'énergie et une haute qualité. Adapté aux chutes de tension et résiste à de fortes charges.

Caractéristiques du compresseur Secop GTK80AT

- Fiabilité combinée à une longue durée de vie
- Faible niveau de bruit
- Protection thermique interne du moteur
- Tubes d'acier
- Ressort sur tube à décharge interne

2014 **GTK80AT**

SECOP

MADE IN AUSTRIA

200-240V~50Hz

R134a



□ SUCTION ▶

4 605 0087938 2



EAC **CE**



Compresseur	Réfrigération Q, W	Rendez-vous	Source de courant	Coût, frotter	Disponibilité
 GL99AAb R134a (LBP)	237	Basse température	1 phase / 220 V / 50 Hz	n / a	0 pièces
 GL90AAa R134a (LBP)	223	Basse température	1 phase / 220 V / 50 Hz	4 324,52	5 pièces et plus
 GL90AAb R134a (LBP)	223	Basse température	1 phase / 220 V / 50 Hz	n / a	0 pièces
 GL90ANa	221	Basse température	1 phase / 220 V / 50 Hz	n / a	0 pièces
 GL90ANb	221	Basse température	1 phase / 220 V / 50 Hz	n / a	0 pièces
 GL90ANc	221	Basse température	1 phase / 220 V / 50 Hz	n / a	0 pièces
 GL99AAa R134a (LBP)	237	Basse température	1 phase / 220 V / 50 Hz	4 384,85	5 pièces et plus
 GLY80AAa	221	Basse température	1 phase / 220 V / 50 Hz	n / a	0 pièces
 GLY80AAb	221	Basse température	1 phase / 220 V / 50 Hz	n / a	0 pièces
 HYE81Ya	235	Basse température	1 phase / 220 V / 50 Hz	3 021,23	5 pièces et plus
 NEK1118Z R-134a / LBP / 8,39 cm3	224	Basse température	1 phase / 220 V / 50 Hz	5 917,97	5 pièces et plus
 NEK2117GK	235	Basse température	1 phase / 220 V / 50 Hz	n / a	0 pièces
 NL9F	212	Basse température	1 phase / 220 V / 50 Hz	n / a	0 pièces
 NL9FT (LBP)	220	Basse température	1 phase / 220 V / 50 Hz	5 950,37	5 pièces et plus
 GTK80AT (R134a)	232	Basse température	1 phase / 220 V / 50 Hz	3 650,38	5 pièces et plus
 AE2410Y_FZ1A R134a	240	Basse température	1 phase / 220 V / 50 Hz	n / a	0 pièces
 AE1390Y_FZ1A	214	Basse température	1 phase / 220 V / 50 Hz	n / a	0 pièces



Model

Designation **GTK80AT** 200-240V/50Hz 1~ Sales code: **CDO00155**

Compressor design

Oil type	Polyolester	Refrigerant(s)	R134a
Oil viscosity	15cSt	Displacement	7,7cm ³ / 0,47cu.in
Oil quantity	156cm ³ / 5,3fl.oz	Compressors on pallet	100
Refr. charge - tech. limit			
Free gas volume comp.	1560cm ³ / 52,7fl.oz		
Weight	9,1kg / 20,1lbs		
Motor protection	external		
Winding resistance main	10,4Ω (at 25°C)		
Winding resistance aux	20,5Ω (at 25°C)		
Max. winding temp.	130°C / 266°F		
Max. discharge temp.	130°C / 266°F		

**General - Configurations with GTK80AT**

	Conf. 1	Conf. 2
Motorconfiguration	RSCR	RSIR
Power supply (nominal)	200-240V/50Hz	200-240V/50Hz
Number of phases	1	1
Voltage range	170-264V	170-264V
Approvals	VDE, EAC	VDE, EAC
Starting torque	LST	LST
Note	- / -	

Applications with GTK80AT

	Conf. 1	Conf. 2
Refrigerant	R134a	R134a
Application	LBP	LBP
System cooling	static	static
Hot gas defrost	- / -	- / -
Long interval pull down	- / -	- / -

Electrical data - Configurations with GTK80AT

	Conf. 1	Conf. 2
Starting device type	PTC	PTC
Run capacitor	4μF	- / -
Start capacitor	- / -	- / -
LRA (locked rotor amps / 4s)	8,25A	8,25A
RLA (rated load amps / 1s)		
Cut in current	15,5A	15,5A
IP class	21	21

ООО «Промхолд-Ровно»
 (098) 111-73-73
 (099) 111-61-63
 (063) 111-64-63

Model

Designation **GTK80AT 200-240V/50Hz** Conf. 1 Sales code: **CDO00155**

Optimization + standard conditions

200V/50Hz, RSCR, static, VDE, EAC

	Evaporating pressure (saturation temperature)				Condensing pressure (saturation temperature)			Return gas temp.	Liquid temp.	Cooling capacity	COP	EER	Power consumption			ASHRAE LBP
	pe	pc	RGT	Tliq	[W]	[Btu/h]	[kcal/h]						P1	I	Ref. mass flow	
	[°C]	[°C]	[°C]	[°C]	[W]	[Btu/h]	[kcal/h]	[W/W]	[Btu/Wh]	[kcal/Wh]	[W]	[A]	[kg/h]			
	-23,3	54,4	32,2	32,2	231,5	791	199,2	1,60	5,46	1,38	144,8	0,66	4,49	ASHRAE LBP		
	[°F]															
	-10	130	90	90												
	-25	55	32	55	170,5	582	146,7	1,23	4,19	1,06	138,8	0,63	4,08	cecomaf LBP		
	[°F]															
	-13	131	89,6	131												
	-35	40	20	40	121,3	414	104,4	1,16	3,96	1,00	104,7	0,48	2,66	EN12900 LBP		
	[°F]															
	-31	104	68	104												
	-23,3	48,9	4,44	48,9	190,7	651	164,1	1,35	4,62	1,16	141,1	0,64	5,04	ARI540 LBP		
	[°F]															
	-10	120	40	120												
	-23,3	40,6	32,2	32,2	253,4	865	218,0	1,87	6,39	1,61	135,4	0,66	4,92	AHAM LBP		
	[°F]															
	-10	105	90	90												
	-35	45	32	45	112,9	386	97,2	1,06	3,62	0,91	106,4	0,46	2,44	opt		
	[°F]															
	-31	113	89,6	113												

Performance tables

200V/50Hz, RSCR, static, VDE, EAC

	pe	Cooling capacity			COP	EER	P1	I	m		
		[°C]	[°F]	[W]						[Btu/h]	[kcal/h]
[°C / °F]	-35	-31	112,9	386	97,2	1,06	3,62	0,91	106,4	0,46	2,44
cond. pressure	-30	-22	154,5	528	133,0	1,31	4,47	1,13	118,2	0,54	3,34
pc= 45/113	-25	-13	203,5	695	175,2	1,53	5,23	1,32	132,8	0,62	4,41
return gas temp.	-23,3	-10	222,2	759	191,2	1,61	5,48	1,38	138,4	0,65	4,82
RGT= 32/90	-20	-4	261,7	894	225,2	1,75	5,97	1,50	149,7	0,71	5,68
liquid temp	-15	5	330,7	1129	284,6	1,97	6,73	1,70	167,8	0,81	7,21
Tliq= 45/113	-10	14	412,5	1409	355,0	2,21	7,55	1,90	186,6	0,90	9,03
[°C / °F]	-35	-31	85,6	292	73,7	0,80	2,73	0,69	107,1	0,45	2,04
cond. pressure	-30	-22	125,3	428	107,8	1,03	3,53	0,89	121,3	0,53	2,99
pc= 55/131	-25	-13	170,5	582	146,7	1,23	4,19	1,06	138,8	0,63	4,08
return gas temp	-23,3	-10	187,4	640	161,3	1,29	4,40	1,11	145,3	0,66	4,48
RGT= 32/90	-20	-4	222,9	761	191,8	1,41	4,80	1,21	158,6	0,73	5,35
liquid temp	-15	5	284,4	971	244,8	1,58	5,39	1,36	180,0	0,84	6,85
Tliq= 55/131	-10	14	356,8	1218	307,1	1,76	6,02	1,52	202,3	0,95	8,63

Optimization + standard conditions

200-240V/50Hz 1~, RSCR, static, VDE, EAC

		Evaporating pressure (saturation temperature)				Condensing pressure (saturation temperature)			Return gas temp.		Liquid temp.		Cooling capacity			COP	EER	Power consumption			Ref. mass flow m [kg/h]		
pe	pc	RGT	Tliq	[W]	[Btu/h]	[kcal/h]	[W/W]	[Btu/Wh]	[kcal/Wh]	[W]	[A]	P1	I										
[°C]	[°C]	[°C]	[°C]	[W]	[Btu/h]	[kcal/h]	[W/W]	[Btu/Wh]	[kcal/Wh]	[W]	[A]	[W]	[A]	[W]	[A]	[W]	[A]	[W]	[A]	[W]	[A]	[kg/h]	
-23,3	54,4	32,2	32,2	231,5	791	199,2	1,60	5,46	1,38	144,8	0,66	144,8	0,66	144,8	0,66	144,8	0,66	144,8	0,66	144,8	0,66	4,49	ASHRAE LBP
[-10]	130	90	90																			4,49	
-25	55	32	55	170,5	582	146,7	1,23	4,19	1,06	138,8	0,63	138,8	0,63	138,8	0,63	138,8	0,63	138,8	0,63	138,8	0,63	4,08	cecomaf LBP
[-13]	131	89,6	131																			4,08	
-35	40	20	40	121,3	414	104,4	1,16	3,96	1,00	104,7	0,48	104,7	0,48	104,7	0,48	104,7	0,48	104,7	0,48	104,7	0,48	2,66	EN12900 LBP
[-31]	104	68	104																			2,66	
-23,3	48,9	4,44	48,9	190,7	651	164,1	1,35	4,62	1,16	141,1	0,64	141,1	0,64	141,1	0,64	141,1	0,64	141,1	0,64	141,1	0,64	5,04	ARI540 LBP
[-10]	120	40	120																			5,04	
-23,3	40,6	32,2	32,2	253,4	865	218,0	1,87	6,39	1,61	135,4	0,66	135,4	0,66	135,4	0,66	135,4	0,66	135,4	0,66	135,4	0,66	4,92	AHAM LBP
[-10]	105	90	90																			4,92	
-35	45	32	45	112,9	386	97,2	1,06	3,62	0,91	106,4	0,46	106,4	0,46	106,4	0,46	106,4	0,46	106,4	0,46	106,4	0,46	2,44	opt
[-31]	113	89,6	113																			2,44	

Private Picture Copyright : WWW.MBSM.PRO

Compresseur	Réfrigération Q, W	Rendez-vous	Source de courant	Coût, frotter	Disponibilité
cubigel GL99AAb R134a (LBP)	237	Basse température	1 phase / 220 V / 50 Hz	n / a	0 pièces
cubigel GL90AAa R134a (LBP)	223	Basse température	1 phase / 220 V / 50 Hz	4 324,52	5 pièces et plus
cubigel GL90AAb R134a (LBP)	223	Basse température	1 phase / 220 V / 50 Hz	n / a	0 pièce
cubigel GL90ANa	221	Basse température	1 phase / 220 V / 50 Hz	n / a	0 pièces
cubigel GL90ANb	221	Basse température	1 phase / 220 V / 50 Hz	n / a	0 pièces
cubigel GL90ANc	221	Basse température	1 phase / 220 V / 50 Hz	n / a	0 pièces
cubigel GL99AAa R134a (LBP)	237	Basse température	1 phase / 220 V / 50 Hz	4 384,85	5 pièces et plus
cubigel GLY80AAa	221	Basse température	1 phase / 220 V / 50 Hz	n / a	0 pièces
cubigel GLY80AAb	221	Basse température	1 phase / 220 V / 50 Hz	n / a	0 pièces
cubigel HYE81Ya	235	Basse température	1 phase / 220 V / 50 Hz	3 021,23	5 pièces et plus
embraco NEK1118Z R-134a / LBP / 8,39 cm3	224	Basse température	1 phase / 220 V / 50 Hz	5 917,97	5 pièces et plus
embraco NEK2117GK	235	Basse température	1 phase / 220 V / 50 Hz	n / a	0 pièces
SECOP NL9F	212	Basse température	1 phase / 220 V / 50 Hz	n / a	0 pièces
SECOP NL9FT (LBP)	220	Basse température	1 phase / 220 V / 50 Hz	5 950,37	5 pièces et plus
SECOP GTK80AT (R134a)	232	Basse température	1 phase / 220 V / 50 Hz	3 650,38	5 pièces et plus
Kvausok AE2410Y_FZ1A R134a	240	Basse température	1 phase / 220 V / 50 Hz	n / a	0 pièces
Kvausok AE1390Y_FZ1A	214	Basse température	1 phase / 220 V / 50 Hz	n / a	0 pièces

Private Picture Copyright : WWW.MBSM.PRO



Les compresseurs Secop R134a sont excellents pour un usage domestique. Ils sont utilisés non seulement dans les réfrigérateurs ménagers et les congélateurs conventionnels de petit volume, mais aussi dans les équipements des mini-magasins où une source autonome de froid est nécessaire, par exemple:

- vitrines réfrigérées;
- royaux;

– armoires pour le refroidissement des produits laitiers et de l'eau.

Caractéristique:

Puissance frigorifique – 232 W

Réfrigérant – R-134

Compresseur Secop GTK80AT

Attributs de base

Pays du fabricant	L'Autriche
Fabricant	Secop (anciennement ACC)

caractéristiques supplémentaires

Capacité de refroidissement	231,5
Fréon	R134a
Volume de travail, cm ³	7,7

Caractéristique

Fabricant	Secop (Danfoss)
Marque du compresseur	Secop
Modèle	GTK
Type de compresseur	Piston scellé
But du compresseur	Basse température
Régulation des performances	Non
Alimentation du compresseur	1 phase / 220 V / 50 Hz
Plage de puissance frigorifique (EN 12900), kW	0-1
Puissance frigorifique (ASHRAE), kW	0,232
Hauteur, mm	174
Longueur, mm	215
Largeur, mm	151
Poids net / kg	9,1
Quantité d'huile, l	0,156
Niveau sonore, dBA	60
Tuyau de dérivation d'aspiration, mm	6,5
Tuyau de dérivation de refoulement, mm	5.5
Volume du cylindre, cm ³	7,7
Réfrigérant	R134a

[Mbsm_dot_pro_private_PDF_GTK80ATTélécharger](#)

[Mbsm_dot_pro_private_PDF_GTK80AT-1Télécharger](#)

[Mbsm_dot_pro_private_PDF_GTK80AT-2Télécharger](#)

Samsung, réfrigérateur, MSA150H-L1A, compresseur, R134A, 220-240 V/50Hz, LBP, 1/6 HP, 1/5 HP, 177 w

Category: compressor

written by www.mbsm.pro | 31 December 2020

Détails rapides

N ° de modèle:	MSA150H-L1A
Capacité de refroidissement:	177 W
Réfrigérant:	R134A
Application:	Réfrigérateur
Tension:	220V 60Hz
Marque déposée:	samsung



Private Picture Copyright : WWW.MBSM.PRO



Private Picture Copyright : WWW.MBSM.PRO

Samsung Reciprocating Compressor est un partenaire mondial qui fournit des fonctionnalités durables et respectueuses de l'environnement pour tous vos besoins de refroidissement. Il existe quatre séries de compresseurs à piston: MAS, NC, MSE, MSV

Modèle	moteur	V-Hz	Kcal / heure	Watt	BTU / heure	Watt	Kcal / Wh	W / W	BTU / Wh	AMP
MSA141C-S1A	PTC-RSIR	115-60	121	140	479	98,3	1,23	1,43	4,87	1,35
MSA141C-S1B	PTC-RSCR	115-60	121	140	479	93,5	1,29	1,50	5,13	0,91
MSA143C-S1B	PTC-RSCR	115-60	121	140	479	91,5	1,32	1,53	5,23	0,91
MSA150C-L1A	PTC-RSIR	115-60	148	172	588	119,8	1,24	1,44	4,90	1,63
MSA151C-L1B	PTC-RSCR	115-60	148	172	588	110,0	1,35	1,56	5,34	1,03
MSA151C-L1G	PTC-RSCR	115-60	148	172	588	105,2	1,41	1,64	5,58	0,96
MSA152C-L1G	PTC-RSCR	115-60	148	172	588	102,2	1,45	1,68	5,74	0,93
MSA160C-L1A	PTC-RSIR	115-60	182	212	723	150,9	1,21	1,40	4,79	2,10
MSA161C-L1A	PTC-RSIR	115-60	182	212	723	148,0	1,23	1,43	4,88	2,06
MSA170C-L1B	PTC-RSCR	115-60	214	249	850	155,8	1,38	1,60	5,46	1,65

MSA171C-L1B PTC-RSCR	115-60 214	249	850	157,7	1,36	1,58	5,39	1,65
NC1A30DLA PTC-RSIR	115-60 78	91	309	76,9	1,01	1,18	4,02	1,05
NC1A37DLB PTC-RSCR	115-60 105	122	418	97,4	1,08	1,26	4,29	0,92
NC1A43DLB PTC-RSCR	115-60 117	136	464	98,3	1,19	1,38	4,71	0,94
MSA162D-S1G PTC-RSCR	115-60 182	212	723	129,5	1,41	1,63	5,58	1,39
	127-60 182	212	723	129,5	1,41	1,63	5,58	1,39
NC1A37HLB PTC-RSCR	220-50 88	102	348	81,8	1,07	1,25	4,25	0,50
	220-60 105	122	418	98,2	1,07	1,25	4,25	0,48
NC1A43HLB PTC-RSCR	220-50 93	108	367	83,7	1.10	1,28	4,38	0,52
	220-60 117	136	464	105,8	1.10	1,28	4,38	0,49
MSA141H-L1A PTC-RSIR	220-50 93	109	371	80,8	1,16	1,34	4,59	0,67
	220-60 121	140	479	104,4	1,16	1,34	4,59	0,66
MSA150H-L1A PTC-RSIR	220-50 122	142	483	107,1	1.14	1,32	4,51	0,86
	220-60 148	172	588	130,2	1.14	1,32	4,51	0,81
MSA160H-L1A PTC-RSIR	220-50 147	171	584	132,4	1.11	1,29	4,41	1.12
	220-60 182	212	723	164,0	1.11	1,29	4,41	1,02
MSA161H-L1A PTC-RSIR	220-50 147	171	584	131,5	1.12	1,30	4,44	1.10
	220-60 182	212	723	162,8	1.12	1,30	4,44	1,00
MSA170H-L1B PTC-RSCR	220-50 168	196	669	137,3	1,23	1,43	4,87	0,81
	220-60 214	249	850	174,6	1,23	1,43	4,87	0,72
MSA170H-L1G PTC-RSCR	220-50 168	196	669	124,6	1,35	1,57	5,36	0,73
	220-60 214	249	850	158,5	1,35	1,57	5,36	0,73
MSA171H-L1B PTC-RSCR	220-50 168	196	669	138,3	1,22	1,42	4,83	0,78
	220-60 214	249	850	175,8	1,22	1,42	4,83	0,76
NC1A37BLA PTC-RSIR	220-60 105	122	418	100,3	1,05	1,22	4.16	0,70
MSA162B-L1G PTC-RSCR	220-60 182	212	723	126,6	1,44	1,67	5,71	0,60
NC1A30GLA PTC-RSIR	220-50 66	77	263	69,1	0,96	1.11	3,80	0,59
	220-60 78	91	309	81,3	0,96	1.11	3,80	0,54
MSA151G-L1B PTC-RSCR	220-50 120	139	475	91,5	1,31	1,52	5,19	0,50
	220-60 148	172	588	113,1	1,31	1,52	5,19	0,50
MSA162G-L1B PTC-RSCR	220-50 147	176	599	112,0	1,31	1,53	5,21	0,70
	220-60 182	217	742	138,7	1,31	1,53	5,21	0,67
NC1A37QLB PTC-RSCR	220-50 88	102	348	77,9	1.13	1,31	4,46	0,43
MSA141Q-S1A PTC-RSIR	220-50 93	109	371	80,8	1,16	1,34	4,59	0,67
MSA150Q-L1A PTC-RSIR	220-50 122	142	483	101,3	1,20	1,40	4,77	0,71
	240-50 122	142	483	101,3	1,20	1,40	4,77	0,74
MSA153Q-L1A PTC-RSIR	220-50 122	142	483	108,1	1.13	1,31	4,47	0,78
	240-50 122	142	483	108,1	1.13	1,31	4,47	0,82
MSA160Q-L1A PTC-RSIR	220-50 147	171	584	122,7	1,20	1,39	4,76	0,87
	240-50 147	171	584	122,7	1,20	1,39	4,76	0,91
MSA161Q-L1A PTC-RSIR	220-50 147	171	584	118,8	1,24	1,44	4,91	0,86
	240-50 147	171	584	118,8	1,24	1,44	4,91	0,90
MSA161Q-L1B PTC-RSCR	220-50 147	171	584	113,0	1,30	1,51	5,17	0,65
	240-50 147	171	584	113,0	1,30	1,51	5,17	0,65
MSA162Q-L1G PTC-RSCR	220-50 147	171	584	103,2	1,42	1,66	5,65	0,48

MSA163Q-L1A PTC-RSIR	220-50	147	171	584	130,5	1.13	1,31	4,47	0,94
	240-50	147	171	584	130,5	1.13	1,31	4,47	1,02
MSA170Q-L1B PTC-RSCR	220-50	168	196	669	125,6	1,34	1,56	5,32	0,61
MSA170Q-L1G PTC-RSCR	220-50	168	196	669	119,8	1,41	1,64	5,58	0,58
MSA171Q-L1B PTC-RSCR	220-50	168	196	669	127,6	1,32	1,54	5,24	0,63
NC1A43KLB PTC-RSCR	220-50	93	108	367	81,8	1.13	1,32	4,49	0,46
MSA141K-L1A PTC-RSIR	220-50	93	109	371	83,7	1.12	1,30	4,43	0,65
MSA141K-S1A PTC-RSIR	220-50	93	109	371	80,8	1,16	1,34	4,59	0,67
MSA141K-S1B PTC-RSCR	220-50	93	109	371	76,9	1,22	1,41	4,82	0,44
MSA143K-S1B PTC-RSCR	220-50	93	109	371	75,0	1,25	1,45	4,95	0,45
MSA151K-S1G PTC-RSCR	220-50	122	142	483	99,3	1,23	1,42	4,86	0,57
MSA162K-S1G PTC-RSCR	220-50	147	171	584	113,9	1,29	1,50	5.12	0,62
MSA170K-S1G PTC-RSCR	220-50	168	196	669	128,5	1,31	1,52	5.20	0,73
MSA150E-L1A PTC-RSIR	100-50	122	142	483	109,1	1.12	1,30	4,43	1,88
	100-60	148	172	588	132,6	1.12	1,30	4,43	1,80
MSA160E-L1A PTC-RSIR	100-50	147	171	584	135,4	1,09	1,26	4,31	2,45
	100-60	182	212	723	167,6	1,09	1,26	4,31	2,25
MSA162P-S1B PTC-RSCR	127-60	182	217	742	133,4	1,36	1,59	5,42	1,17

Model	Motor Type	Voltage [V-Hz]	Cooling Capacity			Power Input W	Efficiency			Cooling Type
			kcal/Hr	Watt	BTU/Hr		EFF Kcal/WHr	COP W/W	EER BTU/WHr	
CD124Q-L1Z2	RSIR	220-50	43	50	171	57	0.75	0.88	2.99	ST
CD130Q-L1Z2	RSIR	220-50	58	67	230	65	0.89	1.04	3.54	ST
CD130Q-S1ZA	RSIR	220-50	58	67	230	74	0.78	0.91	3.11	ST
SD137Q-L1ZB	RSIR	220-50	75	87	298	86	0.87	1.01	3.46	ST
SD137Q-L1UB	RSCR	220-50	75	87	298	80	0.94	1.09	3.72	ST
SD143Q-L1U2	RSCR	220-50	95	110	377	99	0.96	1.12	3.81	ST
MSA143Q-S1Z	RSIR	220-50	96	112	381	83	1.16	1.34	4.59	ST
SD152Q-L1UB	RSCR	220-50	120	140	476	104	1.15	1.34	4.58	ST
MD152Q-L1U2	RSCR	220-50	118	137	468	98	1.2	1.4	4.78	ST
SD162Q-L1UB	RSCR	220-50	146	170	580	125	1.17	1.36	4.64	ST
MK162Q-L1UA	RSCR	220-50	145	169	576	105	1.38	1.61	5.48	ST
MSS162Q-L1U	RSCR	220-50	151	176	599	105	1.44	1.67	5.71	ST
MSA162Q-L1G	RSCR	220-50	151	176	599	111	1.36	1.58	5.4	ST
SK170Q-L1U	RSCR	220-50	168	195	667	141	1.19	1.39	4.73	ST/OC
MSA170Q-L1B	RSCR	220-50	173	201	687	129	1.34	1.56	5.32	ST
MSA170Q-L1G	RSCR	220-50	173	201	687	126	1.37	1.6	5.45	ST
MK172Q-L2UB	RSCR	220-50	176	205	699	129	1.36	1.59	5.42	FC
SK182Q-L2U	RSCR	220-50	203	236	806	164	1.24	1.44	4.91	FC/OC
MK183Q-L2UB	RSCR	220-50	203	236	806	142	1.43	1.66	5.68	FC
SK190Q-L2U	RSCR	220-50	227	264	901	180	1.26	1.47	5.01	FC/OC
MK190Q-L2U	RSCR	220-50	225	262	893	157	1.43	1.67	5.69	FC
SK1A1Q-L2UB	RSCR	220-50	275	320	1092	229	1.2	1.4	4.77	FC
NC1A37QLB	RSCR	220-50	90	105	357	80	1.13	1.31	4.47	ST

Cooling Type	Motor Type	ASHRAE Conditions (LBP)	Unit Conversion Table
FC : Fan cooling	RSIR : Resistance Start Induction Run	Evaporating Temp. : -23.3°C (-10°F)	1 watt = 3.41 Btu/Hr
OC : Oil cooling	RSCR : Resistance Start Capacitor Run	Condensing Temp. : 54.4°C (130°F)	1 watt = 0.86 Kcal/Hr
ST : Static	CSIR : Capacitor Start Induction Run	Gas Superheated to : 32.2°C (90°F)	1 Kcal/Hr = 3.97 Btu/Hr
	CSR : Capacitor Start Capacitor Run	Liquid sub-cooled to : 32.2°C (90°F)	
		Ambient Temp. : 32.2°C (90°F)	



Détails rapides

N ° de modèle: MSA150H-L1A
 Capacité de refroidissement: 177 W
 Réfrigérant: R134A
 Application: Réfrigérateur
 Tension: 220V 60Hz
 Marque déposée: samsung



Private Picture Copyright: WWW.MBSM.PRO

Tension	Modèle	Type de moteur	Capacité de refroidissement / w (50Hz)	Capacité de refroidissement / w (60Hz)	Entrée / w (50Hz)	Entrée / w (60Hz)	COP (50 Hz)	COP (60 Hz)
200-220v 50Hz 220V 60Hz	MSA141H-L1A	RSIR	112	144	88	103	1,27	1,40
	MSA150H-L1A	RSIR	145	177	110	123	1,32	1,44
	MSA160H-L1A	RSIR	176	217	136	150	1,29	1,45
	MSA171H-L1B	RSCR	201	256	142	161	1,42	1,59
220-240V 50Hz	MSA151G-L1B	RSCR	143	177	94	110	1,52	1,61
220V 60Hz	MSA162G-L1B	RSCR	176	217	115	135	1,5	1,61



Private Picture Copyright: WWW.MBSM.PRO

RATED VOLTAGE	MODEL	MOTOR TYPE	VOLTAGE [V-Hz]	ASHRAE							COOLING TYPE
				COOLING CAPACITY			POWER INPUT	EFFICIENCY			
				kcal/h	Watts	Btu/h		Watts	EFF	COP	
AC 200-220V-50Hz, 220V-60Hz	MSA141H-L1A	RSIR	220-50	96	112	381	83	1.16	1.34	4.59	ST
			220-60	124	144	492	103	1.20	1.40	4.78	
	MSA143H-L1A	RSIR	220-50	95	110	377	85	1.12	1.30	4.43	ST
			220-60	128	149	508	102	1.25	1.46	5.00	
	MSA150H-L1A	RSIR	220-50	125	145	496	110	1.14	1.32	4.51	ST
			220-60	152	177	603	123	1.24	1.44	4.90	
	MSA151H-L1A	RSIR	220-50	128	149	508	107	1.20	1.39	4.75	ST
			220-60	152	177	603	121	1.26	1.46	5.00	
	MSA160H-L1A	RSIR	220-50	151	176	599	136	1.11	1.29	4.41	ST
			220-60	187	217	742	150	1.25	1.45	4.95	
	MSA161H-L1A	RSIR	220-50	151	176	599	135	1.12	1.30	4.44	ST
			220-60	187	217	742	149	1.26	1.46	4.98	
	MSA162H-L1A	RSIR	220-50	152	177	603	141	1.08	1.25	4.28	ST
			220-60	192	223	762	153	1.25	1.46	5.00	
	MSA162H-L1H	RSCR	220-50	152	177	603	110	1.38	1.61	5.50	ST
			220-60	192	223	762	134	1.43	1.67	5.70	
	MSA171H-L1B	RSCR	220-50	173	201	687	142	1.22	1.42	4.83	ST
			220-60	220	256	873	161	1.37	1.59	5.42	

Private Picture Copyright : WWW.MBSM.PRO



Private Picture Copyright : WWW.MBSM.PRO

Mbsm_dot_pro_private_PDF_SAMSUNG-COMPRESSOR-2020Télécharger

COMPRESSEUR, RÉFRIGÉRATION, 1/5 HP, ZR57AA, RSCR, Condensateur Run, LBP, 166 W, R134a

Category: compressor

written by www.mbsm.pro | 31 December 2020



Private Picture Copyright : WWW.MBSM.PRO

Modèle ZR57AA (1 / 5HP)

Caractéristiques

Type de moteur	RSCR (Condensateur Run) LBP
Volt	220 à 240 V, 50 Hz
Capacité de refroidissement	166 W
FLIC	1,48
La puissance d'entrée	112 W
Courant évalué	0,62 ampères
Réfrigérant	R134a



Private Picture Copyright : WWW.MBSM.PRO



Private Picture Copyright : WWW.MBSM.PRO



Private Picture Copyright : WWW.MBSM.PRO



Private Picture Copyright : WWW.MBSM.PRO



Private Picture Copyright : WWW.MBSM.PRO

Mbsm_dot_pro_private_PDF_ZR57AATélécharger

1/5 HP Zero Refrigeration Compressor

Model	ZR57AA (1/5HP)
Specifications	
Motor Type	RSCR (Capacitor run) LBP
Volt	220-240V, 50Hz
Cooling Capacity	166W
COP	1,48
Input Power	112W
Rated Current	0,62 Amps
Refrigerant	R134a

***Each unit is securely packaged in a sealed box**



Fitment Parts Supplied With Each Unit



Partlist	Model/Spec	Qty
Relay Cover		1
Relay Cover Clip		1
Earth Screw	M4 x 8	1
Rubber Grommet		4
Sleeve		4
Washer		4
Screw	M6 x 30	4
Hexagon Nut	M6	4
Motor Protector	BT64-120A61D3	1
PTC Relay	QP2-15EC	1
Capacitor	4uf	1

Private Picture Copyright : WWW.MBSM.PRO

Compresseur, BAIXUE, 1/4HP ,MH79R45A,
R134a, LBP, 220 240V 50Hz,
Certificat:CCC, CE, CB, VDE, 205 W,
RSIR

Category: compressor

written by www.mbsm.pro | 31 December 2020



Private Picture Copyright : WWW.MBSM.PRO

Lieu d'origine:
Jiangsu, Chine (continentale)

Modalités de paiement:

L / C, T / T

Marque:

BAIXUE

Modèle de produits:

MH79R45A

- Détails des produits
- Profil de la société

Détails rapides

- Marque:BAIXUE
Numéro de modèle:MH79R45A
Lieu d'origine:Jiangsu, Chine (continentale)
- Type:Pièces de réfrigérateur
VOL./FRE:220 à 240 V / 50 Hz
Capacité (W):205
- COP W / W:1,35
Refroidissement:FC
Type de moteur:RSIR
- Certificat:CCC, CE, CB, VDE



公司于1982年研制出国内第一台活塞连杆结构的全封闭制冷压缩机，经过不断的技术更新、设备升级，现拥有年产能600万台无氟高效全封闭制冷压缩机的生产能力。

白雪压缩机厂严格按照标准要求组织生产经营，1997年获ISO9001质量体系认证证书；1999年获ISO14001环境管理体系认证证书。2008年，公司技术中心被国家发展和改革委员会批准为国家级企业技术中心，现有科技人员381人，直接从事产品研发的员工达264人，下设3个研究所，1个直属开发室和7个附属开发室，1个工艺工装设计室，3个中心（信息中心、质监试验中心、计量中心）和1个理化室，1个专利标准化资料室，1个技术公司。其中，研究所和直属开发室承担公司中长期的产品开发任务，附属开发室主要承担系列产品开发和改型工作。

目前，公司拥有V、S、Q、D、K、T六大系列压缩机，2013年公司陆续推出A、M和F三个新压缩机系列。白雪压缩机厂产品已得到了众多知名公司的肯定和广泛使用，其中，小排量微型压缩机质优价廉，特别是最新研发的小排量微型高效压缩机，性能系数居同行领先地位。另外，在V系列压缩机基础上开发的12V、24V直流变速压缩机，在国内处于领先地位。

R600a	FY151R45A	15.1	245	1.5	220~240/50
R134a	FH126C45A	12.6	345	1.3	220~240/50
R134a	FH137C45A	13.7	375	1.3	220~240/50
R134a	FH151S45A	15.1	410	1.2	220~240/50
V系列					
R134a	QDH2500G	2.5	60/70	1	100/50/60, 115/60
R134a	VH23R45A	2.3	55	0.85	220~240/50
R134a	VH23R26D	2.3	65	0.9	220/60
R134a	VH23R16A	2.3	68	1.1	115/60
R134a	VH28R16A	2.8	83	1.1	115/60
R134a	VH23R16G	2.3	68	1.3	115/60
R134a	VH28R16G	2.8	83	1.3	115/60
M系列					
R134a	MH28R45A	7.9	205	1.3	220~240/50
R134a	MH92R45A	9.2	245	1.3	220~240/50
R134a	MH112R45A	11.2	295	1.25	220~240/50
V系列					
R600a	VY33C45D	3.3	55	1.3	220~240/50
R600a	VY33C45G	3.3	55	1.5	220~240/50
R600a	VY35R00A	3.5	50/60	1.12	100/50~60, 115/60
R600a	VY33R16G	3.3	60	1.3	115/60
R600a	VY43R16G	4.3	77	1.3	115/60
K系列					
R600a	KY55R45A	5.5	98	1.35	220~240/50
R600a	KY55C45D	5.5	98	1.45	220~240/50
R600a	KY48C45D	4.8	80	1.55	220~240/50
R600a	KY48C45G	4.8	83	1.75	220~240/50
R600a	KY55C45G	5.5	98	1.8	220~240/50
R600a	KY51R00A	5.1	88/98	1.35	100/50~60, 115/60
R600a	KY51R16G	5.1	98	1.4	115/60





®

MH79R45A



THERMALLY PROTECTED

220-240V~50Hz 1PH

R134a



A001275



VAAT MH92R45A
THERMALLY PROTECTED
220-240V~50Hz 1PH
R134a
CE
CCC

WVW MH79R45A
THERMALLY PROTECTED
220-240V ~ 50Hz 1PH
R134a RoHS CE CCC
A001275

2020/12/26 17:16

Compresseur, 1/3 HP, Danfoss, SECOP, tropicalisé, NL10FT, R134a, 220 – 240/1/50, CSIR – RSIR, 105G6829 SECOP, 105G6869 SECOP, 105G6140 SECOP, 105G6147 SECOP, 105G6141 SECOP

Category: compressor

written by www.mbsm.pro | 31 December 2020



Private Picture Copyright : WWW.MBSM.PRO

- Marque : DANFOSS SECOP
- Modèle : NL10FT
- CYLINDRÉE (CM³)10,1
- FLUIDER-134a
- APPLICATIONLBP
- PLAGÉ D'APPLICATION-35/-10
- PUISSANCE (W)455
- PUISSANCE FRIGORIFIQUE (TK+40°C) -10/455 -20/281 -30/158 -35/113
- TENSION (V)240/1/50

- DÉMARRAGERSIR
- I.MAX (A)1,88
- Ø ASPIRATION8,2
- Ø REFOULEMENT6,2
- DIMENSIONS (MM)205x166x203

Alimentation du compresseur [V/Ph/Hz]	220-240/1/50
Applications	LBP
Charge en fluide frigorigène [kg] [Max]	0.4 kg
Code de configuration	Simple
Couleur	Noir
Courant d'appel HST [A]	10.4 A
Courant d'appel LST [A]	13.6 A
Description	NL10FT
Diamètre de raccordement à l'aspiration [mm]	8.2 mm
Diamètre du raccord au refoulement [mm]	6.2 mm
Diamètre du raccordement du traitement [mm]	6.2 mm
Désignation du modèle	Compresseur
Faible valeur de plage de tension à 50 Hz [V]	198 V
Faible valeur de plage de tension à 60 Hz [V]	0 V
Faible valeur de tension nominale à 50 Hz [V]	220 V
Faible valeur de tension nominale à 60 Hz [V]	0 V
Fluides	R134a
Format d'emballage	Emballage industriel
Fréquence [Hz]	50
Hauteur de la base [mm]	197 mm
Hauteur totale [mm]	203 mm
Injection de liquide	No
Longueur [mm]	252 mm
LRA HST 60Hz [A]	10.4 A
LRA HST [A]	10.4 A
LRA LST [A]	9.2 A
Matériel du raccord au process	Acier cuivré
Matériel du raccord d'aspiration	Acier cuivré
Matériel du raccord de refoulement	Acier cuivré
Niveau d'énergie de l'application	Tropical
Nombre de phases (compresseur)	1
Nombre de phases (ventilateur)	1
Notes concernant le raccord de refoulement	Capuchon en aluminium
Notes concernant le raccordement au process	Capuchon en aluminium
Notes concernant le raccordement à l'aspiration	Capuchon en aluminium
N° de modèle	NL10FT
Oil type	POE
Phase	1

Profondeur [mm]	166 mm
Quantité d'huile [cm ³]	300 cm ³
Quantité par emballage	80
raccord de refoulement équerre [°]	35 °
raccord d'aspiration équerre [°]	15 °
Raccordement de process équerre	25 °
RLA	1.80 A
Régulation de la puissance	Vitesse fixe
Résistance de l'enroulement auxiliaire (enroulement de démarrage) pour compresseurs monophasés [ohm]	14.7 Ohm
Résistance de l'enroulement auxiliaire (enroulement de démarrage) pour compresseurs monophasés à pistons [ohm]	14.7 Ohm
Résistance de l'enroulement principal pour compresseurs monophasés [Ohm]	8.2 Ohm
Technique de la marque	Compresseur à pistons
Technologie	Piston
Température d'enroulement max. continue [°C] [Max]	125 °C
Température de l'enroulement à court terme [°C] [Max]	135 °C
Tension 50 Hz [V]	220 V
Tension 50 Hz [V] [max.]	240 V
Type	NL
Type de moteur	CSIR RSIR
Type de socle	Petit UE
Utilisation de tronçon	Réfrigération LT
Valeur élevée de plage de tension à 50 Hz [V]	264 V
Valeur élevée de plage de tension à 60 Hz [V]	0 V
Valeur élevée de tension nominale à 50 Hz [V]	240 V
Valeur élevée de tension nominale à 60 Hz [V]	0 V
Vitesse de rotation à 50 Hz [rpm]	2900 rpm
Vitesse de rotation à 60 Hz [rpm]	0 rpm
Volume balayé [cm ³]	10.09 cm ³
Volume de gaz libre [cm ³]	2360 cm ³
Économiseur	No

Mbsm_dot_pro_private_PDF_nl10ft_105g6829_r134a_220v_50hz_04-2019_desd406p202Télécharger



Private Picture Copyright: WWW.MBSM.PRO

Compresseur, Hermétique, AE4456Y,
Tecumseh, R-134a, 3/8HP, 230V,
ae8069br, ae4456y-fz1c

Category: compressor

written by www.mbsm.pro | 31 December 2020



Private Picture Copyright : WWW.MBSM.PRO

Compresseur, Hermétique, AE4456Y, Tecumseh, R-134a, 3/8HP, 230V, ae8069br, ae4456y-fz1c

HuaJun Chine, QD36LW, 1 / 9HP, 86W , Rsir

Category: compressor

written by www.mbsm.pro | 31 December 2020



REDMI NOTE 8
AI QUAD CAMERA

Private Picture Copyright: WWW.MBSM.PRO

Série QD Compresseur de réfrigération hermétique comme
QD30LW: 68W
QD36LW: 86W
QD30: 62W
QD36: 88W

QD43: 95W

QD51: 115W

Série QD utilisée comme réfrigérants R134a, principalement pour boire, petits réfrigérateurs et autres petits

équipements de réfrigération. Sa structure une bielle de manivelle, piston alternatif, et conformément au mode de réalisation d'admission est divisée en mode d'admission d'air semi-direct et indirect.

Caractéristiques principales: poids léger, petite taille, rendement élevé, fiabilité, faible bruit,

certification de qualité à faible vibration : le CE / le CCC / VDE / Rhos



QD36LW SUPER COOL
220V~50Hz 1PH
M/HBP HST R134a
No 7065529856 MADE IN CHINA
Cooling capacity 382W
RoHS CE CCC

Suction tube

REDMI NOTE 8
AI QUAD CAMERA

Y Series R134a Compressor

Mainly used in water dispensers, ice machines and other small refrigeration equipment

Modèle	QD36LW		
Puissance	V / Hz	220-240 / 50	110-115 / 60
Disl.	(Cm) & Sup3;)	3,60	
Réfrigérant	R134a		
Capacité de refroidissement	W	86	94
La puissance d'entrée	W	92	96
Actuellement	UNE	0,74	1,25
FLIC	W / W	0,93	0,98
Ventilateur	S		
Type de moteur	RSIR		



Private Picture Copyright: WWW.MBSM.PRO



R134a-LBP Compressor Technology Data

Model	Power W/Hz	Disp. cm ³	Oil charge mL	Cooling	Motor type	Cooling capacity		C.o.p	Running current	
						W	A		W	A
COPPER AND ALUMINUM COIL										
QD30LW	220-240/50	3.08	180	ST	RSIR	68	0.80	0.93	108	0.77
	110-115/60					76	1.10	1.00	105	1.25
	127/60					76	1.10	1.00	108	1.38
QD36LW	220-240/50	3.68	190	ST	RSIR	86	0.74	0.93	135	0.95
	110-115/60					94	1.25	0.98	125	1.55
	127/60					94	1.20	0.98	130	1.55
ALL COPPER COIL										
QD30	220-240/50	3.00	180	ST	RSIR	62	0.58	0.91	104	0.75
	110-115/60					70	1.00	0.97	97	1.20
	127/60					70	1.00	0.98	105	1.35
QD36	220-240/50	3.60	180	ST	RSIR	80	0.70	0.91	130	0.90
	110-115/60					88	1.20	0.98	125	1.50
	127/60					88	1.05	0.98	128	1.50
QD43	220-240/50	4.30	200	ST	RSIR	95	0.75	1.00	145	0.95
QD51	220-240/50	5.10	200	ST	RSIR	115	0.88	1.00	156	1.05

R600a-LBP Compressor Technology Data

Model	Power supply	Cooling capacity	Rated power	Rated current	COP	Motor type	Running capacitor	Starting relay	Cooling type
QD43	220V-240V 50Hz	68W	92W	0.36A	1.25	RSIR	/	PTC	ST
QD52	220V-240V 50Hz	80W	98W	0.47A	1.3	RSIR	/	PTC	ST



Mbsm_dot_pro_private_PDF_5__QD36Download

COMPRESSEURS, 1/6, RSIR/RSCR, 124W, CUBIGEL / ACC, TUBED, R600A, 1PH, HPKD190A, COMPRESSOR – HPKD190A, R600A, Compresseur Zel

Category: compressor

written by www.mbsm.pro | 31 December 2020



Variable Speed Range 变频系列

R600a

型号	电机	转速范围	排气量	电机类型	制冷量	输入功率	性能系数	高度	重量	认证
Model	Motor	Speed Range	Displ.	Motor Type	Cooling Capacity	Input Power	COP	Height	Net Weight	Certification
		rpm	cm ³		w	w	w/w	mm	kg	
220-240V/50Hz										
T系列变频 T Series VSC										
HKD66FSK	Al	1400-4000	6.6	PMSM	45-150	26-85	Up to 1.90	163	7.1	
HKD75FSK	Al	1400-4000	7.5	PMSM	52-170	29-96	Up to 1.90	163	7.1	
HKD86FSK	Al	1400-4000	8.6	PMSM	60-190	35-105	Up to 1.90	163	7.1	
HKD93FSK	Al	1400-4000	9.3	PMSM	70-210	40-125	Up to 1.90	163	7.1	
HKD10FSK	Al	1400-4000	10.5	PMSM	83-235	49-132	Up to 1.90	163	7.1	CCC
HKD12FSK	Al	1400-4000	11.5	PMSM	95-270	51-154	Up to 1.90	163	7.1	CCC
HKD66FSK I	Cu	1400-4000	6.6	PMSM	45-150	25-82	Up to 1.95	163	8.0	
HKD75FSK I	Cu	1400-4000	7.5	PMSM	52-170	28-93	Up to 1.95	163	8.0	
HKD86FSK I	Cu	1400-4000	8.6	PMSM	60-190	32-102	Up to 1.95	163	8.0	
HKD93FSK I	Cu	1400-4000	9.3	PMSM	70-210	38-115	Up to 1.95	163	8.0	
HKD10FSK I	Cu	1400-4000	10.5	PMSM	83-235	44-123	Up to 1.95	163	8.0	CCC
HKD12FSK I	Cu	1400-4000	11.5	PMSM	95-270	50-146	Up to 1.95	163	8.0	CCC
Z系列变频 Z Series VSC										
HXZ150FSM	Al	1200-4200	6.5	PMSM	42-150	23-80	Up to 1.90	145	6.9	-
HXZ170FSM	Al	1200-4200	7.0	PMSM	50-170	26-92	Up to 1.90	145	6.9	-
HXZ200FSM	Al	1200-4200	8.6	PMSM	56-200	30-103	Up to 1.90	145	6.9	-
HXZ220FSM	Al	1200-4200	9.2	PMSM	68-220	36-120	Up to 1.90	145	6.9	-
HXZ240FSM	Al	1200-4200	9.5	PMSM	75-240	39-125	Up to 1.90	145	6.9	-
HDZ150FSM	Al	1200-4200	6.5	PMSM	42-150	25-88	Up to 1.80	145	6.3	-
HDZ170FSM	Al	1200-4200	7.0	PMSM	50-170	27-98	Up to 1.80	145	6.3	-
HDZ200FSM	Al	1200-4200	8.6	PMSM	56-200	30-110	Up to 1.80	145	6.3	-
HDZ220FSM	Al	1200-4200	9.2	PMSM	68-220	40-132	Up to 1.80	145	6.3	-
HDZ240FSM	Al	1200-4200	9.5	PMSM	75-240	43-136	Up to 1.80	145	6.3	-

Private Picture Copyright : WWW.MBSM.PRO

HPKD190A