

Compresseur, réfrigération EMBRACO, FF7.5HBK1, FF7.5HBK, R12, 1/5++ HP, (1/4hp) R134a, 158f/h, Ffc60bk, Kiriazi Egypt k 330, 330l

Category: compressor

written by www.mbsm.pro | 31 December 2020



Conçu pour faire circuler le réfrigérant R12. Ce compresseur remplace un compresseur usé ou cassé pour maintenir votre unité en parfait état et minimiser les temps d'arrêt. 1/5 + ch. 115V.

Ancien numéro de pièce FF7.5BK

Tecumseh #

AEA3425AXA

Copeland #

ARE25C3-IAA

Compresseur de réfrigération Embraco Universal FF7.5HBK . Contre-pression faible, moyenne et élevée. 1/5 + HP nominal du moteur. À utiliser avec les réfrigérateurs, les machines à glaçons, les armoires pour produits surgelés, les vitrines de produits surgelés, les vitrines, etc.

Remplace Copeland ARE25C3E-IAA, Embraco EMI60HER, FF6HBK, EME60HER, EM65HHC, EM65HNR et EGY70HLP et Tecumseh AEA1360YXA et AEA3425YXA.

Moteur: Résistive Start Inductive Run (RSIR)

Températures d'évaporation: -10 ° F à 45 ° F

Spécifications du produit

Capacité BTU HBP:	2760
Capacité BTU LBP & amp; MBP:	630
Puissance (HP):	1/5 +
Ampères à rotor bloqué (LRA):	25,0
Type de moteur:	RSIR

Niveau de compétence:

Couple de démarrage:	Ordinaire
Volts (V):	120

Embraco FF 7.5BK

THERMALLY PROTECTED	
10 LRA	
R12	1 H

220-240V
50Hz

3065

JOINVILLE - SC

MADE IN BRAZIL

513203969

03109346



Private Picture Copyright : WWW.MBSM.PRO



KIRIAZI

Made in Egypt



شركة تصنيع التبريد المصرية
كيريازي
مصنع في مصر

Model	A 310	Class	Tropical
Power Supply	220 V	Compressor	50Hz
Power Consumption (W/h / 24h)	2.9	Net Power Consumption	1.1 A
Freezing Capacity (kg / 24h)	5	Cooling System	20 BAR
Refrigerant	R 12		340 gr
Serial Number	موتور تروبيكال		

Handwritten number: 29853



Private Picture Copyright : WWW.MBSM.PRO

Mbsm_dot_pro_private_PDF_aftermarket-line-of-products-complete-en-jan-2020-4Télécharger

Mbsm_dot_pro_private_PDF_Ff75bkTélécharger

Compressor, ZMC, EGM99AZ, 1/4 Hp,
1PH, R134a, LBP, 220-240V 50Hz

Category: compressor

written by www.mbsm.pro | 31 December 2020





Private Picture Copyright: WWW.MBSM.PRO

General Data

R134a	:Refrigerant
LBP	:Application
30°C to -10°C-	:Evaporating Temperature Range
220/240V/50 HZ	:Voltage/Frequency
Static	:Compressor Cooling
Capillary Tube	:Expansion Device
Multi - 96:120 pcs	:Packaging Quantity
CE-VDE-GOST	:Approvals



Private Picture Copyright: WWW.MBSM.PRO

Mechanical Data

cm ³ 350	:Oil Charge
ester	:Oil Type Configuration
cSt 19	:Oil Type Viscosity
kg 10.25	:Weight

Electrical Data

*RSIR / RSCR	:Motor Type
187-264V	:Voltage working range at 50 Hz
130°C	:Maximum Motor Temperature
A 10.19 / 14.49	:Locked Rotor Current
25.08Ω at 25°C	:Start Winding Resistance
Ω at 25°C 7.33	:Run Winding Resistance
ph 1	:Phase



Private Picture Copyright : WWW.MBSM.PRO

External Characteristics

(mm)	Internal Diameter
6.5	Suction Connector
4.9	Discharge Connector
6.5	Process Connector
Copper	Material

Electrical Components

PTC 14Ω	:Starting Device
T0137/xx	:Motor Protection



Private Picture Copyright : WWW.MBSM.PRO

Circuit Diagram for Mod 90 Terminal Board

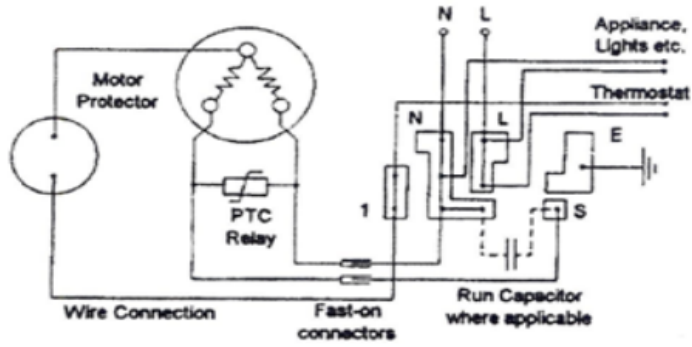

Circuit Diagram for U.H. Terminal Board

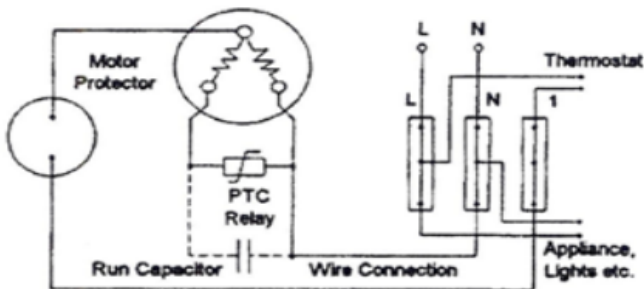

Private Picture Copyright : WWW.MBSM.PRO

PERFORMANCE CURVE DATA:

EGM99AZ

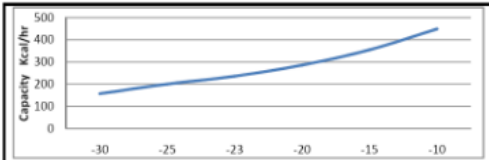

Capacity - Kcal/hr	157	200	236	286	355	449
Evap. Temp. (°C)	-30	-25	-23.3	-20	-15	-10

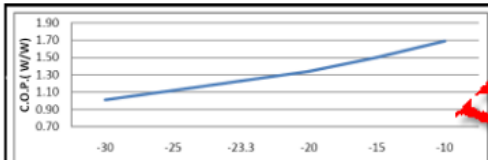

C.O.P. (W/W)	1.01	1.12	1.23	1.34	1.50	1.69
Evap. Temp. (°C)	-30	-25	-23.3	-20	-15	-10

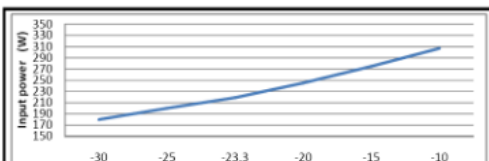

Input power (W)	180	200	219	245	275	307
Evap. Temp. (°C)	-30	-25	-23.3	-20	-15	-10

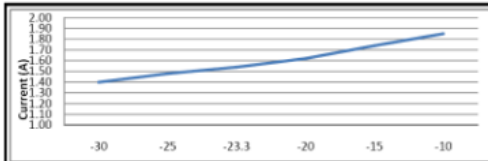

Current (A)	1.40	1.48	1.54	1.62	1.74	1.85
Evap. Temp. (°C)	-30	-25	-23.3	-20	-15	-10

Test Condition: Ashrae, Static, Return Gas 32°C Subcooling OK, Evaporating: 23.3°C, Condensing: 55°C, Ambient: 32°C

Private Picture Copyright : WWW.MBSM.PRO



ZMC
R 134 a
EGM99AZ

EMX66CTC, Embraco, compresseurs, 183w, 240v / 50 1/4 HP, R600A, hermétiques, HVAC, + Ptc, Alu, Hotpoint, Indesit, Whirlpool, LBP, Cylindrique (cm³)10,61

Category: compressor

written by www.mbsm.pro | 31 December 2020



Private Picture Copyright: WWW.MBSM.PRO

catégorie de produit

Compresseurs de réfrigération et compresseurs de climatisation

Capacité

0,14 kW (0,1840 ch)

Évaluation du réfrigérant

R-600a

EER

1,18

Source d'énergie

230/50/1

Options de réfrigérant

R-600a

Ce produit est compatible avec les modèles suivants : RSZ 3032 V L BSZ 3032 V BAAAAAN 10 SBL 2031 V/HA UPS 1721 F/HA UFAAN 400 NF UPS 1721 F J/HA UPS 1721 F

J/HA UPS 1722 F J/HA CAA 55 BAAAN 12 SBL 2030 V/HA IUPS 1722 F J IUPS 1722 F J IUPS 1721 F J EXFL 2010 P FFFL 2010 K EXFL 2010 G SBL 203A V CAA 55 NX BIAAA 12 NCAA 55 NCAA 55 NX BIAAA 10 X BIAAA 10 UIAA 12 F UIAA 22 Y UIAA 12 F R (UK) UIAA 10 F EBYH 20320 V EBL 20311 V EBL 20321 V EBLH 18311 V 03 EBYH 18321 V NCAA 55 (UK) CAA 55 (UK) CAA 55 K (UK) CAA 55 S (UK) UPSY 1721 F J UPSY 1722 F J FZFM 151 G FZFM 151 P FZFM 171 P FZFM 171 G HSZ3022VL HSZ3022VL BIAA 33 F SI Y BIAA 33 F X H Y RFAA52P RFAA52S RFAA52K EBYH 18242 F EBYH 18242 F EBYH 18201 F EBYH 18201 F UIA 12 (EX) UIA 12 S (EX) FFUL 2012 P FFUL 2012 X FFUL 2012 X BIAAA 12 X HM325NI IN C 325 AA UK STF200WP NCAA 55 S (UK) EBYH 18213 F 03 H 18223 F 03 EBYH 18223 F 03 STF200WG FUFL 2010 P EBLH 18301 V 03 FZFM 171 SB NBIAAA 10 NRFAA50S NRFAA50P EBMH 17321 NX NCAA 55 K UK CAA 55 NX UK FFFL 2013 P (03) FFFL 2013 P (03) FFFL 2013 X L 2013 X (03) EBY 18211 F BIAAA 12 UK IUPSY 1722 F J DBIAA 344 F UK UPS 1521.1 RZFM 151 P.1 RZFM 151 G.1 UPS 1521 (TK).1 FFUL 2012 G UIAA 10 (TK).1 UIAA 12 S.1 NUJAA 12.1 UIAA 12 S (UK).1 UIAA 10 S.1 UIAA 12.1 UIAA 12.1 UIAA 10. 12 (UK).1 UIAA 10 (UK).1 UIAA 10.1 BCZ L 400 X (BI)/HA HTF200WP HTF200WG UPS 1746.1 T IN C 425 AA UK FFFL 2012 P FFFL 2012 G AFAA 52 P AI AFAA 52 K AI AFAA 52 S AI CAA 55 S NCAA 55 K EBYH 18242 D F YH 18242 D F ECORM 172 P ECOFL 2010 G ECOFL 2010 G ECOFL 2010 P ECOFL 2010 P BIAAA 12P X NBIAAA 10P BIAAA 12P BIAAA 10P X BIAAA 12P UK BIAAA 10P HM325NI AI UPS 1521 F (TK) NEBYH 18242 F UIAA 12 F I X UX UIX UIX IAA 12 F I UPSI 1721 F/HA UPSI 1721 F (TK)/HA UPSI 1722 F J/HA UPSI 1722 J FSFL 2010 P FZFI 171 G FZFI 171 P UPSO 1722 F J UPSO 1721 F J IUPS0 1721 F J et plus.



COOLING CAPACITY CECDMAF																	
CONDENSING TEMPERATURE °C	EVAPORATING TEMPERATURE °C						WEIGHT kg	MAX HEIGHT A mm	LRA A	COOLING TYPE	FAN AIR FLOW m³/h	OIL		EXP DEVICE	DRAWINGS		MODEL
	-30	-25	-20	-15	-10	-5						CHARGE cm³	TYPE		EXTERNAL VIEW REFERENCE	WIRING DIAGRAM REFERENCE	
55	36	49	64	82	102	126	7,1	166	2,1	S	-	150	AB 5	C	DWG01	SM01	EMX20CLC
45	44	58	76	96	119	146											
55	43	59	80	104	133	165	7,1	166	-	S	-	150	AB 5	C	DWG01	SM01	EMX26CLC
45	53	72	96	124	156	192											
55	49	69	92	119	151	189	7,3	166	3,3	S	-	150	AB 5	C	DWG01	SM01	EMX32CLC
45	64	86	111	141	176	218											
55	-	-	-	-	-	-	7,7	171	6,8	S/F	270	150	AB 5	C/V	DWG01	SM00-SM01	EMX3109Y
45	-	-	-	-	-	-											
55	78	107	142	187	233	260	7,7	171	3,4	S	-	150	AB 5	C	DWG01	SM02	EMC40CLT
45	88	118	154	198	248	300											
55	88	119	158	203	256	280	7,1	166	-	S	-	150	AB 2	C	DWG01	SM02	EMC46CLT
45	95	129	169	215	269	310											
55	-	-	-	-	-	-	8	171	11,6	S/F	270	150	AB 5	C/V	DWG01	SM01	EMX3113Y
45	-	-	-	-	-	-											
55	87	117	154	197	245	303	7,6	166	-	S	-	150	AB 5	C	DWG01	SM01	EMX55CLC
45	102	135	175	222	277	339											
55	-	-	-	-	-	-	7,7	166	14,1	S/F	270	150	AB 5	C/V	DWG01	SM01	EMX3115Y
45	-	-	-	-	-	-											
55	101	137	178	227	284	348	7,4	166	6,4	S	-	150	AB 5	C	DWG01	SM01	EMX66CLC
45	122	160	207	261	323	394											
55	103	143	184	233	290	360	7,4	166	6	S	-	150	AB 5	C	DWG01	SM01	EMX70CLC
45	123	164	210	263	327	403											
55	-	-	-	-	-	-	7,7	166	14,1	S/F	270	150	AB 5	C/V	DWG01	SM01	EMX3118Y
45	-	-	-	-	-	-											
55	-	-	-	-	-	-	7,7	171	7,8	S/F	270	150	AB 5	C/V	DWG01	SM00	EMY3118Y

Private Picture Copyright : WWW.MBSM.PRO

MODEL	DISPL. cm³	HP	VOLTAGE/FREQUENCY	MOTOR TYPE	TORQUE	APPLICATION	RATED POINT - ASHRAE -23,3 °C / 54,4 °C		RATED POINT - CECDMAF -25 °C / 55 °C		CONDENSING TEMPERATURE °C	EVAPORATING		
							CAPACITY W	EFFICIENCY W/W	CAPACITY W	EFFICIENCY W/W		-30	-25	-20
EMX20CLC	4,0	1/14	220-240V 50Hz 1 -	RSCR	LST	LBP	63	1,66	48	1,3	55	36	49	64
											45	44	58	76
EMX26CLC	5,2	1/12	220-240V 50Hz 1 -	RSCR	LST	LBP	81	1,68	60	1,32	55	43	59	80
											45	53	72	96
EMX32CLC	6,0	1/10	220-240V 50Hz 1 -	RSCR	LST	LBP	92	1,72	69	1,35	55	49	69	90
											45	64	86	111
EMX3109Y	6,2	1/10	100V 50Hz / 100-127V 60Hz 1 -	RSIR/RSCR	LST	L/MBP	100	1,68	-	-	55	-	-	-
											45	-	-	-
EMC40CLT	7,2	1/8	220-240V 50Hz 1 -	RSCR	LST	LBP	117	1,79	87	1,4	55	78	107	142
											45	88	118	154
EMC46CLT	8,0	1/7	220-240V 50Hz 1 -	RSCR	LST	LBP	133	1,8	98	1,37	55	88	119	158
											45	95	129	169
EMX3113Y	9,0	1/7	100V 50Hz / 100-127V 60Hz 1 -	RSCR	LST	L/MBP	155	1,75	-	-	55	-	-	-
											45	-	-	-
EMX55CLC	9,0	1/6	220-240V 50Hz 1 -	RSCR	LST	LBP	156	1,74	117	1,37	55	87	117	154
											45	102	135	175
EMX3115Y	10,6	1/5	100V 50Hz / 100-127V 60Hz 1 -	RSCR	LST	L/MBP	184	1,67	-	-	55	-	-	-
											45	-	-	-
EMX66CLC	10,6	1/5	220-240V 50Hz 1 -	RSCR	LST	LBP	183	1,73	137	1,37	55	101	137	178
											45	122	160	207
EMX70CLC	11,1	1/5	220-240V 50Hz 1 -	RSCR	LST	LBP	191	1,71	143	1,34	55	103	143	184
											45	123	164	210
EMX3118Y	12,2	1/5	100V 50Hz / 100-127V 60Hz 1 -	RSCR	LST	L/MBP	212	1,66	-	-	55	-	-	-
											45	-	-	-
EMY3118Y	12,2	1/5	220-240V 50Hz 1 -	RSIR	LST	L/MBP	212	1,49	157	1,16	55	-	-	-
											45	-	-	-
EMY3118Y	12,2	1/5	220-240V 50Hz 1 -	RSCR	LST	L/MBP	213	1,58	158	1,23	55	-	-	-
											45	-	-	-
EMX3118Y	12,2	1/5	220-240V 50Hz 1 -	RSCR	LST	L/MBP	214	1,72	159	1,34	55	-	-	-
											45	-	-	-

Private Picture Copyright : WWW.MBSM.PRO

Mbsm_dot_pro_private_PDF_emx66clc-1-embraco-compressors-10-2019Télécharger
Mbsm_dot_pro_private_PDF_emx66clc-2-embraco-compressors-10-2019Télécharger

Compresseur, BAIXUE, 1/4HP ,MH79R45A,

R134a, LBP, 220 240V 50Hz,
Certificat:CCC, CE, CB, VDE, 205 W,
RSIR

Category: compressor

written by www.mbsm.pro | 31 December 2020



Lieu d'origine:
Jiangsu, Chine (continentale)

Modalités de paiement:

L / C, T / T

Marque:

BAIXUE

Modèle de produits:

MH79R45A

- Détails des produits
- Profil de la société

Détails rapides

- Marque:BAIXUE
Numéro de modèle:MH79R45A
Lieu d'origine:Jiangsu, Chine (continentale)
- Type:Pièces de réfrigérateur
VOL./FRE:220 à 240 V / 50 Hz
Capacité (W):205
- COP W / W:1,35
Refroidissement:FC
Type de moteur:RSIR
- Certificat:CCC, CE, CB, VDE



公司于1982年研制出国内第一台活塞连杆结构的全封闭制冷压缩机，经过不断的技术更新、设备升级，现拥有年产能600万台无氟高效全封闭制冷压缩机的生产能力。

白雪压缩机厂严格按照标准要求组织生产经营，1997年获ISO9001质量体系认证证书；1999年获ISO14001环境管理体系认证证书。2008年，公司技术中心被国家发展和改革委员会批准为国家级企业技术中心，现有科技人员381人，直接从事产品研发的员工达264人，下设3个研究所，1个直属开发室和7个附属开发室，1个工艺工装设计室，3个中心（信息中心、质监试验中心、计量中心）和1个理化室，1个专利标准化资料室，1个技术公司。其中，研究所和直属开发室承担公司中长期的产品开发任务，附属开发室主要承担系列产品开发和改型工作。

目前，公司拥有V、S、Q、D、K、T六大系列压缩机，2013年公司陆续推出A、M和F三个新压缩机系列。白雪压缩机厂产品已得到了众多知名公司的肯定和广泛使用，其中，小排量微型压缩机质优价廉，特别是最新研发的小排量微型高效压缩机，性能系数居同行领先地位。另外，在V系列压缩机基础上开发的12V、24V直流变速压缩机，在国内处于领先地位。

R600a	FY151R45A	15.1	245	1.5	220~240/50
R134a	FH126C45A	12.6	345	1.3	220~240/50
R134a	FH137C45A	13.7	375	1.3	220~240/50
R134a	FH151S45A	15.1	410	1.2	220~240/50
V系列					
R134a	QDH2500G	2.5	60/70	1	100/50/60, 115/60
R134a	VH23R45A	2.3	55	0.85	220~240/50
R134a	VH23R26D	2.3	65	0.9	220/60
R134a	VH23R16A	2.3	68	1.1	115/60
R134a	VH28R16A	2.8	83	1.1	115/60
R134a	VH23R16G	2.3	68	1.3	115/60
R134a	VH28R16G	2.8	83	1.3	115/60
M系列					
R134a	MH28R45A	7.9	205	1.3	220~240/50
R134a	MH92R45A	9.2	245	1.3	220~240/50
R134a	MH112R45A	11.2	295	1.25	220~240/50
V系列					
R600a	VY33C45D	3.3	55	1.3	220~240/50
R600a	VY33C45G	3.3	55	1.5	220~240/50
R600a	VY35R00A	3.5	50/60	1.12	100/50~60, 115/60
R600a	VY33R16G	3.3	60	1.3	115/60
R600a	VY43R16G	4.3	77	1.3	115/60
K系列					
R600a	KY55R45A	5.5	98	1.35	220~240/50
R600a	KY55C45D	5.5	98	1.45	220~240/50
R600a	KY48C45D	4.8	80	1.55	220~240/50
R600a	KY48C45G	4.8	83	1.75	220~240/50
R600a	KY55C45G	5.5	98	1.8	220~240/50
R600a	KY51R00A	5.1	88/98	1.35	100/50~60, 115/60
R600a	KY51R16G	5.1	98	1.4	115/60





®

MH79R45A



THERMALLY PROTECTED

220-240V~50Hz 1PH

R134a



A001275



WVW MH79R45A
THERMALLY PROTECTED
220-240V ~ 50Hz 1PH
R134a RoHS CE CCC
A001275

2020/12/26 17:16

Compresseur, 1/3 HP, Danfoss, SECOP, tropicalisé, NL10FT, R134a, 220 – 240/1/50, CSIR – RSIR, 105G6829 SECOP, 105G6869 SECOP, 105G6140 SECOP, 105G6147 SECOP, 105G6141 SECOP

Category: compressor

written by www.mbsm.pro | 31 December 2020



Private Picture Copyright : WWW.MBSM.PRO

- Marque : DANFOSS SECOP
- Modèle : NL10FT
- CYLINDRÉE (CM³)10,1
- FLUIDER-134a
- APPLICATIONLBP
- PLAGÉ D'APPLICATION-35/-10
- PUISSANCE (W)455
- PUISSANCE FRIGORIFIQUE (TK+40°C) -10/455 -20/281 -30/158 -35/113
- TENSION (V)240/1/50

- DÉMARRAGERSIR
- I.MAX (A)1,88
- Ø ASPIRATION8,2
- Ø REFOULEMENT6,2
- DIMENSIONS (MM)205x166x203

Alimentation du compresseur [V/Ph/Hz]	220-240/1/50
Applications	LBP
Charge en fluide frigorigène [kg] [Max]	0.4 kg
Code de configuration	Simple
Couleur	Noir
Courant d'appel HST [A]	10.4 A
Courant d'appel LST [A]	13.6 A
Description	NL10FT
Diamètre de raccordement à l'aspiration [mm]	8.2 mm
Diamètre du raccord au refoulement [mm]	6.2 mm
Diamètre du raccordement du traitement [mm]	6.2 mm
Désignation du modèle	Compresseur
Faible valeur de plage de tension à 50 Hz [V]	198 V
Faible valeur de plage de tension à 60 Hz [V]	0 V
Faible valeur de tension nominale à 50 Hz [V]	220 V
Faible valeur de tension nominale à 60 Hz [V]	0 V
Fluides	R134a
Format d'emballage	Emballage industriel
Fréquence [Hz]	50
Hauteur de la base [mm]	197 mm
Hauteur totale [mm]	203 mm
Injection de liquide	No
Longueur [mm]	252 mm
LRA HST 60Hz [A]	10.4 A
LRA HST [A]	10.4 A
LRA LST [A]	9.2 A
Matériel du raccord au process	Acier cuivré
Matériel du raccord d'aspiration	Acier cuivré
Matériel du raccord de refoulement	Acier cuivré
Niveau d'énergie de l'application	Tropical
Nombre de phases (compresseur)	1
Nombre de phases (ventilateur)	1
Notes concernant le raccord de refoulement	Capuchon en aluminium
Notes concernant le raccordement au process	Capuchon en aluminium
Notes concernant le raccordement à l'aspiration	Capuchon en aluminium
N° de modèle	NL10FT
Oil type	POE
Phase	1

Profondeur [mm]	166 mm
Quantité d'huile [cm ³]	300 cm ³
Quantité par emballage	80
raccord de refoulement équerre [°]	35 °
raccord d'aspiration équerre [°]	15 °
Raccordement de process équerre	25 °
RLA	1.80 A
Régulation de la puissance	Vitesse fixe
Résistance de l'enroulement auxiliaire (enroulement de démarrage) pour compresseurs monophasés [ohm]	14.7 Ohm
Résistance de l'enroulement auxiliaire (enroulement de démarrage) pour compresseurs monophasés à pistons [ohm]	14.7 Ohm
Résistance de l'enroulement principal pour compresseurs monophasés [Ohm]	8.2 Ohm
Technique de la marque	Compresseur à pistons
Technologie	Piston
Température d'enroulement max. continue [°C] [Max]	125 °C
Température de l'enroulement à court terme [°C] [Max]	135 °C
Tension 50 Hz [V]	220 V
Tension 50 Hz [V] [max.]	240 V
Type	NL
Type de moteur	CSIR RSIR
Type de socle	Petit UE
Utilisation de tronçon	Réfrigération LT
Valeur élevée de plage de tension à 50 Hz [V]	264 V
Valeur élevée de plage de tension à 60 Hz [V]	0 V
Valeur élevée de tension nominale à 50 Hz [V]	240 V
Valeur élevée de tension nominale à 60 Hz [V]	0 V
Vitesse de rotation à 50 Hz [rpm]	2900 rpm
Vitesse de rotation à 60 Hz [rpm]	0 rpm
Volume balayé [cm ³]	10.09 cm ³
Volume de gaz libre [cm ³]	2360 cm ³
Économiseur	No

Mbsm_dot_pro_private_PDF_nl10ft_105g6829_r134a_220v_50hz_04-2019_desd406p202Télécharger



Private Picture Copyright: WWW.MBSM.PRO

HuaJun Chine, QD36LW, 1 / 9HP, 86W , Rsir

Category: compressor

written by www.mbsm.pro | 31 December 2020



● ○ REDMI NOTE 8
∞ AI QUAD CAMERA

Private Picture Copyright: WWW.MBSM.PRO

Série QD Compresseur de réfrigération hermétique comme
QD30LW: 68W
QD36LW: 86W
QD30: 62W
QD36: 88W

QD43: 95W

QD51: 115W

Série QD utilisée comme réfrigérants R134a, principalement pour boire, petits réfrigérateurs et autres petits

équipements de réfrigération. Sa structure une bielle de manivelle, piston alternatif, et conformément au mode de réalisation d'admission est divisée en mode d'admission d'air semi-direct et indirect.

Caractéristiques principales: poids léger, petite taille, rendement élevé, fiabilité, faible bruit,

certification de qualité à faible vibration : le CE / le CCC / VDE / Rhos



QD36LW SUPER COOL
220V~50Hz 1PH
M/HBP HST R134a
No 7065529856 MADE IN CHINA
Cooling capacity 382W
RoHS CE CCC

Suction tube

REDMI NOTE 8
AI QUAD CAMERA

Y Series R134a Compressor

Mainly used in water dispensers, ice machines and other small refrigeration equipment

Modèle	QD36LW		
Puissance	V / Hz	220-240 / 50	110-115 / 60
Disl.	(Cm) & Sup3;)	3,60	
Réfrigérant	R134a		
Capacité de refroidissement	W	86	94
La puissance d'entrée	W	92	96
Actuellement	UNE	0,74	1,25
FLIC	W / W	0,93	0,98
Ventilateur	S		
Type de moteur	RSIR		



Private Picture Copyright: WWW.MBSM.PRO



R134a-LBP Compressor Technology Data

Model	Power W/Hz	Disp. cm ³	Oil charge mL	Cooling	Motor type	Cooling capacity		C.o.p	Running current	
						W	A		W	A
COPPER AND ALUMINUM COIL										
QD30LW	220-240/50	3.08	180	ST	RSIR	68	0.80	0.93	108	0.77
	110-115/60					76	1.10	1.00	105	1.25
	127/60					76	1.10	1.00	108	1.38
QD36LW	220-240/50	3.68	190	ST	RSIR	86	0.74	0.93	135	0.96
	110-115/60					94	1.25	0.98	125	1.55
	127/60					94	1.20	0.98	130	1.55
ALL COPPER COIL										
QD30	220-240/50	3.00	180	ST	RSIR	62	0.58	0.91	104	0.75
	110-115/60					70	1.00	0.97	97	1.20
	127/60					70	1.00	0.98	105	1.35
QD36	220-240/50	3.60	180	ST	RSIR	80	0.70	0.91	130	0.90
	110-115/60					88	1.20	0.98	125	1.50
	127/60					88	1.05	0.98	128	1.50
QD43	220-240/50	4.30	200	ST	RSIR	95	0.75	1.00	145	0.95
QD51	220-240/50	5.10	200	ST	RSIR	115	0.88	1.00	156	1.05

R600a-LBP Compressor Technology Data

Model	Power supply	Cooling capacity	Rated power	Rated current	COP	Motor type	Running capacitor	Starting relay	Cooling type
QD43	220V-240V 50Hz	68W	92W	0.36A	1.25	RSIR	/	PTC	ST
QD52	220V-240V 50Hz	80W	98W	0.47A	1.3	RSIR	/	PTC	ST

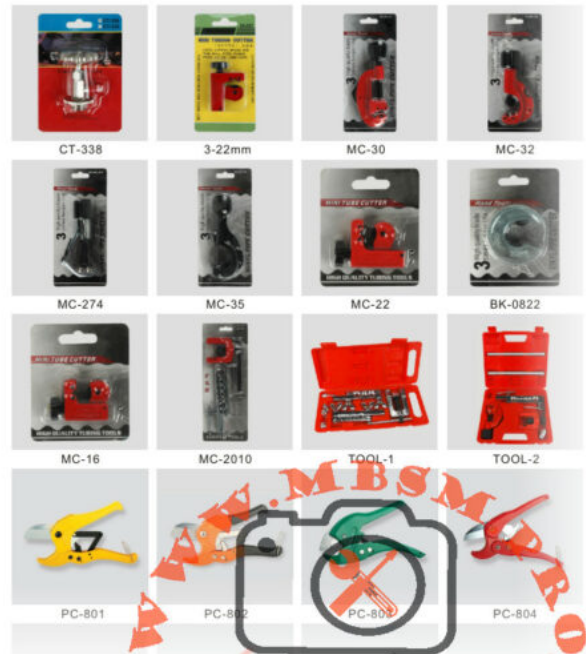

Mbsm_dot_pro_private_PDF_5__QD36Download

COMPRESSEURS, 1/6, RSIR/RSCR, 124W, CUBIGEL / ACC, TUBED, R600A, 1PH, HPKD190A, COMPRESSOR – HPKD190A, R600A, Compresseur Zel

Category: compressor

written by www.mbsm.pro | 31 December 2020



Variable Speed Range 变频系列

R600a

型号	电机	转速范围	排气量	电机类型	制冷量	输入功率	性能系数	高度	重量	认证
Model	Motor	Speed Range	Displ.	Motor Type	Cooling Capacity	Input Power	COP	Height	Net Weight	Certification
		rpm	cm ³		w	w	w/w	mm	kg	
220-240V/50Hz										
T系列变频 T Series VSC										
HKD66FSK	Al	1400-4000	6.6	PMSM	45-150	26-85	Up to 1.90	163	7.1	
HKD75FSK	Al	1400-4000	7.5	PMSM	52-170	29-96	Up to 1.90	163	7.1	
HKD86FSK	Al	1400-4000	8.6	PMSM	60-190	35-105	Up to 1.90	163	7.1	
HKD93FSK	Al	1400-4000	9.3	PMSM	70-210	40-125	Up to 1.90	163	7.1	
HKD10FSK	Al	1400-4000	10.5	PMSM	83-235	49-132	Up to 1.90	163	7.1	CCC
HKD12FSK	Al	1400-4000	11.5	PMSM	95-270	51-154	Up to 1.90	163	7.1	CCC
HKD66FSK I	Cu	1400-4000	6.6	PMSM	45-150	25-82	Up to 1.95	163	8.0	
HKD75FSK I	Cu	1400-4000	7.5	PMSM	52-170	28-93	Up to 1.95	163	8.0	
HKD86FSK I	Cu	1400-4000	8.6	PMSM	60-190	32-102	Up to 1.95	163	8.0	
HKD93FSK I	Cu	1400-4000	9.3	PMSM	70-210	38-115	Up to 1.95	163	8.0	
HKD10FSK I	Cu	1400-4000	10.5	PMSM	83-235	44-123	Up to 1.95	163	8.0	CCC
HKD12FSK I	Cu	1400-4000	11.5	PMSM	95-270	50-146	Up to 1.95	163	8.0	CCC
Z系列变频 Z Series VSC										
HXZ150FSM	Al	1200-4200	6.5	PMSM	42-150	23-80	Up to 1.90	145	6.9	-
HXZ170FSM	Al	1200-4200	7.0	PMSM	50-170	26-92	Up to 1.90	145	6.9	-
HXZ200FSM	Al	1200-4200	8.6	PMSM	56-200	30-103	Up to 1.90	145	6.9	-
HXZ220FSM	Al	1200-4200	9.2	PMSM	68-220	36-120	Up to 1.90	145	6.9	-
HXZ240FSM	Al	1200-4200	9.5	PMSM	75-240	39-125	Up to 1.90	145	6.9	-
HDZ150FSM	Al	1200-4200	6.5	PMSM	42-150	25-88	Up to 1.80	145	6.3	-
HDZ170FSM	Al	1200-4200	7.0	PMSM	50-170	27-98	Up to 1.80	145	6.3	-
HDZ200FSM	Al	1200-4200	8.6	PMSM	56-200	30-110	Up to 1.80	145	6.3	-
HDZ220FSM	Al	1200-4200	9.2	PMSM	68-220	40-132	Up to 1.80	145	6.3	-
HDZ240FSM	Al	1200-4200	9.5	PMSM	75-240	43-136	Up to 1.80	145	6.3	-

Private Picture Copyright : WWW.MBSM.PRO

HPKD190A

Compressor, Daewoo, Hfl27Ye-5-k, 134a, RSIR, LBP, 1/3HP, Ye série, 220-240V 50hz, 287 w

Category: compressor

written by www.mbsm.pro | 31 December 2020



Private Picture Copyright : WWW.MBSM.PRO

DC HEL23YG - 3
 110V 60Hz R134a
 LRA 19 THERMALLY PROTECTED RoHS
 DAEWOO ELECTRONICS Corp.
 MADE IN KOREA

 HEL23YG-3 C128130001

H E L 23 YG - 3 B
 ① ② ③ ④ ⑤ ⑥ ⑦

NO	CONTENTS	
①	Refrigerant	H : R134a I : R600a No marking : R12
②	Motor type	PTC
		C-relay
	100V Series	F : RSIR E : RSCR C : CSIR B : CSR
	220V Series	S : RSIR P : RSCR K : CSIR D : CSR
100V Series	R : RSIR N : CSIR	
220V Series	T : RSIR G : CSIR	
③	Application	L : L B P H : H B P
④	Grade of Cooling Capacity	(reference : table of capacity range)
⑤	Series name	JE Y YE YH YG
⑥	Voltage & Frequency	No marking : 100V 50/60Hz
		1 : 110-115V 60Hz
		2 : 127V 60Hz
		3 : 110V 60Hz
		4 : 220V 60Hz
5 : 220-240V 50Hz		
6 : 115-127V 60Hz		
7 : 115-127V 60Hz		
8 : 220-240V 50Hz / 220V 60Hz		
9 : 110V 50Hz		
⑦	Improvedata order	

Private Picture Copyright : WWW.MBSM.PRO

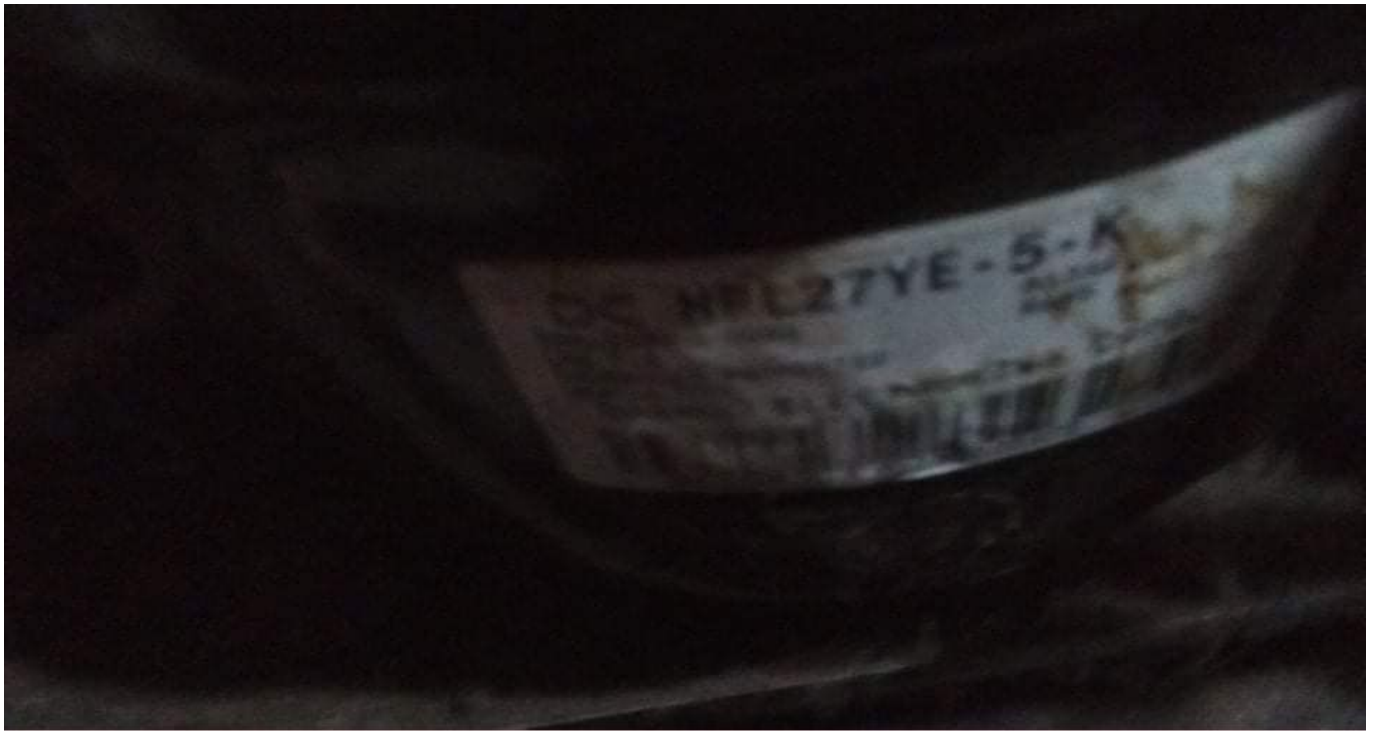

Private Picture Copyright: WWW.MBSM.PRO

Mbsm_dot_pro_private_PDF__Hfl27YeTélécharger

Mbsm_dot_pro_private_PDF_Hfl27YeTélécharger

Mbsm_dot_pro_private_PDF_Mbsm_dot_pro_private_PDFdocument-Hfl27YeTélécharger

Mbsm_dot_pro_private_PDF_R134a-LBP-Hfl27YeTélécharger

Mbsm_dot_pro_private_PDFMbsm_dot_pro_private_PDFdocument-Hfl27YeTélécharger

ELECTROLUX, CUBIGEL, Compresseur, GL90TB, R-134a, 1 / 4HP++ (big), 230V, RSCR, HMBP

Category: compressor

written by www.mbsm.pro | 31 December 2020



Private Picture Copyright : WWW.MBSM.PRO

 **Electrolux**
COMPRESSORS

GL90BH 03011
220 - 240 V ~ 50 Hz

R134a



 7625
0008146

Compressor ELECTROLUX \ CUBIGEL GL90TB

Substitutes for this compressor are: [Aspera NEK6170Z](#) , Danfoss/Secop FR10G , L'Unite Hermetique/Tecumseh AE4430Y

Refrigerant	R134A
Working range [C]	-25 to +10
Power supply	220V 50Hz
Engine type	CSIR
Power [HP]	1/4
Cylinder capacity [cm³]	8,9
Weight [kg]	10,8

Refrigerant: R134A



Private Picture Copyright : WWW.MBSM.PRO



Private Picture Copyright : WWW.MBSM.PRO

Type: Compresseurs à pistons hermétiques

Producteur: ACC

Série: HMBP

Modèle: GL90BH

Données GENERALES

Réfrigérant: R134a
Élément de décharge: C
Refroidissement: 0C
Température ambiante maximale [°C]: 43

Données du compresseur

Cylindrée [cm³]: 9,1
Déplacement [m³ / h]: 1,6
Poids [kg]: 11,1
Charge d'huile [cm³]: 470
Type d'huile: ISO VG 19 ESTER

Données du moteur

Type de moteur: RSCR
Puissance [KM]: 1/4
Élément de départ: LST
Source de courant: 220V 50Hz
Gamme de tension: 187-264
Courant rotor bloqué [A]: 13,8
Résistance d'enroulement en marche (25 ° C) [Ω]: 8,97
Résistance d'enroulement de démarrage (25 ° C) [Ω]: 18,05

Données électriques

Relais: 3003
Élément de blindage:
Volume du condensateur de démarrage [µF]: 6/400

Connexions

	millimètres	pouces
Le tube d'aspiration:	6,5	
Tube de service:	6,5	
Tube de décharge:	4,9	
Tube de refroidisseur d'huile:		4,9

[Mbsm_dot_pro_private_PDF_Cubigel_Brochure_-320102MTélécharger](#)

[Mbsm_dot_pro_private_PDF_compresseur-acc-cubigell-gl90tbTélécharger](#)

Capacité de refroidissement [W]

t _c \ t _e	-35	-30	-25	-20	-15	-dix
40	114	162	218	282	355	435
45	104	148	200	261	330	407
50	93	134	183	240	305	379
55	82	119	165	219	281	351

60 72 105 147 198 256 323

Puissance absorbée [W]

$t_c \setminus t_e$	-35	-30	-25	-20	-15	-dix
40	123	145	167	189	212	235
45	122	145	168	192	216	240
50	121	145	170	195	220	245
55	120	145	171	197	223	250
60	119	146	173	200	227	255

Actuel [A]

$t_c \setminus t_e$	-35	-30	-25	-20	-15	-dix
40	0,64	0,75	0,85	0,95	1,05	1,14
45	0,63	0,74	0,86	0,96	1,06	1,16
50	0,62	0,74	0,86	0,97	1,08	1,18
55	0,61	0,74	0,86	0,98	1,09	1,20
60	0,60	0,73	0,86	0,99	1,10	1,22

Débit massique [kg / s]

$t_c \setminus t_e$	-35	-30	-25	-20	-15	-dix
40	0,55	0,85	1,23	1,68	2,20	2,80
45	0,48	0,77	1,14	1,58	2,09	2,67
50	0,41	0,69	1,04	1,47	1,97	2,54
55	0,34	0,61	0,95	1,36	1,85	2,41
60	0,27	0,52	0,86	1,26	1,73	2,28

COP [W / W]

$t_c \setminus t_e$	-35	-30	-25	-20	-15	-dix
40	0,93	1,12	1,31	1,49	1,67	1,85
45	0,85	1,02	1,19	1,36	1,53	1,70
50	0,77	0,92	1,08	1,23	1,39	1,55
55	0,69	0,82	0,96	1,11	1,26	1,40
60	0,60	0,72	0,85	0,99	1,13	1,26

Conditions de fonctionnement: ASHRAE

t_c – Température de condensation [°C]

t_e – Température d'évaporation [°C]

[Mbsm_dot_pro_private_PDFGL90BHTélécharger](#)

[Mbsm_dot_pro_private_PDF__GL90BHTélécharger](#)

[Mbsm_dot_pro_private_PDF_danfoss_GL90TG_R134a_230_60](#)

ASPERA, COMPRESSEUR, 1 / 3HP++ (Big),

NE6181E, CSIR, HMBP, R22, 220-240V

Category: compressor

written by www.mbsm.pro | 31 December 2020



Private Picture Copyright: WWW.MBSM.PRO



Private Picture Copyright : WWW.MBSM.PRO

NE6181E 1 / 3HP / R22

- **Détails techniques**

puissance 1/3 CV, cylindrée 7,28 cm³
220 / 240V 50Hz

- LIGNE LIQUIDE (DIAMÈTRE) : 1/4
- LIGNE D'ASPIRATION (DIAMÈTRE) : 5/16
- BRÈVE DESCRIPTION



Private Picture Copyright : WWW.MBSM.PRO

Mbsm_dot_pro_private_PDF_NE6181ETélécharger