

TECUMSEH EUROPE, COMPRESSEUR,  
REFROIDISSEUR, AE1360AS, 1/5 HP,  
AE140-FS-510, Lra 9.5, LBP, R12,  
220-240V ~ 50Hz

Category: compressor

written by [www.mbsm.pro](http://www.mbsm.pro) | 7 January 2021

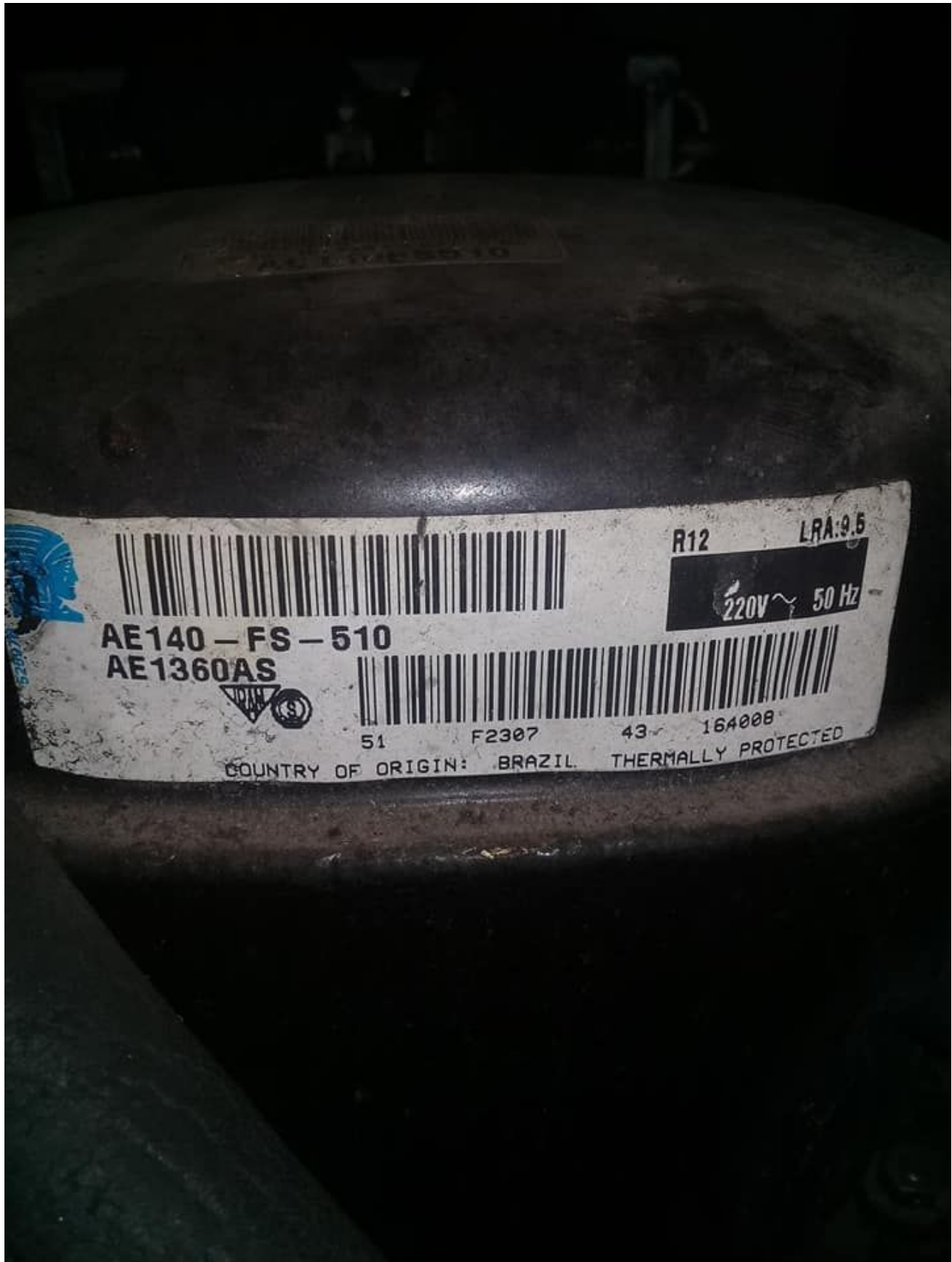

Private Picture Copyright : [WWW.MBSM.PRO](http://WWW.MBSM.PRO)

Model:AE1360AS

Product Description

Type: Reciprocating

Application: LBP – Low Back Pressure

Refrigerant: R12

Voltage/Frequency: 220-240V ~ 50Hz

## Product Specifications

### Performance

Refrigeration Capacity Input Power Efficiency

EVAP

TEMP COND AMBIENT RETURN LIQUID

Condition TEMP TEMP GAS TEMP

Test

Voltage Btu/h kcal/h W W Btu/Wh kcal/Wh W/W

ASHRAE

240V ~

50HZ 560 141 164 157 3.57 .9 1.05

-23°C (-

10°F) 54°C (130°F) 32°C (90°F) 32°C (90°F) 32°C (90°F)

General

Evaporating Temp. Range: -34.4°C to -12.2°C (-30°F to 10°F)

Motor Torque:

Low Start Torque

(LST)

Compressor Cooling: Static

Mechanical

Weight: 10.231

Weight Unit of Measure: KG

Displacement (cc): 7.55

Oil Type: N/A

Viscosity (cSt): N/A

Oil Charge (cc): N/A

Electrical

Voltage Range (50 Hz): 198-253

Voltage Range (60 Hz): N/A

Locked Rotor Amps (LRA): 11

Rated Load Amps (RLA 50 Hz): 1.12

Rated Load Amps (RLA 60 Hz): N/A

Max. Continuous Current (MCC in Amps): N/A

Motor Resistance (Ohm) – Main: 11.06

Motor Resistance (Ohm) – Start: 44.87

Motor Type: RSIR

Overload Type: N/A

Relay Type: Current Relay



Private Picture Copyright : [WWW.MBSM.PRO](http://WWW.MBSM.PRO)

Mbsm\_dot\_pro\_private\_PDF\_AE1360ASTélécharger  
Mbsm\_dot\_pro\_private\_PDF\_AE1360AS-1Télécharger  
Mbsm\_dot\_pro\_private\_PDF\_AE1360AS-2Télécharger

---

QBH57C10GPX, 1/6HP ,RSIR,  
Compressors, R134a (160g), LBP  
,PANASONIC Congélateur Electrostar  
Defrost, 5 tiroirs , blanc ,  
Electrostar, ES215DF, 188L (total  
215L), 144W, 1.1A, 220-240v-50hz

Category: compressor

written by [www.mbsm.pro](http://www.mbsm.pro) | 7 January 2021



QBH57C10GPX, 1/6HP ,RSIR, Compressors, R134a (160g), LBP ,PANASONIC Congélateur Electrostar Defrost, 5 tiroirs , blanc , Electrostar, ES215DF, 188L (total 215L), 144W, 1.1A, 220-240v-50hz,





Certains types de réfrigérateurs Panasonic An Khang fournissent:

>> Réfrigérateur Panasonic SFJ39C72RLW - 1 / 9HP - 220 ~ 240V - R134.

>> Panasonic SFJ48C87RLW Tornado - 1 / 7HP - 2240VAC - R134.

>> Réfrigérateur Panasonic QBH57C10GPX - 1 / 6HP - 2240VAC - R134.

>> Réfrigérateurs Panasonic QBH66C13GPX - 1 / 5HP - 2240VAC - R134.

>> Réfrigérateurs Panasonic QBH73C16GPX - 1 / 5HP - 2240VAC - R134.

>> Réfrigérateur Panasonic QBH86C19RPX - 1 / 4HP - 2240VAC - R134.

>> Réfrigérateur Panasonic QB110C19GAW5-1 / 3HP - 220 ~ 240V - R134.

En outre, notre société propose également d'autres types de compresseurs

Picture5 Mbsm Dot Pro : [www.mbsm.pro](http://www.mbsm.pro)

Private Picture Copyright: [WWW.MBSM.PRO](http://WWW.MBSM.PRO)







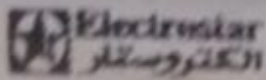

Made in Egypt

Up-Right-DeepFreezer

Model **ES 215 DF** طراز

Voltage **220-240 V ~ 50 HZ** **1.1A** **144 W**

Freezing Capacity 18 Kg/24Hr Freezer Storage Volume 198 Lit.

Total Gross Volume 215 Lit.



168515

R134a **160g** وزن وسيط

التبريد

Class T صنع في مصر

max. lamp input	Without	<del>15 W</del>
Protection Rating	IPX 4	
According To	ES 6000 / 2008 - ISO 15502 / 2005	





## Wiring Diagram For Defrost Freezers

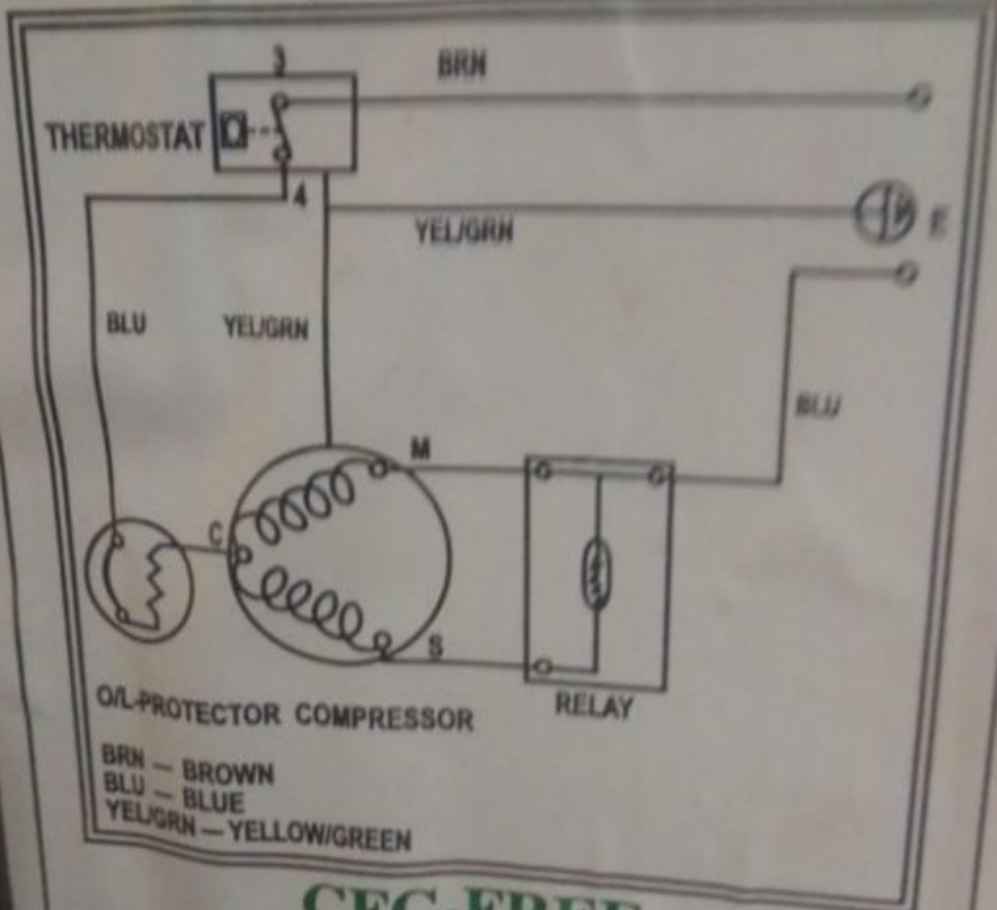

OIL-PROTECTOR COMPRESSOR

BRN - BROWN  
BLU - BLUE  
YEL/GRN - YELLOW/GREEN

**CFC-FREE**  
**REFRIGERANT : 134a**  
**FOAM : C-PENTANE**





**Panasonic** R134a



911493 8025 MP3323061

**QBH57C10GPX** 1PH

220V-50Hz

Thermally Protected  
Panasonic Corporation  
Made in Malaysia

**W**



Compresseur, Commercial Compressor,  
Disp. 11.80cc, KONOR, GPY12AF, R134a,  
200-240v , 1/3 Hp, 325w, GQR60AA,  
GPY12AF, GP16MG, GBY16AF, GQY70AA,  
DH136C25B, présentoir 420L, CSIR ,  
LBP

Category: compressor

written by [www.mbsm.pro](http://www.mbsm.pro) | 7 January 2021



Private Picture Copyright : [WWW.MBSM.PRO](http://WWW.MBSM.PRO)

Modèle	Bloc d'alimentation	Déplacement (³ de cm)	Capacité de refroidissement (w)	Puissance nominale (w)	COP (W/W)	Type de moteur	Emballage (Pcs/palette)	1× 20 FCL (PCs)
GPY12AF	200-240V/50Hz	11.8	325	244	1.33	CSIR	80	2000

**spécification**

DRIV à moteur hermétique en le compresseur du type à bielle de piston. Avec démarrage par relais de type marteau et équipé d'un protecteur de surcharge.

#### Application

Largement utilisé dans les réfrigérateurs domestiques et commerciaux, les armoires à rideaux d'air, les vitrines, les machines à glaçons, les refroidisseurs, les déshumidificateurs, etc.

Série de compresseurs haute efficacité R134aLBP

Modèle: GPY12AF

Puissance: 1 / 3HP

Déplacement: 11,8 cm<sup>3</sup>

Capacité: 325w

COP: 1,36 W

Tension: 200-240V / 50HZ

Manière de moteur: CSIR

Application: LBP

Type de refroidissement: refroidissement par ventilateur

Hauteur: 210 mm

Poids net: 12,9 kg

Dimension: 210 \* 162 \* 237.2 (millimètre)

Conditions d'essai (ASHRAE)

Température d'évaporation -23,3 ° C

Température de condensation 54,4 ° C

Température de sous-refroidissement 32,2 ° C

Température d'aspiration 32,2 ° C

Température ambiante 32,2 ° C

Conversion:

1 watt = 3,41 Btu / h = 0,86 kcal / h

**Compresseur konor GPY12AF par un présentoir de bière Quilmes 420L.**

**Modèle GPY12AF**

**Alimentation 200-240V / 50Hz**

**Cylindrée (cm<sup>3</sup>) 11,8**

**Capacité de refroidissement (W) 325**

**Puissance nominale (W) 244**

**COP (W / W ) 1.33**

**Type de moteur CSIR LBP**

**Equivalent 1/3 MTC EMBRACO modèle FFI-12-HBK pour R134.**

KONOR	Displ.	power	Motor type	V/Hz	Cooling capacity	W <sub>Net</sub>	Weight	KG
GQR60AA	61/6		RSIR	220-240V/50Hz		140		9.4
GQR70AA	6.61/5		RSIR	220-240V/50Hz		165		9.4
GQR80AA	8.11/4		RSIR	220-240V/50Hz		198		9.4
GQR90AA	9.11/4		RSIR	220-240V/50Hz		220		10.1
GQY99AA	9.91/4		RSIR	220-240V/50Hz		270		10.9
GQY12AF	11.81/3		CSIR	220-240V/50Hz		325		10.56
GQY16AF	16.23/8		CSIR	220-240V/50Hz		380		12.1
GP16MG	16.25/8		CSIR	220-240V/50Hz		870		12.5
GP12MG	11.85/8		CSIR	220-240V/50Hz		656		10.9
GP12TG	11.83/8		CSIR	220-240V/50Hz		1140		11.8
GQR80TG	8.11/4		CSIR	220-240V/50Hz		730		9.8
GQR90TG	9.11/4		CSIR	220-240V/50Hz		830		10.5
GQR60TG	61/5		CSIR	220-240V/50Hz		520		9.8

KONON

GPY12AF

220-240V~50Hz

R134a



11.11.2013

KONON ELECTROMECHANICS CO., LTD 01071.908



Private Picture Copyright : WWW.MBSM.PRO

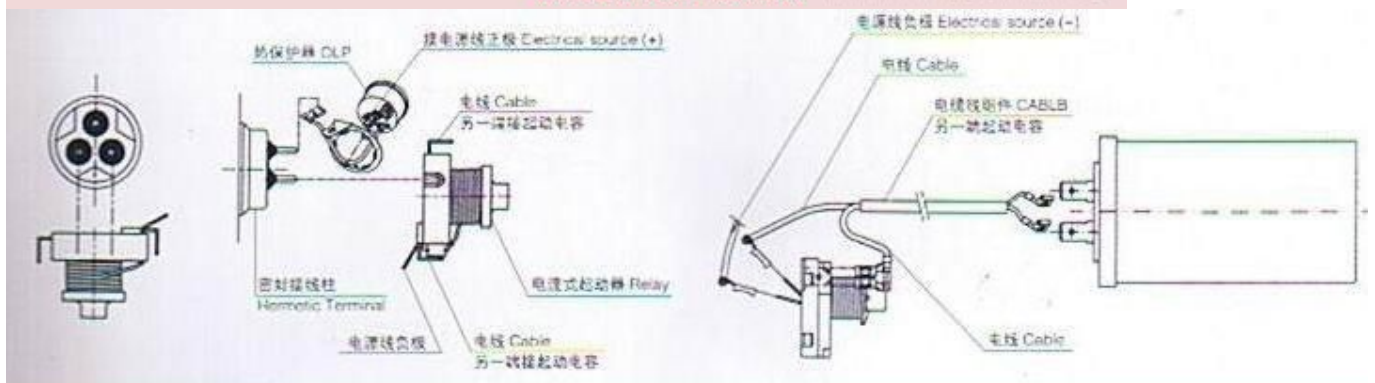

Private Picture Copyright : WWW.MBSM.PRO

## R134a 系列 | R134a Range

220-240 V / 50Hz

Cliquez pour traduire les images

型号 Model	排气 容积 Displ. cm <sup>3</sup>	电机 功率 Power HP	电机 类型 Motor Type	电压频率 Volt.-Frequency V/Hz	制冷量 Cooling Capacity w	输入功率 Input Power without RC w	with RC w	性能系数 COP without RC w/w	with RC w/w	高度 Height (A) mm	净重 Net Weight kg
GQR45AA	4.6	1/8	RSIR	220-240V/50Hz	110	96		1.15		176	8.8
GQR60AA	6.0	1/6	RSIR	220-240V/50Hz	140	116		1.21		176	9.4
GQR70AA	6.6	1/5	RSIR	220-240V/50Hz	165	136		1.21		176	9.4
GQR80AA	8.1	1/4	RSIR	220-240V/50Hz	198	166		1.19		186	9.4
GQR90AA	9.1	1/4	RSIR	220-240V/50Hz	220	184		1.19		186	10.1
GQY45AA	4.6	1/8	RSIR/RSCR	220-240V/50Hz	123	99	95	1.24	1.30	176	9.3
GQY60AA	6.0	1/6	RSIR/RSCR	220-240V/50Hz	157	115	112	1.36	1.40	176	9.4
GQY70AA	6.6	1/5	RSIR/RSCR	220-240V/50Hz	175	126	121	1.39	1.45	186	10.0
GQY80AA	8.1	1/4	RSIR/RSCR	220-240V/50Hz	222	164	158	1.35	1.41	186	10.3
GQY90AA	9.1	1/4	RSIR/RSCR	220-240V/50Hz	245	184	176	1.33	1.39	186	10.3
GQY99AA	9.9	1/4	RSIR/RSCR	220-240V/50Hz	270	203	194	1.33	1.39	199	10.9



Private Picture Copyright : WWW.MBSM.PRO

型号 Model	排气 容积 Displ. cm <sup>3</sup>	电机 功率 Power HP	电机 类型 Motor Type	电压频率 Volt.-Frequency V/Hz	制冷量 Cooling Capacity w	输入功率 Input Power without RC w with RC w	性能系数 COP without RC w/w with RC w/w	高度 Height (A) mm	净重 Net Weight kg
GQR60TG	6.0	1/5	CSIR	200-220V/50Hz 220-230V/60Hz	520 600	260 290	2.00 2.10	176	9.8
GQR80TG	8.1	1/4	CSIR	200-220V/50Hz 220-230V/60Hz	730 800	340 380	2.15 2.10	186	10.8
GQR90TG	9.1	1/4	CSIR	200-220V/50Hz 220-230V/60Hz	830 920	370 436	2.24 2.24	186	10.8
GP12TG	11.8	3/8	CSIR	200-220V/50Hz	1140	520	2.19	199	11.8

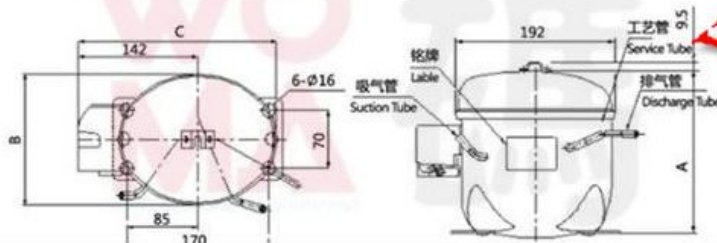

Private Picture Copyright : WWW.MBSM.PRO

## R134a 系列 | R134a Range

Cliquez pour traduire les images

200-220 V / 50Hz, 220-230 V / 60Hz

展示柜专用 | For Display Cabinet

型号 Model	排气 容积 Displ. cm <sup>3</sup>	电机 功率 Power HP	电机 类型 Motor Type	电压频率 Volt.-Frequency V/Hz	制冷量 Cooling Capacity w	输入功率 Input Power without RC w with RC w	性能系数 COP without RC w/w with RC w/w	高度 Height (A) mm	净重 Net Weight kg
GP12MG	11.8	5/8	CSIR	200-220V/50Hz 220-230V/60Hz	656 788	400 476	1.64 1.66	203	10.8
GP16MG	16.2	5/8	CSIR	200-220V/50Hz 220-230V/60Hz	870 975	560 610	1.55 1.60	212	11.2

Private Picture Copyright : WWW.MBSM.PRO

200-240V / 50Hz

上海珂纳压缩机-低背压  
 Cliquez pour traduire les images

型号	制冷量 W	输入功率 W	代替型号1	代替型号2	备注
GQR60AA	140	116	华意HYE55Y63		
GQR70AA	165	136	华意HYE60YL		
GQR80AA	198	166	华意HYE69Y63		
GQR90AA	220	184	华意HYE81Y		
GQY99AA	270	203	华意HY90Y		
GPY12AF	325	244	华意HY113Y		
GPY16AF	380	292	华意HY131Y		

200-220V / 50Hz, 220-230V / 60Hz 上海珂纳压缩机-高背压

型号	制冷量 W	输入功率 W	代替型号1	代替型号2	备注
GQR90TG	830	370	华意HYE81YZ		
GP12TG	1140	520	华意HY131YZ		
GP12MG	1140	520	华意HY131YZ		
GP16MG	1430	650	华意HY153YZ		

Private Picture Copyright : WWW.MBSM.PRO

---

# R134a, LBP, Mini Commerciale, 1/5hp compresseur, réfrigérateur, QD75H, 150W

Category: compressor

written by [www.mbsm.pro](http://www.mbsm.pro) | 7 January 2021



QD75H



220-240V-50/60Hz 1PH

R134a

NO. 2002505



RoHS

CB



CE

Hangzhou Qianjiang Refrigeration Group Co.,Ltd

# Caractéristiques

Compresseur de réfrigérateur 1 / 5HP R134A pour réfrigérateur

Compresseur AC: R134A Hermetic LBP Piston Reciprocationg

Modèle de compresseur : QD75H

Alimentation: 220 ~ 240V / 50Hz

Déplacement: 7.5CC

Capacité de refroidissement: 180W

Puissance nominale: 150W

Puissance nominale: 1 / 5HP

COP: 1,2 W / W

Type de moteur: Relais de

démarrage RSIR :

Type de refroidissement PTC : S

Application: LBP

Certification: CE

1x20'FCL: 1920PCS

Application:

LBP: Faible contre-pression; Réfrigérateur, congélateur, cave à vin

MBP: Contre-pression moyenne; Climatiseur, distributeur automatique

HBP: Contre-pression élevée: Climatiseur, machine à glaçons

Condition du test LBP ASHRAE:

Température d'Evaporation: -23,3 ° C

Température de condensation: 54,4 ° C

Température de sous-refroidissement: 32,2 ° C

Température ambiante: 32,2 ° C

MBP ASHRAE Condition de test:

Evaporation Température: -5 ° C

Température de condensation: 54,4 ° C

Température ambiante: 35 ° C

Sous-refroidissement température: 46,1

température d' aspiration: 35 ° C

RAP état ASHRAETest:

Evaporation température: 7.2° C

condensation température: 54.4° C

température ambiante: 35 ° C

sous – refroidissement température: 46.1° C

aspiration température: 35 ° C

Paramètre Plage de variation:

Capacité de refroidissement: ≥ 95 %

Puissance d'Inpurt: ≤ 115%

Courant: ≤ 110%

COP: ≥ 95%

Type de refroidissement:

S: refroidissement naturel

F1: refroidissement par ventilateur, diamètre du ventilateur de 200 mm, vitesse de l'air de 1,5 m / s

F2: refroidissement par ventilateur, diamètre du ventilateur de 200 mm, vitesse de l'air de 3 m / s

Conditions de test

Evap. Temp.: -23,3 ° C  
Cond. Temp.: 54,4 ° C  
Amb. Temp.: 32,2 ° C  
Aspiration. Temp .: 32,2 ° C  
Temp. De sous-refroidissement: 32,2 ° C

LBP ASHRAE

Modèle: QD75H  
Alimentation: 220-240V / 50Hz  
Cylindrée (cm³): 7,5  
Capacité de refroidissement (W): 180  
Puissance nominale (W): 164  
Puissance nominale (HP ): 1/5  
COP (W / W): 1,097

Courant

nominal (A): 1,35 Type de moteur:  
Condensateur RSIR (µ F): /  
Relais de démarrage: Relais d'application  
Type de refroidissement: S  
Emballage (PCS / palette): 100

1 × 20'FCL (PCS): 2000

Caractéristiques

- 1. Petite taille,
- 2. Haute efficacité et fiabilité
- 3. Performance de départ fiable
- 4. Faible son et vibration

1. Application LBP, utilisé pour la fontaine à boire, le réfrigérateur, le congélateur, l'armoire à alcool, la machine à glaçons et d'autres machines de réfrigération de taille moyenne et petite.

- 2. 220V-240V / 50-60HZ
- 3. utiliser le réfrigérant R134a
- 4. avec certification CCC / CE / VDE

Compresseurs 220V-240V / 50-60HZ: La série WT se caractérise principalement par une forte capacité de charge, de bonnes performances de démarrage, un faible bruit et une bonne fiabilité La

série WT est dans une structure de bielle et de manivelle entièrement fermée et avec piston alternatif en mode d'aspiration semi-directe

PARAMÈTRE DE PERFORMANCE DU COMPRESSEUR R134a-LBP

		Evap. Température: -23,3 ° C	Cond. Température: 54,4 ° C
Compresseur à faible contre-pression (LBP) Wansheng R134a	Conditions d'essai	Amb. Température: 32,2 ° C	Succion. Température: 32,2 ° C
		Temp de sous-refroidissement: 32,2 LBP ASHRAE ° C	

Modèle	Déplacement (cm³)	Capacité de refroidissement (W)	Puissance nominale (W)	Puissance nominale (HP)	COP (W / W)	Type de moteur	Condensateur (µF)	Relais de départ	Type de refroidissement
--------	-------------------	---------------------------------	------------------------	-------------------------	-------------	----------------	-------------------	------------------	-------------------------

Série WT 220-240V / 50-60Hz

QD75H 7,5      180/200      150/154      1/5      1,2 / RSIR / 1,3      PTC      S

Compresseur de réfrigération série QD R134a (220V-240V / 50Hz)

Modèle	Déplacer (cm3)	Moteur type	Refroidissement type	Capacité							FLIC (W / W)	Moteur contribution (w)	Charge d'huile (cm3)
				-35 °	-30 °	-25 °	-23,3 °	-20 °	-15 °	-23,3 °			
QD25H	2,5	RSIR	S	32	45	58	65	85	105	0,85	76	140	
QD30H	3	RSIR	S	38	53	68	76	98	120	1	76	140	
QD35H	3,5	RSIR	S	45	60	79	88	115	140	1	88	140	
QD43H	4.3	RSIR	S	57	80	103	115	150	185	1.1	105	160	
QD52H	4,9	RSIR	S	68	95	122	136	176	218	1,18	115	160	
QD59H	5.5	RSIR	S	79	110	143	158	205	253	1,3	122	180	
QD65H	6.2	RSIR	S	88	123	158	176	228	280	1,3	135	180	
QD75H	6,6	RSIR	S	98	136	176	195	253	312	1,3	150	180	
QD91H	8.3	RSIR	S / F	115	160	210	230	300	268	1,3	177	180	
QD110H	dix	RSIR	F	145	205	260	290	380	465	1,45	200	220	
QD128H	11,1	RSIR	F	165	230	298	330	430	530	1,43	230	220	
QD142H	13,5	CSIR	F	180	250	325	360	470	580	1,31	275	250	
QD158H	14,8	CSIR	F	195	275	350	390	505	625	1,26	310	250	

<b>Points forts</b>	
Type	Type de LBP
Tension (V)	220
Fréquence (Hz)	50/60
<b>Capacité de refroidissement</b>	
Kcal / h	155/172
W	180/200
Btu / h	614/682
Consommation d'énergie (W)	163/166
Réfrigérant	R134a
<b>Spécifications générales</b>	
Déplacement (CC)	7,0
EER Btu / Wh	3,77 / 4,11
Performance (selon ASHRAE)	ASHARE-23.3°/54.4°@50Hz

HP (50 Hz)	1/5
Déplacement (cm <sup>3</sup> )	7,0
Capacité (W)	180/195
COP (w / w)	1,1 * 1,2
Type de moteur	RSIR
Appareil de démarrage	PTC
Refroidissement	S
Application	R134a LBP
(V / Hz)	220V 50Hz / 60Hz

Compresseur de réfrigérateur 1 / 5HP R134A pour réfrigérateur

Compresseur AC: R134A Hermetic LBP Piston Reciprocationg

Modèle de compresseur : QD75H

Alimentation: 220 ~ 240V / 50Hz

Déplacement: 7.5CC

Capacité de refroidissement: 180W

Puissance nominale: 150W

Puissance nominale: 1 / 5HP

COP: 1,2 W / W

Type de moteur: Relais de  
démarrage RSIR :

Type de refroidissement PTC : S

Application: LBP

Certification: CE

1x20'FCL: 1920PCS

Application:

LBP: Faible contre-pression; Réfrigérateur, congélateur, cave à vin

MBP: Contre-pression moyenne; Climatiseur, distributeur automatique

HBP

:

Contre -pression élevée: Climatiseur, machine à glaçons Condition du test LBP

ASHRAE: Evaporation Température: -23,3 ° C

Température de condensation: 54,4 ° C

Température de sous-refroidissement: 32,2 ° C

Température ambiante: 32,2 ° C

MBP ASHRAE Condition d'essai:

Evaporation Température: -5 ° C

Température de condensation: 54,4 ° C

Température ambiante: 35 ° C

Température de sous-refroidissement: 46,1

Température d'aspiration: 35 ° C

HBP ASHRAE Test condition:

Evaporation Température: 7,2 ° C

Température de condensation: 54,4 ° C

Température ambiante: 35 ° C

Température de sous-refroidissement: 46,1 ° C

Température d'aspiration: 35 ° C

Plage de variation des paramètres:

Capacité de refroidissement:  $\geq 95\%$

Puissance absorbée:  $\leq 115\%$

Courant:  $\leq 110\%$

COP:  $\geq 95\%$

Type de refroidissement:

S: refroidissement naturel

F1: Ventilateur de refroidissement, diamètre du ventilateur 200 mm, vitesse de l'air de 1,5 m / s

F2: Refroidissement du ventilateur, diamètre du ventilateur de 200 mm, vitesse de l'air de 3 m / s



QD75H



220-240V~50/60Hz 1PH

R134a

NO. 2002505



RoHS

CB



CE

Hangzhou Qianjiang Refrigeration Group Co.,Ltd



Private Picture Copyright : [WWW.MBSM.PRO](http://WWW.MBSM.PRO)

COMPRESSEUR, EMBRACO, Refroidi à l'eau, NT2212GKV2, 1-1/2 HP, R-404A, CSCR (cscr), Hermétique, Lbp, 208-230 V

Category: compressor

written by mahdi miled | 7 January 2021



Private Picture Copyright : [WWW.MBSM.PRO](http://WWW.MBSM.PRO)

## Description

5710 BTU Compressor Réfrigération 1.5 HP (208/230V)

### Caractéristiques:

- Compresseurs de remplacement directs pour les appareils Whirlpool, GE et Electrolux
- Compresseurs de remplacement pour l'équipement de restauration, distributeurs automatiques, refroidisseurs de bouteilles, machines à glace et autres équipements de réfrigération
- Configurations de montage supplémentaires sur plaque de base.

Water-Cooled Condensing Unit 1.5 HP, Low Temp, R404A, 220V

Assembled in USA. Unit Equipped With Embraco Compressor NT2212GKV2

One Year Manufacturer's Warranty On Compressor

## Performance

### Données générales

Type	Hermétique réciprocité
Type de technologie	On-Off (On-Off)
Déplacement	27,8 cm <sup>3</sup>
Refroidissement du compresseur	Fan
Flux d'air de ventilateur	31732495.6 in <sup>3</sup> /h
Dispositif d'expansion	Tube capillaire ou valve d'expansion
Puissance du cheval	1 1/2 ch
Fonctionnement de la pression max condensant	24.71 barre
Max Condensing Pic de pression	27.71 barre

Alimentation

208-230 V 60 Hz 1~

Plage de température d'évaporation

-40°F à 14°F

C  
o  
n  
d  
Nouveau : Article neuf, inutilisé, non ouvert et intact  
dans son emballage d'origine (où l'emballage est ... Lire  
la suite

Modèle: **NT2212GKV**

o  
n  
:  
C  
h  
a  
r  
g  
e  
l  
u  
b  
r  
i  
f  
i  
a  
n  
t  
e  
(  
f  
l  
.  
o  
z  
.  
):

Capacité (Btu/h): 5,710

:  
T  
y  
p  
e  
d  
e  
CSCRM(cscr)

Tension d'approvisionnement: 220 V

o  
t  
e  
u  
r  
:  
C  
o  
u  
p  
l  
e  
d  
Couple de départ élevé

Phase de sanction: 1 Phase

d  
é  
p  
a  
r  
t  
:

P  
o  
i  
d  
S  
40.34  
(  
l  
b  
)  
:  
T  
y  
p  
e  
d  
e  
c  
o  
m  
Hermétique  
p  
r  
e  
s  
s  
e  
u  
r  
:  
D  
i  
m  
(  
W  
x  
L  
8.8" x 14.4", 10.6"  
H  
)  
+  
/  
-  
5  
%  
:  
F  
r  
é  
q  
u  
e  
n  
c  
e  
(  
H  
z  
)  
:  
A  
p  
p  
l  
i  
c  
a  
t  
i  
o  
n  
:  
C  
h  
e  
y  
1 1/2  
a  
u  
x  
:

Capa  
cité Moins de 12 000 BTUH  
:

Réfr  
igér R-404a (R-404a)  
ant:

Npp: **925CD02**

Type  
de test ASHRAE32  
:

Desc  
ription  
de la Garantie limitée de 1 an  
gara  
ntie  
:

Dépl  
acem  
ent 1.70  
(cu.  
in):

E  
f  
f  
i  
c  
4.86  
a  
c  
i  
t  
é  
:  
N  
o  
m  
b  
r  
e  
d  
e  
c  
o  
m  
p  
r  
e  
s  
s  
e  
u  
r  
s  
:  
T  
e  
n  
s  
208-230 V  
I  
o  
n  
:

Marque: **Embraco (Embraco)**

Type  
Lubrification: IS022 (en)  
Unit:

Upc: **Ne s'applique pas**

Replaces AHA2465ZXB, AWA2460ZXD, RFT42C1E-PFV, AFJ37C1E-CFV, AFJ37C2E-CFV

External Features

Shape Material Diameter (inch)

Suction Connector VerticalCopper 3/8

Discharge Connector VerticalCopper 1/4

Process Connector VerticalCopper 1/4

Oil Cooler:

Base Plate: Universal

Tray Holder: No

Application

Maximum ambient temperature (°F): 109.4

Expansion device: Capillary/Valve

Cooling: Fan Cooling

Air flow rate:

Mechanical Data

Bore (inch): 1.50

Stroke (inch): 0.48

Electrical Data

Winding Resistance (77°F) – Start: 3.30

Winding Resistance (77°F) – Run: 1.35

Check Point – Condensing Temperature 130 °F

Evaporating Temperature	Cooling Capacity +/-5%			Power Consumption +/-5%	Current Consumption +/-5%	Efficiency +/-7%		
	(kcal/h)	(W)	(Btu/h)	(W)	(A)	(kcal/Wh)	(W/W)	(Btu/Wh)
-10 °F	1,448	1,684	5,745	1.176	5.79	1.23	1.43	4.88

**H.P.** 1 1/2

**Phase** 1

**Hertz** 60

**Torque** HST

**Discharge Size (In.)** 1/4

**Suction Size (In.)** 3/8

**Compressor Capacity** 5,710

**Refrigerant Type** R404A

**Voltage** 208/230

**Foot Mount** Standard Mount: 4.8 x 8

**BTU LT @ -10°F** 5,710

## This Item Replaces

**Tecumseh** AWA2460ZXD

**Copeland** RS86C1E-PFV



Private Picture Copyright: [WWW.MBSM.PRO](http://WWW.MBSM.PRO)

## Description

5710 BTU Compressor Réfrigération 1.5 HP (208/230V)

### Caractéristiques:

- Compresseurs de remplacement directs pour les appareils Whirlpool, GE et Electrolux
- Compresseurs de remplacement pour l'équipement de restauration, distributeurs automatiques, refroidisseurs de bouteilles, machines à glace et autres équipements de réfrigération
- Configurations de montage supplémentaires sur plaque de base.

## Spécifications

<b>Type de produit:</b>	Compresseur	<b>Phase:</b>	1
<b>Capacité (BTU):</b>	5710	<b>Hertz:</b>	60
<b>Puissance du cheval:</b> ⓘ	1-1/2	<b>Type réfrigérant:</b>	R-404A (R-404A)
<b>Tension:</b> ⓘ	208v (208v) 230v 208/230v		

Private Picture Copyright : [WWW.MBSM.PRO](http://WWW.MBSM.PRO)

H.P.	1 1/2
Phase	1
Hertz	60
Torque	HST
Discharge Size (In.)	1/4
Suction Size (In.)	3/8
Compressor Capacity	5,710
Refrigerant Type	R404A
Voltage	208/230
Foot Mount	Standard Mount: 4.8 x 8
BTU LT @ -10°F	5,710

## This Item Replaces

Tecumseh	AWA2460ZXD
Copeland	RS86C1E-PFV

Private Picture Copyright : [WWW.MBSM.PRO](http://WWW.MBSM.PRO)

# Compressor, ZMC, EGM99AZ, 1/4 Hp, 1PH, R134a, LBP, 220-240V 50Hz

Category: compressor

written by [www.mbsm.pro](http://www.mbsm.pro) | 7 January 2021



Private Picture Copyright: [WWW.MBSM.PRO](http://WWW.MBSM.PRO)



Private Picture Copyright: WWW.MBSM.PRO

### General Data

R134a	:Refrigerant
LBP	:Application
30°C to -10°C-	:Evaporating Temperature Range
220/240V/50 HZ	:Voltage/Frequency
Static	:Compressor Cooling
Capillary Tube	:Expansion Device
Multi - 96:120 pcs	:Packaging Quantity
CE-VDE-GOST	:Approvals



Private Picture Copyright: WWW.MBSM.PRO

## Mechanical Data

cm <sup>3</sup> 350	:Oil Charge
ester	:Oil Type Configuration
cSt 19	:Oil Type Viscosity
kg 10.25	:Weight

## Electrical Data

*RSIR / RSCR	:Motor Type
187-264V	:Voltage working range at 50 Hz
130°C	:Maximum Motor Temperature
A 10.19 / 14.49	:Locked Rotor Current
25.08Ω at 25°C	:Start Winding Resistance
Ω at 25°C 7.33	:Run Winding Resistance
ph 1	:Phase



Private Picture Copyright : [WWW.MBSM.PRO](http://WWW.MBSM.PRO)

## External Characteristics

(mm)	Internal Diameter
6.5	Suction Connector
4.9	Discharge Connector
6.5	Process Connector
Copper	Material

## Electrical Components

PTC 14Ω	:Starting Device
T0137/xx	:Motor Protection



Private Picture Copyright : [WWW.MBSM.PRO](http://WWW.MBSM.PRO)

Circuit Diagram for Mod 90 Terminal Board

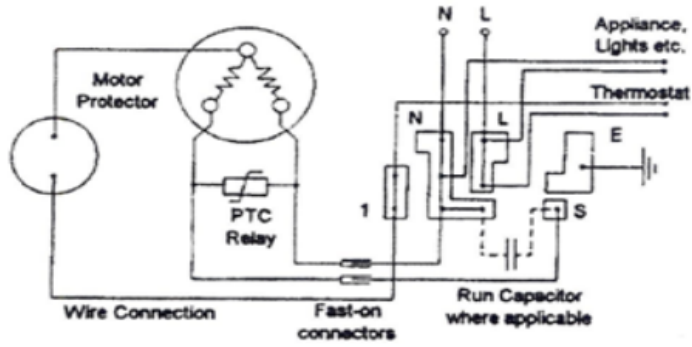

Circuit Diagram for U.H. Terminal Board

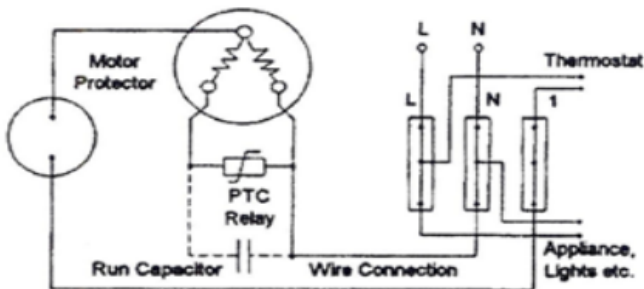

Private Picture Copyright : WWW.MBSM.PRO

PERFORMANCE CURVE DATA:

EGM99AZ

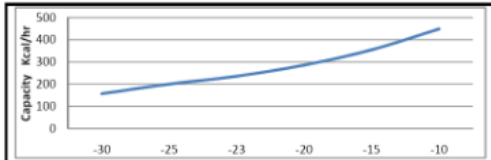

Capacity - Kcal/hr	157	200	236	286	355	449
Evap. Temp. (°C)	-30	-25	-23.3	-20	-15	-10

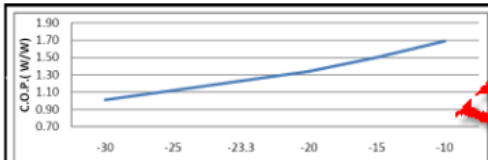

C.O.P. W/W	1.01	1.12	1.23	1.34	1.50	1.69
Evap. Temp. (°C)	-30	-25	-23.3	-20	-15	-10

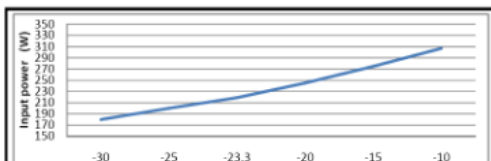

Input power (W)	180	200	219	245	275	307
Evap. Temp. (°C)	-30	-25	-23.3	-20	-15	-10

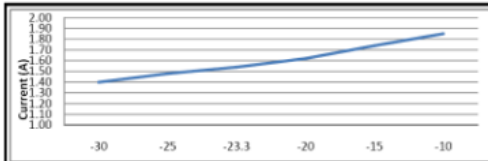

Current (A)	1.40	1.48	1.54	1.62	1.74	1.85
Evap. Temp. (°C)	-30	-25	-23.3	-20	-15	-10

Test Condition: Astrea, Static, Return Gas 32°C Subcooling OK, Evaporating: 23.3°C, Condensing: 55°C, Ambient: 32°C

Private Picture Copyright : WWW.MBSM.PRO



**ZMC**  
**R 134 a**  
**EGM99AZ**

# Compresseur, Secop, GTK80AT, 232W, R134, LBP, 1/4 HP, RSIR, 791 BTU

Category: compressor

written by [www.mbsm.pro](http://www.mbsm.pro) | 7 January 2021



Le compresseur Secop hermétique GTK80AT RSIR est silencieux et dispose d'une large gamme de fonctionnalités utiles. Convient pour une utilisation dans les systèmes de réfrigération domestiques et industriels. Il a une taille compacte

et des performances élevées, une faible consommation d'énergie et une haute qualité. Adapté aux chutes de tension et résiste à de fortes charges.

## Caractéristiques du compresseur Secop GTK80AT

- Fiabilité combinée à une longue durée de vie
- Faible niveau de bruit
- Protection thermique interne du moteur
- Tubes d'acier
- Ressort sur tube à décharge interne

2014 **GTK80AT**

**SECOP**

MADE IN AUSTRIA

200-240V~50Hz

**R134a**





**□ SUCTION ▶**

4 605 0087938 2



EAC **CE**



Compresseur	Réfrigération Q, W	Rendez-vous	Source de courant	Coût, frotter	Disponibilité
 GL99AAb R134a (LBP)	237	Basse température	1 phase / 220 V / 50 Hz	n / a	0 pièces
 GL90AAa R134a (LBP)	223	Basse température	1 phase / 220 V / 50 Hz	4 324,52	5 pièces et plus
 GL90AAb R134a (LBP)	223	Basse température	1 phase / 220 V / 50 Hz	n / a	0 pièces
 GL90ANa	221	Basse température	1 phase / 220 V / 50 Hz	n / a	0 pièces
 GL90ANb	221	Basse température	1 phase / 220 V / 50 Hz	n / a	0 pièces
 GL90ANc	221	Basse température	1 phase / 220 V / 50 Hz	n / a	0 pièces
 GL99AAa R134a (LBP)	237	Basse température	1 phase / 220 V / 50 Hz	4 384,85	5 pièces et plus
 GLY80AAa	221	Basse température	1 phase / 220 V / 50 Hz	n / a	0 pièces
 GLY80AAb	221	Basse température	1 phase / 220 V / 50 Hz	n / a	0 pièces
 HYE81Ya	235	Basse température	1 phase / 220 V / 50 Hz	3 021,23	5 pièces et plus
 NEK1118Z R-134a / LBP / 8,39 cm3	224	Basse température	1 phase / 220 V / 50 Hz	5 917,97	5 pièces et plus
 NEK2117GK	235	Basse température	1 phase / 220 V / 50 Hz	n / a	0 pièces
 NL9F	212	Basse température	1 phase / 220 V / 50 Hz	n / a	0 pièces
 NL9FT (LBP)	220	Basse température	1 phase / 220 V / 50 Hz	5 950,37	5 pièces et plus
 GTK80AT (R134a)	232	Basse température	1 phase / 220 V / 50 Hz	3 650,38	5 pièces et plus
 AE2410Y_FZ1A R134a	240	Basse température	1 phase / 220 V / 50 Hz	n / a	0 pièces
 AE1390Y_FZ1A	214	Basse température	1 phase / 220 V / 50 Hz	n / a	0 pièces



**Model**

Designation **GTK80AT** 200-240V/50Hz 1~ Sales code: **CDO00155**

**Compressor design**

Oil type	Polyolester	Refrigerant(s)	<b>R134a</b>
Oil viscosity	15cSt	Displacement	7,7cm <sup>3</sup> / 0,47cu.in
Oil quantity	156cm <sup>3</sup> / 5,3fl.oz	Compressors on pallet	100
Refr. charge - tech. limit			
Free gas volume comp.	1560cm <sup>3</sup> / 52,7fl.oz		
Weight	9,1kg / 20,1lbs		
Motor protection	external		
Winding resistance main	10,4Ω (at 25°C)		
Winding resistance aux	20,5Ω (at 25°C)		
Max. winding temp.	130°C / 266°F		
Max. discharge temp.	130°C / 266°F		

**General - Configurations with GTK80AT**

	<b>Conf. 1</b>	<b>Conf. 2</b>
Motorconfiguration	RSCR	RSIR
Power supply (nominal)	200-240V/50Hz	200-240V/50Hz
Number of phases	1	1
Voltage range	170-264V	170-264V
Approvals	VDE, EAC	VDE, EAC
Starting torque	LST	LST
Note	- / -	

**Applications with GTK80AT**

	<b>Conf. 1</b>	<b>Conf. 2</b>
Refrigerant	R134a	R134a
Application	LBP	LBP
System cooling	static	static
Hot gas defrost	- / -	- / -
Long interval pull down	- / -	- / -

**Electrical data - Configurations with GTK80AT**

	<b>Conf. 1</b>	<b>Conf. 2</b>
Starting device type	PTC	PTC
Run capacitor	4μF	- / -
Start capacitor	- / -	- / -
LRA (locked rotor amps / 4s)	8,25A	8,25A
RLA (rated load amps / 1s)		
Cut in current	15,5A	15,5A
IP class	21	21

ООО «Промхолд-Ровно»  
 (098) 111-73-73  
 (099) 111-61-63  
 (063) 111-64-63

**Model**

Designation **GTK80AT 200-240V/50Hz** Conf. 1 Sales code: **CDO00155**

**Optimization + standard conditions**

200V/50Hz, RSCR, static, VDE, EAC

	Evaporating pressure (saturation temperature)				Condensing pressure (saturation temperature)			Return gas temp.	Liquid temp.	Cooling capacity	COP	EER	Power consumption			ASHRAE LBP
	pe	pc	RGT	Tliq	[W]	[Btu/h]	[kcal/h]						P1	I	Ref. mass flow	
	[°C]	[°C]	[°C]	[°C]	[W]	[Btu/h]	[kcal/h]	[W/W]	[Btu/Wh]	[kcal/Wh]	[W]	[A]	[kg/h]			
	-23,3	54,4	32,2	32,2	231,5	791	199,2	1,60	5,46	1,38	144,8	0,66	4,49	ASHRAE LBP		
	[°F]															
	-10	130	90	90												
	-25	55	32	55	170,5	582	146,7	1,23	4,19	1,06	138,8	0,63	4,08	cecomaf LBP		
	[°F]															
	-13	131	89,6	131												
	-35	40	20	40	121,3	414	104,4	1,16	3,96	1,00	104,7	0,48	2,66	EN12900 LBP		
	[°F]															
	-31	104	68	104												
	-23,3	48,9	4,44	48,9	190,7	651	164,1	1,35	4,62	1,16	141,1	0,64	5,04	ARI540 LBP		
	[°F]															
	-10	120	40	120												
	-23,3	40,6	32,2	32,2	253,4	865	218,0	1,87	6,39	1,61	135,4	0,66	4,92	AHAM LBP		
	[°F]															
	-10	105	90	90												
	-35	45	32	45	112,9	386	97,2	1,06	3,62	0,91	106,4	0,46	2,44	opt		
	[°F]															
	-31	113	89,6	113												

**Performance tables**

200V/50Hz, RSCR, static, VDE, EAC

	pe	Cooling capacity			COP	EER	P1	I	m		
		[°C]	[°F]	[W]						[Btu/h]	[kcal/h]
[°C / °F]	-35	-31	112,9	386	97,2	1,06	3,62	0,91	106,4	0,46	2,44
cond. pressure	-30	-22	154,5	528	133,0	1,31	4,47	1,13	118,2	0,54	3,34
pc= 45/113	-25	-13	203,5	695	175,2	1,53	5,23	1,32	132,8	0,62	4,41
return gas temp.	-23,3	-10	222,2	759	191,2	1,61	5,48	1,38	138,4	0,65	4,82
RGT= 32/90	-20	-4	261,7	894	225,2	1,75	5,97	1,50	149,7	0,71	5,68
liquid temp	-15	5	330,7	1129	284,6	1,97	6,73	1,70	167,8	0,81	7,21
Tliq= 45/113	-10	14	412,5	1409	355,0	2,21	7,55	1,90	186,6	0,90	9,03
[°C / °F]	-35	-31	85,6	292	73,7	0,80	2,73	0,69	107,1	0,45	2,04
cond. pressure	-30	-22	125,3	428	107,8	1,03	3,53	0,89	121,3	0,53	2,99
pc= 55/131	-25	-13	170,5	582	146,7	1,23	4,19	1,06	138,8	0,63	4,08
return gas temp	-23,3	-10	187,4	640	161,3	1,29	4,40	1,11	145,3	0,66	4,48
RGT= 32/90	-20	-4	222,9	761	191,8	1,41	4,80	1,21	158,6	0,73	5,35
liquid temp	-15	5	284,4	971	244,8	1,58	5,39	1,36	180,0	0,84	6,85
Tliq= 55/131	-10	14	356,8	1218	307,1	1,76	6,02	1,52	202,3	0,95	8,63

Optimization + standard conditions

200-240V/50Hz 1~, RSCR, static, VDE, EAC

		Evaporating pressure (saturation temperature)				Condensing pressure (saturation temperature)			Return gas temp.		Liquid temp.		Cooling capacity			COP	EER	Power consumption			Ref. mass flow m	
pe	pc	RGT	Tliq	[W]	[Btu/h]	[kcal/h]	[W/W]	[Btu/Wh]	[kcal/Wh]	[W]	[A]	[kg/h]			P1	I						
[°C]	[°C]	[°C]	[°C]	[W]	[Btu/h]	[kcal/h]	[W/W]	[Btu/Wh]	[kcal/Wh]	[W]	[A]	[kg/h]			[W]	[A]	[kg/h]					
-23,3	54,4	32,2	32,2	231,5	791	199,2	1,60	5,46	1,38	144,8	0,66	4,49	ASHRAE LBP									
[-10]	130	90	90																			
-25	55	32	55	170,5	582	146,7	1,23	4,19	1,06	138,8	0,63	4,08	cecomaf LBP									
[-13]	131	89,6	131																			
-35	40	20	40	121,3	414	104,4	1,16	3,96	1,00	104,7	0,48	2,66	EN12900 LBP									
[-31]	104	68	104																			
-23,3	48,9	4,44	48,9	190,7	651	164,1	1,35	4,62	1,16	141,1	0,64	5,04	ARI540 LBP									
[-10]	120	40	120																			
-23,3	40,6	32,2	32,2	253,4	865	218,0	1,87	6,39	1,61	135,4	0,66	4,92	AHAM LBP									
[-10]	105	90	90																			
-35	45	32	45	112,9	386	97,2	1,06	3,62	0,91	106,4	0,46	2,44	opt									
[-31]	113	89,6	113																			

Private Picture Copyright : WWW.MBSM.PRO

Compresseur	Réfrigération Q, W	Rendez-vous	Source de courant	Coût, frotter	Disponibilité
<a href="#">cubigel</a> GL99AAb R134a (LBP)	237	Basse température	1 phase / 220 V / 50 Hz	n / a	0 pièces
<a href="#">cubigel</a> GL90AAa R134a (LBP)	223	Basse température	1 phase / 220 V / 50 Hz	4 324,52	5 pièces et plus
<a href="#">cubigel</a> GL90AAb R134a (LBP)	223	Basse température	1 phase / 220 V / 50 Hz	n / a	0 pièce
<a href="#">cubigel</a> GL90ANa	221	Basse température	1 phase / 220 V / 50 Hz	n / a	0 pièces
<a href="#">cubigel</a> GL90ANb	221	Basse température	1 phase / 220 V / 50 Hz	n / a	0 pièces
<a href="#">cubigel</a> GL90ANc	221	Basse température	1 phase / 220 V / 50 Hz	n / a	0 pièces
<a href="#">cubigel</a> GL99AAa R134a (LBP)	237	Basse température	1 phase / 220 V / 50 Hz	4 384,85	5 pièces et plus
<a href="#">cubigel</a> GLY80AAa	221	Basse température	1 phase / 220 V / 50 Hz	n / a	0 pièces
<a href="#">cubigel</a> GLY80AAb	221	Basse température	1 phase / 220 V / 50 Hz	n / a	0 pièces
<a href="#">cubigel</a> HYE81Ya	235	Basse température	1 phase / 220 V / 50 Hz	3 021,23	5 pièces et plus
<a href="#">embraco</a> NEK1118Z R-134a / LBP / 8,39 cm3	224	Basse température	1 phase / 220 V / 50 Hz	5 917,97	5 pièces et plus
<a href="#">embraco</a> NEK2117GK	235	Basse température	1 phase / 220 V / 50 Hz	n / a	0 pièces
<a href="#">SECOP</a> NL9F	212	Basse température	1 phase / 220 V / 50 Hz	n / a	0 pièces
<a href="#">SECOP</a> NL9FT (LBP)	220	Basse température	1 phase / 220 V / 50 Hz	5 950,37	5 pièces et plus
<a href="#">SECOP</a> GTK80AT (R134a)	232	Basse température	1 phase / 220 V / 50 Hz	3 650,38	5 pièces et plus
<a href="#">Kvausok</a> AE2410Y_FZ1A R134a	240	Basse température	1 phase / 220 V / 50 Hz	n / a	0 pièces
<a href="#">Kvausok</a> AE1390Y_FZ1A	214	Basse température	1 phase / 220 V / 50 Hz	n / a	0 pièces

Private Picture Copyright : WWW.MBSM.PRO

Les compresseurs Secop R134a sont excellents pour un usage domestique. Ils sont utilisés non seulement dans les réfrigérateurs ménagers et les congélateurs conventionnels de petit volume, mais aussi dans les équipements des mini-magasins où une source autonome de froid est nécessaire, par exemple:

- vitrines réfrigérées;
- royaux;



– armoires pour le refroidissement des produits laitiers et de l'eau.

Caractéristique:

Puissance frigorifique – 232 W

Réfrigérant – R-134

Compresseur Secop GTK80AT

#### Attributs de base

Pays du fabricant	L'Autriche
Fabricant	Secop (anciennement ACC)

#### caractéristiques supplémentaires

Capacité de refroidissement	231,5
Fréon	R134a
Volume de travail, cm <sup>3</sup>	7,7

## Caractéristique

Fabricant	<b>Secop (Danfoss)</b>
Marque du compresseur	<b>Secop</b>
Modèle	<b>GTK</b>
Type de compresseur	<b>Piston scellé</b>
But du compresseur	<b>Basse température</b>
Régulation des performances	<b>Non</b>
Alimentation du compresseur	<b>1 phase / 220 V / 50 Hz</b>
Plage de puissance frigorifique (EN 12900), kW	<b>0-1</b>
Puissance frigorifique (ASHRAE), kW	0,232
Hauteur, mm	174
Longueur, mm	215
Largeur, mm	151
Poids net / kg	9,1
Quantité d'huile, l	0,156
Niveau sonore, dBA	60
Tuyau de dérivation d'aspiration, mm	6,5
Tuyau de dérivation de refoulement, mm	5.5
Volume du cylindre, cm <sup>3</sup>	7,7
Réfrigérant	R134a

[Mbsm\\_dot\\_pro\\_private\\_PDF\\_GTK80ATTélécharger](#)

[Mbsm\\_dot\\_pro\\_private\\_PDF\\_GTK80AT-1Télécharger](#)

[Mbsm\\_dot\\_pro\\_private\\_PDF\\_GTK80AT-2Télécharger](#)

---

## Samsung, réfrigérateur, MSA150H-L1A, compresseur, R134A, 220-240 V/50Hz, LBP, 1/6 HP, 1/5 HP, 177 w

Category: compressor

written by [www.mbsm.pro](http://www.mbsm.pro) | 7 January 2021

## Détails rapides

N ° de modèle:	MSA150H-L1A
Capacité de refroidissement:	177 W
Réfrigérant:	R134A
Application:	Réfrigérateur
Tension:	220V 60Hz
Marque déposée:	samsung



Private Picture Copyright : WWW.MBSM.PRO



Private Picture Copyright : WWW.MBSM.PRO

Samsung Reciprocating Compressor est un partenaire mondial qui fournit des fonctionnalités durables et respectueuses de l'environnement pour tous vos besoins de refroidissement. Il existe quatre séries de compresseurs à piston: MAS, NC, MSE, MSV

Modèle	moteur	V-Hz	Kcal / heure	Watt	BTU / heure	Watt	Kcal / Wh	W / W	BTU / Wh	AMP
MSA141C-S1A	PTC-RSIR	115-60	121	140	479	98,3	1,23	1,43	4,87	1,35
MSA141C-S1B	PTC-RSCR	115-60	121	140	479	93,5	1,29	1,50	5.13	0,91
MSA143C-S1B	PTC-RSCR	115-60	121	140	479	91,5	1,32	1,53	5,23	0,91
MSA150C-L1A	PTC-RSIR	115-60	148	172	588	119,8	1,24	1,44	4,90	1,63
MSA151C-L1B	PTC-RSCR	115-60	148	172	588	110,0	1,35	1,56	5,34	1,03
MSA151C-L1G	PTC-RSCR	115-60	148	172	588	105,2	1,41	1,64	5,58	0,96
MSA152C-L1G	PTC-RSCR	115-60	148	172	588	102,2	1,45	1,68	5,74	0,93
MSA160C-L1A	PTC-RSIR	115-60	182	212	723	150,9	1,21	1,40	4,79	2.10
MSA161C-L1A	PTC-RSIR	115-60	182	212	723	148,0	1,23	1,43	4,88	2,06
MSA170C-L1B	PTC-RSCR	115-60	214	249	850	155,8	1,38	1,60	5,46	1,65

MSA171C-L1B PTC-RSCR	115-60 214	249	850	157,7	1,36	1,58	5,39	1,65
NC1A30DLA PTC-RSIR	115-60 78	91	309	76,9	1,01	1,18	4,02	1,05
NC1A37DLB PTC-RSCR	115-60 105	122	418	97,4	1,08	1,26	4,29	0,92
NC1A43DLB PTC-RSCR	115-60 117	136	464	98,3	1,19	1,38	4,71	0,94
MSA162D-S1G PTC-RSCR	115-60 182	212	723	129,5	1,41	1,63	5,58	1,39
	127-60 182	212	723	129,5	1,41	1,63	5,58	1,39
NC1A37HLB PTC-RSCR	220-50 88	102	348	81,8	1,07	1,25	4,25	0,50
	220-60 105	122	418	98,2	1,07	1,25	4,25	0,48
NC1A43HLB PTC-RSCR	220-50 93	108	367	83,7	1.10	1,28	4,38	0,52
	220-60 117	136	464	105,8	1.10	1,28	4,38	0,49
MSA141H-L1A PTC-RSIR	220-50 93	109	371	80,8	1,16	1,34	4,59	0,67
	220-60 121	140	479	104,4	1,16	1,34	4,59	0,66
MSA150H-L1A PTC-RSIR	220-50 122	142	483	107,1	1.14	1,32	4,51	0,86
	220-60 148	172	588	130,2	1.14	1,32	4,51	0,81
MSA160H-L1A PTC-RSIR	220-50 147	171	584	132,4	1.11	1,29	4,41	1.12
	220-60 182	212	723	164,0	1.11	1,29	4,41	1,02
MSA161H-L1A PTC-RSIR	220-50 147	171	584	131,5	1.12	1,30	4,44	1.10
	220-60 182	212	723	162,8	1.12	1,30	4,44	1,00
MSA170H-L1B PTC-RSCR	220-50 168	196	669	137,3	1,23	1,43	4,87	0,81
	220-60 214	249	850	174,6	1,23	1,43	4,87	0,72
MSA170H-L1G PTC-RSCR	220-50 168	196	669	124,6	1,35	1,57	5,36	0,73
	220-60 214	249	850	158,5	1,35	1,57	5,36	0,73
MSA171H-L1B PTC-RSCR	220-50 168	196	669	138,3	1,22	1,42	4,83	0,78
	220-60 214	249	850	175,8	1,22	1,42	4,83	0,76
NC1A37BLA PTC-RSIR	220-60 105	122	418	100,3	1,05	1,22	4.16	0,70
MSA162B-L1G PTC-RSCR	220-60 182	212	723	126,6	1,44	1,67	5,71	0,60
NC1A30GLA PTC-RSIR	220-50 66	77	263	69,1	0,96	1.11	3,80	0,59
	220-60 78	91	309	81,3	0,96	1.11	3,80	0,54
MSA151G-L1B PTC-RSCR	220-50 120	139	475	91,5	1,31	1,52	5,19	0,50
	220-60 148	172	588	113,1	1,31	1,52	5,19	0,50
MSA162G-L1B PTC-RSCR	220-50 147	176	599	112,0	1,31	1,53	5,21	0,70
	220-60 182	217	742	138,7	1,31	1,53	5,21	0,67
NC1A37QLB PTC-RSCR	220-50 88	102	348	77,9	1.13	1,31	4,46	0,43
MSA141Q-S1A PTC-RSIR	220-50 93	109	371	80,8	1,16	1,34	4,59	0,67
MSA150Q-L1A PTC-RSIR	220-50 122	142	483	101,3	1,20	1,40	4,77	0,71
	240-50 122	142	483	101,3	1,20	1,40	4,77	0,74
MSA153Q-L1A PTC-RSIR	220-50 122	142	483	108,1	1.13	1,31	4,47	0,78
	240-50 122	142	483	108,1	1.13	1,31	4,47	0,82
MSA160Q-L1A PTC-RSIR	220-50 147	171	584	122,7	1,20	1,39	4,76	0,87
	240-50 147	171	584	122,7	1,20	1,39	4,76	0,91
MSA161Q-L1A PTC-RSIR	220-50 147	171	584	118,8	1,24	1,44	4,91	0,86
	240-50 147	171	584	118,8	1,24	1,44	4,91	0,90
MSA161Q-L1B PTC-RSCR	220-50 147	171	584	113,0	1,30	1,51	5,17	0,65
	240-50 147	171	584	113,0	1,30	1,51	5,17	0,65
MSA162Q-L1G PTC-RSCR	220-50 147	171	584	103,2	1,42	1,66	5,65	0,48

MSA163Q-L1A PTC-RSIR	220-50	147	171	584	130,5	1.13	1,31	4,47	0,94
	240-50	147	171	584	130,5	1.13	1,31	4,47	1,02
MSA170Q-L1B PTC-RSCR	220-50	168	196	669	125,6	1,34	1,56	5,32	0,61
MSA170Q-L1G PTC-RSCR	220-50	168	196	669	119,8	1,41	1,64	5,58	0,58
MSA171Q-L1B PTC-RSCR	220-50	168	196	669	127,6	1,32	1,54	5,24	0,63
NC1A43KLB PTC-RSCR	220-50	93	108	367	81,8	1.13	1,32	4,49	0,46
MSA141K-L1A PTC-RSIR	220-50	93	109	371	83,7	1.12	1,30	4,43	0,65
MSA141K-S1A PTC-RSIR	220-50	93	109	371	80,8	1,16	1,34	4,59	0,67
MSA141K-S1B PTC-RSCR	220-50	93	109	371	76,9	1,22	1,41	4,82	0,44
MSA143K-S1B PTC-RSCR	220-50	93	109	371	75,0	1,25	1,45	4,95	0,45
MSA151K-S1G PTC-RSCR	220-50	122	142	483	99,3	1,23	1,42	4,86	0,57
MSA162K-S1G PTC-RSCR	220-50	147	171	584	113,9	1,29	1,50	5.12	0,62
MSA170K-S1G PTC-RSCR	220-50	168	196	669	128,5	1,31	1,52	5.20	0,73
MSA150E-L1A PTC-RSIR	100-50	122	142	483	109,1	1.12	1,30	4,43	1,88
	100-60	148	172	588	132,6	1.12	1,30	4,43	1,80
MSA160E-L1A PTC-RSIR	100-50	147	171	584	135,4	1,09	1,26	4,31	2,45
	100-60	182	212	723	167,6	1,09	1,26	4,31	2,25
MSA162P-S1B PTC-RSCR	127-60	182	217	742	133,4	1,36	1,59	5,42	1,17

Model	Motor Type	Voltage [V-Hz]	Cooling Capacity			Power Input W	Efficiency			Cooling Type
			kcal/Hr	Watt	BTU/Hr		EFF Kcal/WHr	COP W/W	EER BTU/WHr	
CD124Q-L1Z2	RSIR	220-50	43	50	171	57	0.75	0.88	2.99	ST
CD130Q-L1Z2	RSIR	220-50	58	67	230	65	0.89	1.04	3.54	ST
CD130Q-S1ZA	RSIR	220-50	58	67	230	74	0.78	0.91	3.11	ST
SD137Q-L1ZB	RSIR	220-50	75	87	298	86	0.87	1.01	3.46	ST
SD137Q-L1UB	RSCR	220-50	75	87	298	80	0.94	1.09	3.72	ST
SD143Q-L1U2	RSCR	220-50	95	110	377	99	0.96	1.12	3.81	ST
MSA143Q-S1Z	RSIR	220-50	96	112	381	83	1.16	1.34	4.59	ST
SD152Q-L1UB	RSCR	220-50	120	140	476	104	1.15	1.34	4.58	ST
MD152Q-L1U2	RSCR	220-50	118	137	468	98	1.2	1.4	4.78	ST
SD162Q-L1UB	RSCR	220-50	146	170	580	125	1.17	1.36	4.64	ST
MK162Q-L1UA	RSCR	220-50	145	169	576	105	1.38	1.61	5.48	ST
MSS162Q-L1U	RSCR	220-50	151	176	599	105	1.44	1.67	5.71	ST
MSA162Q-L1G	RSCR	220-50	151	176	599	111	1.36	1.58	5.4	ST
SK170Q-L1U	RSCR	220-50	168	195	667	141	1.19	1.39	4.73	ST/OC
MSA170Q-L1B	RSCR	220-50	173	201	687	129	1.34	1.56	5.32	ST
MSA170Q-L1G	RSCR	220-50	173	201	687	126	1.37	1.6	5.45	ST
MK172Q-L2UB	RSCR	220-50	176	205	699	129	1.36	1.59	5.42	FC
SK182Q-L2U	RSCR	220-50	203	236	806	164	1.24	1.44	4.91	FC/OC
MK183Q-L2UB	RSCR	220-50	203	236	806	142	1.43	1.66	5.68	FC
SK190Q-L2U	RSCR	220-50	227	264	901	180	1.26	1.47	5.01	FC/OC
MK190Q-L2U	RSCR	220-50	225	262	893	157	1.43	1.67	5.69	FC
SK1A1Q-L2UB	RSCR	220-50	275	320	1092	229	1.2	1.4	4.77	FC
NC1A37QLB	RSCR	220-50	90	105	357	80	1.13	1.31	4.47	ST

Cooling Type	Motor Type	ASHRAE Conditions (LBP)	Unit Conversion Table
FC : Fan cooling	RSIR : Resistance Start Induction Run	Evaporating Temp. : -23.3°C (-10°F)	1 watt = 3.41 Btu/Hr
OC : Oil cooling	RSCR : Resistance Start Capacitor Run	Condensing Temp. : 54.4°C (130°F)	1 watt = 0.86 Kcal/Hr
ST : Static	CSIR : Capacitor Start Induction Run	Gas Superheated to : 32.2°C (90°F)	1 Kcal/Hr = 3.97 Btu/Hr
	CSR : Capacitor Start Capacitor Run	Liquid sub-cooled to : 32.2°C (90°F)	
		Ambient Temp. : 32.2°C (90°F)	



## Détails rapides

N ° de modèle: MSA150H-L1A  
 Capacité de refroidissement: 177 W  
 Réfrigérant: R134A  
 Application: Réfrigérateur  
 Tension: 220V 60Hz  
 Marque déposée: samsung



Private Picture Copyright: WWW.MBSM.PRO

Tension	Modèle	Type de moteur	Capacité de refroidissement / w (50Hz)	Capacité de refroidissement / w (60Hz)	Entrée / w (50Hz)	Entrée / w (60Hz)	COP (50 Hz)	COP (60 Hz)
200-220v 50Hz 220V 60Hz	MSA141H-L1A	RSIR	112	144	88	103	1,27	1,40
	MSA150H-L1A	RSIR	145	177	110	123	1,32	1,44
	MSA160H-L1A	RSIR	176	217	136	150	1,29	1,45
	MSA171H-L1B	RSCR	201	256	142	161	1,42	1,59
220-240V 50Hz	MSA151G-L1B	RSCR	143	177	94	110	1,52	1,61
220V 60Hz	MSA162G-L1B	RSCR	176	217	115	135	1,5	1,61

Private Picture Copyright: WWW.MBSM.PRO

RATED VOLTAGE	MODEL	MOTOR TYPE	VOLTAGE [V-Hz]	ASHRAE							COOLING TYPE
				COOLING CAPACITY			POWER INPUT	EFFICIENCY			
				kcal/h	Watts	Btu/h		Watts	EFF	COP	
AC 200-220V-50Hz, 220V-60Hz	MSA141H-L1A	RSIR	220-50	96	112	381	83	1.16	1.34	4.59	ST
			220-60	124	144	492	103	1.20	1.40	4.78	
	MSA143H-L1A	RSIR	220-50	95	110	377	85	1.12	1.30	4.43	ST
			220-60	128	149	508	102	1.25	1.46	5.00	
	MSA150H-L1A	RSIR	220-50	125	145	496	110	1.14	1.32	4.51	ST
			220-60	152	177	603	123	1.24	1.44	4.90	
	MSA151H-L1A	RSIR	220-50	128	149	508	107	1.20	1.39	4.75	ST
			220-60	152	177	603	121	1.26	1.46	5.00	
	MSA160H-L1A	RSIR	220-50	151	176	599	136	1.11	1.29	4.41	ST
			220-60	187	217	742	150	1.25	1.45	4.95	
	MSA161H-L1A	RSIR	220-50	151	176	599	135	1.12	1.30	4.44	ST
			220-60	187	217	742	149	1.26	1.46	4.98	
	MSA162H-L1A	RSIR	220-50	152	177	603	141	1.08	1.25	4.28	ST
			220-60	192	223	762	153	1.25	1.46	5.00	
	MSA162H-L1H	RSCR	220-50	152	177	603	110	1.38	1.61	5.50	ST
			220-60	192	223	762	134	1.43	1.67	5.70	
	MSA171H-L1B	RSCR	220-50	173	201	687	142	1.22	1.42	4.83	ST
			220-60	220	256	873	161	1.37	1.59	5.42	

Private Picture Copyright : WWW.MBSM.PRO



Private Picture Copyright : WWW.MBSM.PRO

Mbsm\_dot\_pro\_private\_PDF\_SAMSUNG-COMPRESSOR-2020Télécharger

EMX66CTC, Embraco, compresseurs,  
183w, 240v / 50 1/4 HP, R600A,  
hermétiques, HVAC, + Ptc, Alu,  
Hotpoint, Indesit, Whirlpool, LBP,

# Cylindrée (cm<sup>3</sup>)10,61

Category: compressor

written by [www.mbsm.pro](http://www.mbsm.pro) | 7 January 2021



Private Picture Copyright : [WWW.MBSM.PRO](http://WWW.MBSM.PRO)

catégorie de produit

Compresseurs de réfrigération et compresseurs de climatisation

Capacité

0,14 kW (0,1840 ch)

Évaluation du réfrigérant

R-600a

EER

1,18

Source d'énergie

230/50/1

Options de réfrigérant

R-600a

Ce produit est compatible avec les modèles suivants : RSZ 3032 V L BSZ 3032 V BAAAAN 10 SBL 2031 V/HA UPS 1721 F/HA UFAAN 400 NF UPS 1721 F J/HA UPS 1721 F J/HA UPS 1722 F J/HA CAA 55 BAAAAN 12 SBL 2030 V/HA IUPS 1722 F J IUPS 1722 F J IUPS 1721 F J EXFL 2010 P FFFL 2010 K EXFL 2010 G SBL 203A V CAA 55 NX BIAAA 12 NCAA 55 NCAA 55 NX BIAAA 10 X BIAAA 10 UIAA 12 F UIAA 22 Y UIAA 12 F R (UK) UIAA 10 F EBYH 20320 V EBL 20311 V EBL 20321 V EBLH 18311 V 03 EBYH 18321 V NCAA 55 (UK) CAA 55 (UK) CAA 55 K (UK) CAA 55 S (UK) UPSY 1721 F J UPSY 1722 F J FZFM 151 G FZFM 151 P FZFM 171 P FZFM 171 G HSZ3022VL HSZ3022VL BIAA 33 F SI Y BIAA 33 F X H Y RFAA52P RFAA52S RFAA52K EBYH 18242 F EBYH 18242 F EBYH 18201 F EBYH 18201 F UIA 12 (EX) UIA 12 S (EX) FFUL 2012 P FFUL 2012 X FFUL 2012 X BIAAA 12 X

HM325NI IN C 325 AA UK STF200WP NCAA 55 S (UK) EBYH 18213 F 03 H 18223 F 03 EBYH 18223 F 03 STF200WG FUFL 2010 P EBLH 18301 V 03 FZFM 171 SB NBIAAA 10 NRFAA50S NRFAA50P EBMH 17321 NX NCAA 55 K UK CAA 55 NX UK FFFL 2013 P (03) FFFL 2013 P (03) FFFL 2013 X L 2013 X (03) EBY 18211 F BIAAA 12 UK IUPSY 1722 F J DBIAA 344 F UK UPS 1521.1 RZFM 151 P.1 RZFM 151 G.1 UPS 1521 (TK).1 FFUL 2012 G UIAA 10 (TK).1 UIAA 12 S.1 NUIAA 12.1 UIAA 12 S (UK).1 UIAA 10 S.1 UIAA 12.1 UIAA 12.1 UIAA 10. 12 (UK).1 UIAA 10 (UK).1 UIAA 10.1 BCZ L 400 X (BI)/HA HTF200WP HTF200WG UPS 1746.1 T IN C 425 AA UK FFFL 2012 P FFFL 2012 G AFAA 52 P AI AFAA 52 K AI AFAA 52 S AI CAA 55 S NCAA 55 K EBYH 18242 D F YH 18242 D F ECORM 172 P ECOFL 2010 G ECOFL 2010 G ECOFL 2010 P ECOFL 2010 P BIAAA 12P X NBIAAA 10P BIAAA 12P BIAAA 10P X BIAAA 12P UK BIAAA 10P HM325NI AI UPS 1521 F (TK) NEBYH 18242 F UIAA 12 F I X UX UIX UIX IAA 12 F I UPSI 1721 F/HA UPSI 1721 F (TK)/HA UPSI 1722 F J/HA UPSI 1722 J FSFL 2010 P FZFI 171 G FZFI 171 P UPSO 1722 F J UPSO 1721 F J IUPSO 1721 F J et plus.



COOLING CAPACITY CECDMAF																	
CONDENSING TEMPERATURE °C	EVAPORATING TEMPERATURE °C						WEIGHT kg	MAX HEIGHT A mm	LRA A	COOLING TYPE	FAN AIR FLOW m³/h	OIL		EXP DEVICE	DRAWINGS		MODEL
	-30	-25	-20	-15	-10	-5						CHARGE cm³	TYPE		EXTERNAL VIEW REFERENCE	WIRING DIAGRAM REFERENCE	
55	36	49	64	82	102	126	7,1	166	2,1	S	-	150	AB 5	C	DWG01	SM01	EMX20CLC
45	44	58	76	96	119	146											
55	43	59	80	104	133	165	7,1	166	-	S	-	150	AB 5	C	DWG01	SM01	EMX26CLC
45	53	72	96	124	156	192											
55	49	69	92	119	151	189	7,3	166	3,3	S	-	150	AB 5	C	DWG01	SM01	EMX32CLC
45	64	86	111	141	176	218											
55	-	-	-	-	-	-	7,7	171	6,8	S/F	270	150	AB 5	C/V	DWG01	SM00-SM01	EMX3109Y
45	-	-	-	-	-	-											
55	78	107	142	187	233	260	7,7	171	3,4	S	-	150	AB 5	C	DWG01	SM02	EMC40CLT
45	88	118	154	198	248	300											
55	88	119	158	203	256	280	7,1	166	-	S	-	150	AB 2	C	DWG01	SM02	EMC46CLT
45	95	129	169	215	269	310											
55	-	-	-	-	-	-	8	171	11,6	S/F	270	150	AB 5	C/V	DWG01	SM01	EMX3113Y
45	-	-	-	-	-	-											
55	87	117	154	197	245	303	7,6	166	-	S	-	150	AB 5	C	DWG01	SM01	EMX55CLC
45	102	135	175	222	277	339											
55	-	-	-	-	-	-	7,7	166	14,1	S/F	270	150	AB 5	C/V	DWG01	SM01	EMX3115Y
45	-	-	-	-	-	-											
55	101	137	178	227	284	348	7,4	166	6,4	S	-	150	AB 5	C	DWG01	SM01	EMX66CLC
45	122	160	207	261	323	394											
55	103	143	184	233	290	360	7,4	166	6	S	-	150	AB 5	C	DWG01	SM01	EMX70CLC
45	123	164	210	263	327	403											
55	-	-	-	-	-	-	7,7	166	14,1	S/F	270	150	AB 5	C/V	DWG01	SM01	EMX3118Y
45	-	-	-	-	-	-											
55	-	-	-	-	-	-	7,7	171	7,8	S/F	270	150	AB 5	C/V	DWG01	SM00	EMY3118Y

Private Picture Copyright : [WWW.MBSM.PRO](http://WWW.MBSM.PRO)

MODEL	DISPL. cm³	HP	VOLTAGE/FREQUENCY	MOTOR TYPE	TORQUE	APPLICATION	RATED POINT - ASHRAE -23,3 °C / 54,4 °C		RATED POINT - CECDMAF -25 °C / 55 °C		CONDENSING TEMPERATURE °C	EVAPORATING		
							CAPACITY W	EFFICIENCY W/W	CAPACITY W	EFFICIENCY W/W		-30	-25	-20
EMX20CLC	4,0	1/14	220-240V 50Hz 1 -	RSCR	LST	LBP	63	1,66	48	1,3	55	36	49	64
											45	44	58	76
EMX26CLC	5,2	1/12	220-240V 50Hz 1 -	RSCR	LST	LBP	81	1,68	60	1,32	55	43	59	80
											45	53	72	96
EMX32CLC	6,0	1/10	220-240V 50Hz 1 -	RSCR	LST	LBP	92	1,72	69	1,35	55	49	69	90
											45	64	86	111
EMX3109Y	6,2	1/10	100V 50Hz / 100-127V 60Hz 1 -	RSIR/RSCR	LST	L/MBP	100	1,68	-	-	55	-	-	-
											45	-	-	-
EMC40CLT	7,2	1/8	220-240V 50Hz 1 -	RSCR	LST	LBP	117	1,79	87	1,4	55	78	107	142
											45	88	118	154
EMC46CLT	8,0	1/7	220-240V 50Hz 1 -	RSCR	LST	LBP	133	1,8	98	1,37	55	88	119	158
											45	95	129	169
EMX3113Y	9,0	1/7	100V 50Hz / 100-127V 60Hz 1 -	RSCR	LST	L/MBP	155	1,75	-	-	55	-	-	-
											45	-	-	-
EMX55CLC	9,0	1/6	220-240V 50Hz 1 -	RSCR	LST	LBP	156	1,74	117	1,37	55	87	117	154
											45	102	135	175
EMX3115Y	10,6	1/5	100V 50Hz / 100-127V 60Hz 1 -	RSCR	LST	L/MBP	184	1,67	-	-	55	-	-	-
											45	-	-	-
EMX66CLC	10,6	1/5	220-240V 50Hz 1 -	RSCR	LST	LBP	183	1,73	137	1,37	55	101	137	178
											45	122	160	207
EMX70CLC	11,1	1/5	220-240V 50Hz 1 -	RSCR	LST	LBP	191	1,71	143	1,34	55	103	143	184
											45	123	164	210
EMX3118Y	12,2	1/5	100V 50Hz / 100-127V 60Hz 1 -	RSCR	LST	L/MBP	212	1,66	-	-	55	-	-	-
											45	-	-	-
EMY3118Y	12,2	1/5	220-240V 50Hz 1 -	RSIR	LST	L/MBP	212	1,49	157	1,16	55	-	-	-
											45	-	-	-
EMY3118Y	12,2	1/5	220-240V 50Hz 1 -	RSCR	LST	L/MBP	213	1,58	158	1,23	55	-	-	-
											45	-	-	-
EMX3118Y	12,2	1/5	220-240V 50Hz 1 -	RSCR	LST	L/MBP	214	1,72	159	1,34	55	-	-	-
											45	-	-	-

Private Picture Copyright : [WWW.MBSM.PRO](http://WWW.MBSM.PRO)

Mbsm\_dot\_pro\_private\_PDF\_emx66clc-1-embraco-compressors-10-2019Télécharger  
Mbsm\_dot\_pro\_private\_PDF\_emx66clc-2-embraco-compressors-10-2019Télécharger

# COMPRESSEUR, RÉFRIGÉRATION, 1/5 HP,

# ZR57AA, RSCR, Condensateur Run, LBP, 166 W, R134a

Category: compressor

written by [www.mbsm.pro](http://www.mbsm.pro) | 7 January 2021



Private Picture Copyright : [WWW.MBSM.PRO](http://WWW.MBSM.PRO)

Modèle ZR57AA (1 / 5HP)

## Caractéristiques

Type de moteur	RSCR (Condensateur Run) LBP
Volt	220 à 240 V, 50 Hz
Capacité de refroidissement	166 W
FLIC	1,48
La puissance d'entrée	112 W
Courant évalué	0,62 ampères
Réfrigérant	R134a



Private Picture Copyright : [WWW.MBSM.PRO](http://WWW.MBSM.PRO)



Private Picture Copyright : [WWW.MBSM.PRO](http://WWW.MBSM.PRO)



Private Picture Copyright : [WWW.MBSM.PRO](http://WWW.MBSM.PRO)



Private Picture Copyright : [WWW.MBSM.PRO](http://WWW.MBSM.PRO)



Private Picture Copyright : [WWW.MBSM.PRO](http://WWW.MBSM.PRO)

Mbsm\_dot\_pro\_private\_PDF\_ZR57AATélécharger

## 1/5 HP Zero Refrigeration Compressor

Model ZR57AA (1/5HP)

### Specifications

Motor Type RSCR (Capacitor run) LBP  
Volt 220-240V, 50Hz  
Cooling Capacity 166W  
COP 1,48  
Input Power 112W  
Rated Current 0,62 Amps  
Refrigerant R134a

\*\*\*Each unit is securely packaged in a sealed box\*\*



### Fitment Parts Supplied With Each Unit



Partlist	Model/Spec	Qty
Relay Cover		1
Relay Cover Clip		1
Earth Screw	M4 x 8	1
Rubber Grommet		4
Sleeve		4
Washer		4
Screw	M6 x 30	4
Hexagon Nut	M6	4
Motor Protector	BT64-120A61D3	1
PTC Relay	QP2-15EC	1
Capacitor	4uf	1