

ENIEM Refrigerateur, no-frost, Made in Algeria, 540L, 220v-240v/50hz, Inverter, Compressor , Technology , Refrigerator LG, bsa090njmv, Inverter, Small Compressor, 9.8 cc , r600a, 60G, Block dc control inverter

Category: compressor

written by www.mbsm.pro | 11 January 2021



Private Picture Copyright : WWW.MBSM.PRO

ENIEM Refrigerateur, Made in Algeria, 540L, 220v-240v/50hz, Inverter, Compressor , Technology , Refrigerator LG, bsa090njmv, Inverter, Small Compressor, 9.8 cc , r600a, Block dc control inverter



Private Picture Copyright : WWW.MBSM.PRO

Nomenclature

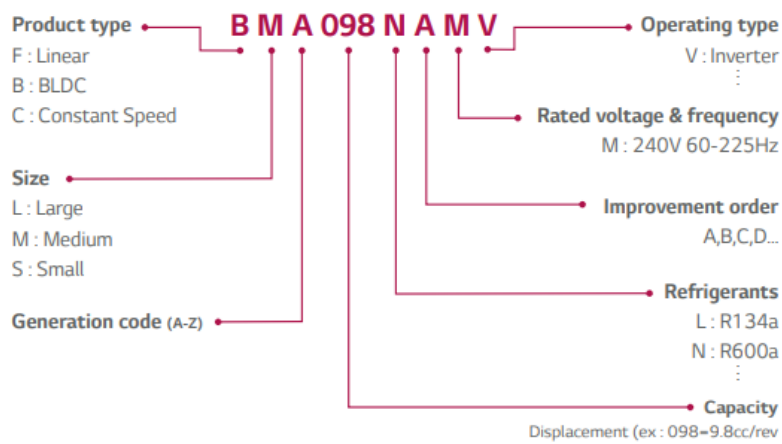

Wide operating range

- New oil pumping system
- 1,200-4,500rpm

Private Picture Copyright : WWW.MBSM.PRO



ENIEM

م و ص ك م



MADE IN ALGERIA

صنع في الجزائر

Réfrigérateur No-Frost

Volume total brut

0

0

F

N° 5

ALGERIE

TN2000

540 L

220V-240V/50Hz

1.09 Kwh/24h

ثلاجة بدون جنيد

الحجم الإجمالي

الكابسة

استهلاك الطاقة

ماتع التبريد

الرقم التسلسلي

ALGERIE

ش. ذ. أ. م و ص ك م، المنطقة الصناعية عمس - الجزائر 108

MT



Private Picture Copyright: WWW.MBSM.PRO

Mbsm_dot_pro_private_PDF_bsa090njmv-

Inverter_Compressor_Technology_for_RefrigeratorReciprocatingTélécharger

Compressor, ASPERA, b3118b , 1/4 hp ,
240V~50hZ, Frigidaire 2 portes,
Philips, 180W, Class T, 422L (460L
Total), compressor b3118b, 220g ,
R134a

Category: compressor,Non classé

written by www.mbsm.pro | 11 January 2021



PHILIPS

MADE IN EGYPT

Service
Service
Service

MODEL ARG 425 / PH

230 V - 50 Hz

Class T

Gross Volume	460	Ltr
Net Volume	440	Ltr
Net Storing Volume	422.5	Ltr
System Compressor	ccl ₂ F ₂ 220 g	

1000000000

Compressor, ASPERA, b3118b , 1/4 hp , 240V~50hZ, Frigidaire 2 portes, Philips, 180W, Class T, 422L (460L Total), compressor b3118b, 220g , R134a



PHILIPS

MADE IN EGYPT

Service
Service
Service
230 V
50 Hz
180 W

MODEL ARG 425 / PH

Class T

Gross Volume	460	Ltr
Net Volume	440	Ltr
Net Storing Volume	422.5	Ltr
System Compressor	ccl ₂ F ₂ 220 g	

1000000000

4.30 BAJA TEMPERATURA, Monofásicos 220 V 50 Hz

R12
MP39
FX56

Modelo	Tipo	CV.	Cm3	Código	Precio €
BP1084A	S	1/8	4,30	10600	-
BP1111A	S	1/8	5,73	10601	139,00
NB1112A	S	1/6	5,9	10602	167,00
NB1116A	S	1/4	8	10603	161,00
B3116B	RH	1/4	8	10604	166,00
NB1118A	S	1/4	8,85	10605	165,00
B3118B	RH	1/4	8,85	10606	172,00
B2118B	S	1/4	8,85	10607	181,00

Modelo	Tipo	CV.	Cm3	Código	Precio €
NE2121A	F	1/3	12,00	10608	210,00
T2124A	F	1/3	12,58	10609	-
T2128A	F	1/3	14,50	10610	-
NE2130A	F	1/3	14,20	10611	236,00
T2134A	F	3/8	17,40	10612	310,00
T2140A	F	3/8	20,40	10613	321,00
J2152A	F	1/2	26,00	10614	439,00
J2170A	F	3/4	34,37	10615	462,00

Ver aplicación de todos los compresores de esta página en el nuevo reglamento Europeo (CE) nº 2037/2000, publicado el 29/09/2000.

4.40 BAJA TEMPERATURA, Monofásicos 220 V 50 Hz

R22
R417a
R427a

Modelo	Tipo	CV.	Cm3	Código	Precio €
NE2125E	F	1/3	8,90	10618	199,00
NE2134E	F	3/8	12,00	10619	217,00
T2140E	F	1/2	14,50	10620	339,00
T2155E	F	5/8	17,40	10621	362,00

Modelo	Tipo	CV.	Cm3	Código	Precio €
T2168E	F	3/4	20,40	10622	373,00
NJ2178E	F	3/4	23,50	10623	413,00
J2190E	F	3/4	27,10	10624	429,00





Private Picture Copyright: WWW.MBSM.PRO



QBH57C10GPX, 1/6HP ,RSIR,
Compressors, R134a (160g), LBP
,PANASONIC Congélateur Electrostar
Defrost, 5 tiroirs , blanc ,
Electrostar, ES215DF, 188L (total
215L), 144W, 1.1A, 220-240v-50hz

Category: compressor

written by www.mbsm.pro | 11 January 2021



QBH57C10GPX, 1/6HP ,RSIR, Compressors, R134a (160g), LBP ,PANASONIC Congélateur Electrostar Defrost, 5 tiroirs , blanc , Electrostar, ES215DF, 188L (total 215L), 144W, 1.1A, 220-240v-50hz,





Certains types de réfrigérateurs Panasonic An Khang fournissent:

>> Réfrigérateur Panasonic SFJ39C72RLW - 1 / 9HP - 220 ~ 240V - R134.

>> Panasonic SFJ48C87RLW Tornado - 1 / 7HP - 2240VAC - R134.

>> Réfrigérateur Panasonic QBH57C10GPX - 1 / 6HP - 2240VAC - R134.

>> Réfrigérateurs Panasonic QBH66C13GPX - 1 / 5HP - 2240VAC - R134.

>> Réfrigérateurs Panasonic QBH73C16GPX - 1 / 5HP - 2240VAC - R134.

>> Réfrigérateur Panasonic QBH86C19RPX - 1 / 4HP - 2240VAC - R134.

>> Réfrigérateur Panasonic QB110C19GAW5-1 / 3HP - 220 ~ 240V - R134.

En outre, notre société propose également d'autres types de compresseurs

Picture5 Mbsm Dot Pro : www.mbsm.pro

Private Picture Copyright: WWW.MBSM.PRO







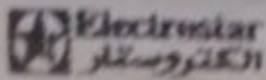

Made in Egypt

Up-Right-DeepFreezer

Model **ES 215 DF** طراز

Voltage **220-240 V ~ 50 HZ** **1.1A** **144 W**

Freezing Capacity 18 Kg/24Hr Freezer Storage Volume 198 Lit.

Total Gross Volume 215 Lit.



168515

R134a **160g** وزن وسيط

التبريد

Class T صنع في مصر

max. lamp input	Without	15 W
Protection Rating	IPX 4	
According To	ES 6000 / 2008 - ISO 15502 / 2005	





Wiring Diagram For Defrost Freezers

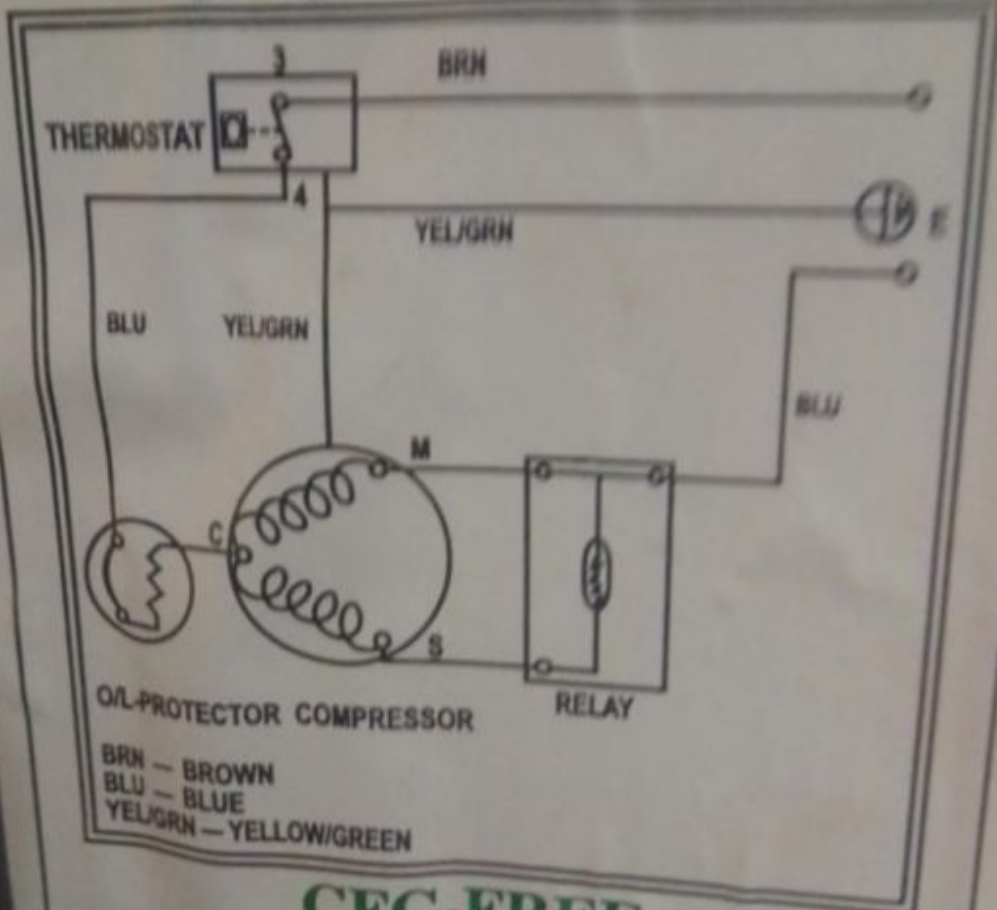

OIL-PROTECTOR COMPRESSOR

BRN - BROWN
BLU - BLUE
YEL/GRN - YELLOW/GREEN

CFC-FREE
REFRIGERANT : 134a
FOAM : C-PENTANE





Panasonic R134a



911493 8025 MP3323061

QBH57C10GPX 1PH

220V-50Hz

Thermally Protected
Panasonic Corporation
Made in Malaysia

W



Kulthorn, compressor, Kulthorn compressor, c-qn76l6f, c-qn76l6f-l, 1/10 Hp, 1Ph, Serie C-q, R134a, 76 watt, Low back pressure, 200-220V/50hz, 220v/60hz, Compressor modéfier

Category: compressor

written by www.mbsm.pro | 11 January 2021



Private Picture Copyright : WWW.MBSM.PRO

Kulthorn, compressor, Kulthorn compressor, c-qn76l6f, 1/10 Hp, 1Ph, Serie C-q, R134a, 76 watt, Low back pressure, 200-220V/50hz, 220v/60hz, Compressor modéfier
Compressor Motor Protectors

Each compressor incorporates a motor protection device or system. Generally, the larger the compressor, the more sophisticated the motor protector.

It is essential that an electric motor is protected against conditions that could

otherwise result in damage to the motor or to the electrical supply system. For this

reason, every Kulthorn compressor is supplied with a motor protector, sometimes referred

to as an overload. The more expensive the compressor, the greater is the

economic

justification for specifying a motor protector that has the ability to protect over a wider range of conditions.

1. External Motor Protectors

A smaller compressor (such as an AZ, AE or WJ) is fitted with an external motor protector. Most commonly, this is a compact, cylindrical device that contains a snapaction bimetallic disc. The protector is mounted in contact with the surface of the compressor housing, inside the terminal guard.

The compressor current passes through the bimetallic disc. The resistance of this disc causes the disc temperature to increase as the motor current increases. There is usually

a small heater, located under the disc and connected in series with the disc itself. This

heater further raises the temperature of the disc. There is also the impact of the compressor shell temperature, and a hot compressor will further increase the disc

temperature. The temperature of the disc is thus influenced by the combined effects of –

- the compressor motor current
- the compressor shell temperature

When the bimetallic disc reaches a predetermined temperature (often either 105°C or 120°C) the disc will snap open, and power supply to the compressor will be interrupted.

The compressor will cool, and at a reduced disc temperature the protector will reset

and the compressor will restart, or attempt to restart. If the abnormal condition that

caused the protector to trip in the first place still exists, the compressor is likely to continue to cycle on the overload until that condition is corrected.

There are two situations where a motor protector is expected to operate.

2. When the compressor is running under extreme conditions.

3. When the compressor is in a locked rotor condition. This is a situation where the

compressor cannot start because the voltage is too low, the system pressures are

outside the range for which the compressor is approved, there is internal damage to

the compressor, or there is some other reason why the compressor is incapable of

starting

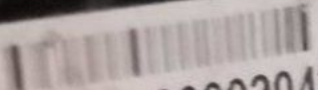

 **KULTHORN** 
 870611-00002043
C-QN76L6F-L
 80377116
 220-230V- 60Hz 1PH
 220V- 50Hz
 R134a
 RoHS

 28031
 MADE IN THAILAND
TEL. 870-2548

Model Number System

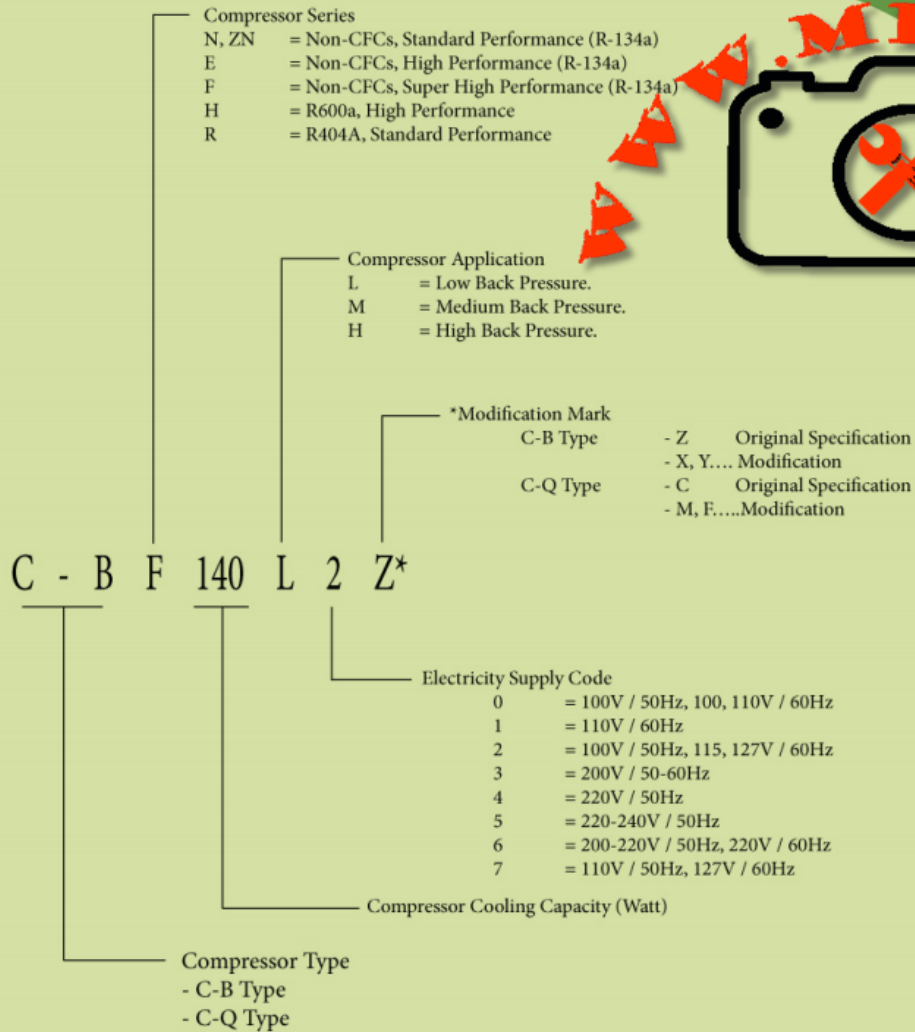

Private Picture Copyright : WWW.MBSM.PRO

[Mbsm_dot_pro_private_PDF_2019-06-13_110312_technical_bulletinTélécharger](#)

[Mbsm_dot_pro_private_PDF_kpccatalogTélécharger](#)

[Mbsm_dot_pro_private_PDF_KULTHORN-CATALOGUE_webTélécharger](#)

[Mbsm_dot_pro_private_PDF_Kulthorn-CatalogTélécharger](#)

[Mbsm_dot_pro_private_PDF_Model-Number-SystemTélécharger](#)



KULTHORN

COMPRESSOR

Private Picture Copyright : WWW.MBSM.PRO

Name: Kulthorn Premier Company Limited (KPC)
Established: December 1982
Registered Capital: Baht 1,125 Million
Address: 446/3 Moo 9 Chachoengsao – Nakornratchasima Road,
Kabinburi Industrial Estate, Nongki, Kabinburi, Prachinburi 25160, Thailand
Telephone: (037) 204835, 455516
Fax: (037) 455525, 204844
E-mail: sales_kpc@kulthorn.com
kamjorn@kulthorn.com
Employees: 900 persons
Land area: 91 rai (145,600 m²)
Building of area: 41,500 m²
Business Products: Hermetic Reciprocating Compressor (Scotch Yoke Mechanism)
(Product under license SANYO Japan) Size 30-250 Watt.

Compressor series / Refrigerant

C-BN, C-BZN, C-BE, C-BF / R-134a
C-QN / R-134a
C-BH / R-600a
C-BR / R-404A

Shareholder: Kulthorn Kirby Public Company Limited 100%
Customers: **Domestic** – Haier, Sanyo, Toshiba, Hitachi, Daewoo, Samsung, Sanden, etc.
Total = 35%
Export – Daewoo, Sanyo Group, GE, Sanden, Haier, Singer, Videocon,
Toshiba, etc.
Total = 65%

Quality System: ISO 9001:2000 Certified by TUV Nord Year 2003
Q-Mark Certified by F.T.I. Year 2007



Private Picture Copyright : WWW.MBSM.PRO

Mitsubishi, Refrigeration,
Compressor, for chiller,
JH527YEB, 10HP, 380 à 420 V 50 Hz,
460 V 60 Hz, 29,7 kW, 74 kg, R22

Category: compressor, Non classé
written by www.mbsm.pro | 11 January 2021

Model	Horsepower	Power	Refrigeration capacity			Voltage	Weight	Highth
	HP		KW	Frequenc y	KW			
JH512-Y	4HP	3.2	50Hz	13.1	11.3	N.T.Y.X. J	48.5	390.4
			60Hz	15.6	13.4			
JH513-Y	5HP	3.75	50Hz	14.3	12.3	N.T.Y.X. J	49	390.4
			60Hz	17	14.6			
JH515-Y	5.5HP	4.1	50Hz	16.3	14	N.T.Y.X. J	49	390.4
			60Hz	19.3	16.6			
JH516-Y	6HP	4.5	50Hz	17.1	15.2	T.Y	49	390.4
			60Hz	20.7	17.8			
JH517-Y	6.33HP	4.75	50Hz	18.7	16.1	T.Y.X.J	49	390.4
			60Hz	22	18.9			
JH518-Y	6.5HP	4.85	50Hz	19.9	17.1	T.Y.X	54.5	415.4
			60Hz	23.3	20			
JH519-Y	7.5HP	5	50Hz	21.3	18.3	T.Y.X.J	54.5	415.4
			60Hz	24.9	21.4			
JH521-Y	7.5HP	5.5	50Hz	23.3	20	T.Y.X.J	54.5	415.4
			60Hz	27.6	23.7			
JH522-Y	8HP	6	50Hz	25.1	21.6	T.Y.X	54.5	415.4
			60Hz	29.2	25.1			
JH525-Y	9.33HP	7	50Hz	27.3	23.5	T.Y.X.J	74.5	441.6
			60Hz	32	27.5			
JH527-Y	10HP	7.5	50Hz	29.7	25.5	T.Y.X.J	74.5	441.6
			60Hz	34.8	29.9			
JH529-Y	10.67HP	8	50Hz	31.9	27.4	T.Y.X	74.5	441.6

Private Picture Copyright : WWW.MBSM.PRO

Mitsubishi Refrigeration Compressor JH527YEB 10HP Données techniques

Model	Horsepower	Power	Refrigeration capacity			Voltage	Weight	Highth
	HP		KW	Frequenc y	KW			
JH512-Y	4HP	3.2	50Hz	13.1	11.3	N.T.Y.X. J	48.5	390.4
			60Hz	15.6	13.4			
JH513-Y	5HP	3.75	50Hz	14.3	12.3	N.T.Y.X. J	49	390.4
			60Hz	17	14.6			
JH515-Y	5.5HP	4.1	50Hz	16.3	14	N.T.Y.X. J	49	390.4
			60Hz	19.3	16.6			
JH516-Y	6HP	4.5	50Hz	17.1	15.2	T.Y	49	390.4
			60Hz	20.7	17.8			
JH517-Y	6.33HP	4.75	50Hz	18.7	16.1	T.Y.X.J	49	390.4
			60Hz	22	18.9			
JH518-Y	6.5HP	4.85	50Hz	19.9	17.1	T.Y.X	54.5	415.4
			60Hz	23.3	20			
JH519-Y	7.5HP	5	50Hz	21.3	18.3	T.Y.X.J	54.5	415.4
			60Hz	24.9	21.4			
JH521-Y	7.5HP	5.5	50Hz	23.3	20	T.Y.X.J	54.5	415.4
			60Hz	27.6	23.7			
JH522-Y	8HP	6	50Hz	25.1	21.6	T.Y.X	54.5	415.4
			60Hz	29.2	25.1			
JH525-Y	9.33HP	7	50Hz	27.3	23.5	T.Y.X.J	74.5	441.6
			60Hz	32	27.5			
JH527-Y	10HP	7.5	50Hz	29.7	25.5	T.Y.X.J	74.5	441.6
			60Hz	34.8	29.9			
JH529-Y	10.67HP	8	50Hz	31.9	27.4	T.Y.X	74.5	441.6



Private Picture Copyright : WWW.MBSM.PRO

Production Description

compresseur de réfrigération mitsubishi
modèle JH527YEB pour refroidisseur

Modèle	jh527yeb
Puissance en chevaux (Hp)	10,0
Réfrigérant	R22
An	2019
Couleur	Noir
Moq	1
type	Piston
Poids (kg)	74,5
Origine	JAPON
Emballage	Dessin animé / caisse en bois



REFRIGERANT COMPRESSOR

JH527YEB

MODEL

VOLT. 380~415 400~460 V	PHASE	3
REFRIGERANT R-22	FREQ.	50 / 60 Hz
AP 1.3 MPa	SP	3.9 MPa
DP 1.3 MPa	DT	-30 °C

DATE 2007 02

SERIAL 79722112

MITSUBISHI ELECTRIC CORPORATION
JAPAN





Private Picture Copyright: WWW.MBSM.PRO

Compresseurs, rotatifs, climatiseurs,
KG-INDUSTRIES, SG533F ,SG555F-A,
SG573F, SG533Q, SG553Q, SG513Q,
SG633G, SG633P, SG653P, SG673P,
SG733R, FGA550-A, FG313S-A, CG133B,
CG333D, CG433E, CG533F, CG533Q,
CG633G, CG633P

Category: compressor

written by www.mbsm.pro | 11 January 2021



Private Picture Copyright : WWW.MBSM.PRO

Caractéristiques

Appl.	Refrig.	Séries	Déplacement (ml / tr)	Ellipse	Tension (v)	Fréquence (Hz)	Capacité de refroidissement		Remarque		
							w	BTU / h			
T1	R22	SG	15,1	SG533F	220-240	50	2470	8430	CCEE / T ¹ V		
			15,1	SG555F-A	115	60	3090	10537	Sous application		
			15,1	SG573F	208-230	60	3065	10452	Sous application		
			16,2	SG533Q	220-240	50	2650	9037	CCEE / T ¹ V		
			16,2	SG553Q	110-120	60	3220	10980	UL		
			16,2	SG513Q	100	50	2813	9592			
						60	3402	11601			
			16,7	SG633G	220-240	50	2760	9412	CCEE / T ¹ V		
			17,3	SG633P	220-240	50	2850	9719	CCEE / T ¹ V		
			17,3	SG653P	110-120	60	3500	11935	UL		
			17,3	SG673P	208-230	60	3495	11918	UL		
			18,4	SG733R	220-240	50	2990	10196	CCEE / T ¹ V		
			R407C	CG	8,0	FGA550-A	115	60	1605	5473	Sous application
					13,3	FG313S-A	100	50	2330	7945	En développement
						60	2826	9637			
	10,4	CG133B			220-240	50	1710	5831	CCEE / T ¹ V		
	12,5	CG333D			220-240	50	(2060)	(7025)	En développement		
	14,1	CG433E			220-240	50	(2320)	(7911)	En développement		
	15,1	CG533F	220-240	50	(2470)	(8423)	En développement				
	16,2	CG533Q	220-240	50	2650	9037	CCEE / T ¹ V				
16,7	CG633G	220-240	50	(2760)	(9412)	En développement					
17,3	CG633P	220-240	50	(2850)	(9719)	En développement					

Dimensions des compresseurs

Séries	Ellipse	A (millimètre)	B (millimètre)	C (millimètre)	D (millimètre)	E (mm) (ID)	F (mm) (ID)	G (millimètre)	Dessin n °
SG	SG533F SG573F SG5330 SG5130 SG5530	242,0	193,0	65,0	99,0	8,2	9,8	54,5	N ° 1
	SG633F SG633P SG653P SG673P SG733R SG555F-A	256,0	193,0	65,0	99,0	8,2	9,8	55,5	N ° 1
	FGA550-A FG313S-A	221,8	193,0	65,0	99,0	8,2	9,8	45,7	N ° 1
CG	CG133B, CG5330	242,0	193,0	65,0	99,0	8,2	9,8	54,5	N ° 1
	SH733H SH733Q SH833JSH833K	256,4	252,0	70,0	114,0	9,7	12,9	60,3	N ° 2
SH	SH833K-G SH833U	278,4	262,5	80,0	120,5	9,7	12,9	60,3	N ° 2
	SH773H SH773Q SHZ33L SHZ73L	278,4	252,5	70,0	114,0	9,7	12,9	60,3	N ° 2
	SH933R SH973R	278,4	262,5	80,0	120,5	9,7	12,9	60,3	N ° 2
	SH933R-S	293,4	220,5	70,0	114,0	9,7	12,9	60,3	N ° 2
	SHZ83L-E SHY33M-G SHYH-D SHY33M-E SHY73M SHX33S SHW33T SHW73T	293,4	262,5	80,0	120,5	9,7	12,9	60,3	N ° 2
CH	SHV33Y-G SHV33Y	338,9	299,0	89,1	125,0	9,7	16,2	80,4	N ° 2
	CH933R-S CHY33M-S CHW33T	307,8	262,5	80,0	120,5	9,7	12,9	60,3	N ° 2
TH	THU33W	372,7	342,8	89,1	125,0	9,7	16,2	70,0	N ° 3

Dimensions des compresseurs contrôlés par onduleur									
Séries	Ellipse	A (millimètre)	B (millimètre)	C (millimètre)	D (millimètre)	E (mm) (ID)	F (mm) (ID)	G (millimètre)	Dessin n °
SG	SGZ280-Y SGZ28E-Y	256,0	228,0	70,0	102,5	8,2	12,9	68,0	N ° 1
	SG9280-N SGZ280-N SGZ28E-N	256,0	228,0	70,0	102,5	8,2	12,9	68,0	N ° 1
FG	FGZ28C-Y	242,0	193,0	65,0	99,0	8,2	9,8	54,5	N ° 1
SH	SHU28K-Y	293,4	268,0	89,1	125,0	9,7	16,2	60,3	N ° 2
TH	THS28M-Y	307,8	325,3	89,1	125,0	9,7	16,2	52,4	N ° 3



Private Picture Copyright : WWW.MBSM.PRO

Compressor, ZMC, EGM99AZ, 1/4 Hp, 1PH, R134a, LBP, 220-240V 50Hz

Category: compressor

written by www.mbsm.pro | 11 January 2021





Private Picture Copyright: WWW.MBSM.PRO

General Data

R134a	:Refrigerant
LBP	:Application
30°C to -10°C-	:Evaporating Temperature Range
220/240V/50 HZ	:Voltage/Frequency
Static	:Compressor Cooling
Capillary Tube	:Expansion Device
Multi - 96:120 pcs	:Packaging Quantity
CE-VDE-GOST	:Approvals



Private Picture Copyright: WWW.MBSM.PRO

Mechanical Data

cm ³ 350	:Oil Charge
ester	:Oil Type Configuration
cSt 19	:Oil Type Viscosity
kg 10.25	:Weight

Electrical Data

*RSIR / RSCR	:Motor Type
187-264V	:Voltage working range at 50 Hz
130°C	:Maximum Motor Temperature
A 10.19 / 14.49	:Locked Rotor Current
25.08Ω at 25°C	:Start Winding Resistance
Ω at 25°C 7.33	:Run Winding Resistance
ph 1	:Phase



Private Picture Copyright : WWW.MBSM.PRO

External Characteristics

(mm)	Internal Diameter
6.5	Suction Connector
4.9	Discharge Connector
6.5	Process Connector
Copper	Material

Electrical Components

PTC 14Ω	:Starting Device
T0137/xx	:Motor Protection



Private Picture Copyright : WWW.MBSM.PRO

Circuit Diagram for Mod 90 Terminal Board

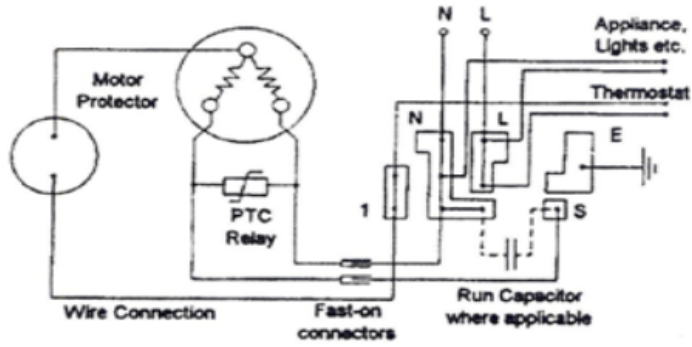

Circuit Diagram for U.H. Terminal Board

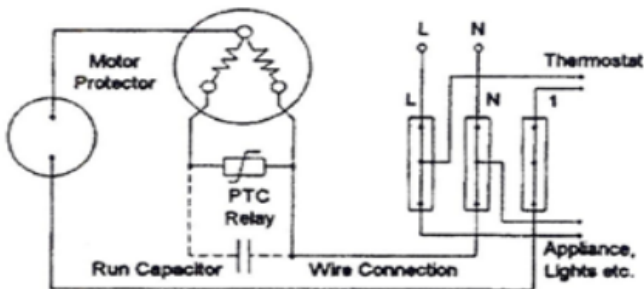

Private Picture Copyright : WWW.MBSM.PRO

PERFORMANCE CURVE DATA:

EGM99AZ

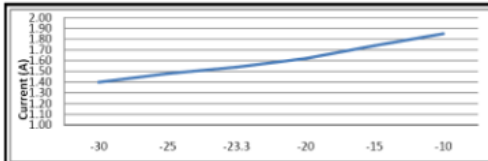
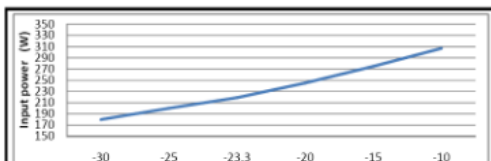
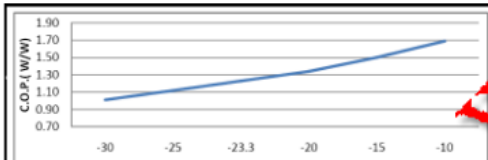
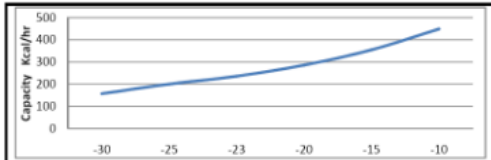

Test Condition: Ashrae, Static, Return Gas 32°C Subcooling OK, Evaporating: 23.3°C, Condensing: 55°C, Ambient: 32°C

Private Picture Copyright : WWW.MBSM.PRO



ZMC
R 134 a
EGM99AZ

EMX66CTC, Embraco, compresseurs, 183w, 240v / 50 1/4 HP, R600A, hermétiques, HVAC, + Ptc, Alu, Hotpoint, Indesit, Whirlpool, LBP, Cylindrique (cm3)10,61

Category: compressor

written by www.mbsm.pro | 11 January 2021



Private Picture Copyright: WWW.MBSM.PRO

catégorie de produit

Compresseurs de réfrigération et compresseurs de climatisation

Capacité

0,14 kW (0,1840 ch)

Évaluation du réfrigérant

R-600a

EER

1,18

Source d'énergie

230/50/1

Options de réfrigérant

R-600a

Ce produit est compatible avec les modèles suivants : RSZ 3032 V L BSZ 3032 V BAAAAAN 10 SBL 2031 V/HA UPS 1721 F/HA UFAAN 400 NF UPS 1721 F J/HA UPS 1721 F

J/HA UPS 1722 F J/HA CAA 55 BAAAN 12 SBL 2030 V/HA IUPS 1722 F J IUPS 1722 F J IUPS 1721 F J EXFL 2010 P FFFL 2010 K EXFL 2010 G SBL 203A V CAA 55 NX BIAAA 12 NCAA 55 NCAA 55 NX BIAAA 10 X BIAAA 10 UIAA 12 F UIAA 22 Y UIAA 12 F R (UK) UIAA 10 F EBYH 20320 V EBL 20311 V EBL 20321 V EBLH 18311 V 03 EBYH 18321 V NCAA 55 (UK) CAA 55 (UK) CAA 55 K (UK) CAA 55 S (UK) UPSY 1721 F J UPSY 1722 F J FZFM 151 G FZFM 151 P FZFM 171 P FZFM 171 G HSZ3022VL HSZ3022VL BIAA 33 F SI Y BIAA 33 F X H Y RFAA52P RFAA52S RFAA52K EBYH 18242 F EBYH 18242 F EBYH 18201 F EBYH 18201 F UIA 12 (EX) UIA 12 S (EX) FFUL 2012 P FFUL 2012 X FFUL 2012 X BIAAA 12 X HM325NI IN C 325 AA UK STF200WP NCAA 55 S (UK) EBYH 18213 F 03 H 18223 F 03 EBYH 18223 F 03 STF200WG FUFL 2010 P EBLH 18301 V 03 FZFM 171 SB NBIAAA 10 NRFAA50S NRFAA50P EBMH 17321 NX NCAA 55 K UK CAA 55 NX UK FFFL 2013 P (03) FFFL 2013 P (03) FFFL 2013 X L 2013 X (03) EBY 18211 F BIAAA 12 UK IUPSY 1722 F J DBIAA 344 F UK UPS 1521.1 RZFM 151 P.1 RZFM 151 G.1 UPS 1521 (TK).1 FFUL 2012 G UIAA 10 (TK).1 UIAA 12 S.1 NUIAA 12.1 UIAA 12 S (UK).1 UIAA 10 S.1 UIAA 12.1 UIAA 12.1 UIAA 10. 12 (UK).1 UIAA 10 (UK).1 UIAA 10.1 BCZ L 400 X (BI)/HA HTF200WP HTF200WG UPS 1746.1 T IN C 425 AA UK FFFL 2012 P FFFL 2012 G AFAA 52 P AI AFAA 52 K AI AFAA 52 S AI CAA 55 S NCAA 55 K EBYH 18242 D F YH 18242 D F ECORM 172 P ECOFL 2010 G ECOFL 2010 G ECOFL 2010 P ECOFL 2010 P BIAAA 12P X NBIAAA 10P BIAAA 12P BIAAA 10P X BIAAA 12P UK BIAAA 10P HM325NI AI UPS 1521 F (TK) NEBYH 18242 F UIAA 12 F I X UX UIX UIX IAA 12 F I UPSI 1721 F/HA UPSI 1721 F (TK)/HA UPSI 1722 F J/HA UPSI 1722 J FSFL 2010 P FZFI 171 G FZFI 171 P UPSO 1722 F J UPSO 1721 F J IUPS0 1721 F J et plus.



COOLING CAPACITY CECDMAF																		
CONDENSING TEMPERATURE °C	EVAPORATING TEMPERATURE °C						WEIGHT kg	MAX HEIGHT A mm	LRA A	COOLING TYPE	FAN AIR FLOW m³/h	OIL		EXP DEVICE	DRAWINGS		MODEL	
	-30	-25	-20	-15	-10	-5						CHARGE cm³	TYPE		EXTERNAL VIEW REFERENCE	WIRING DIAGRAM REFERENCE		
55	36	49	64	82	102	126	7,1	166	2,1	S	-	150	AB 5	C	DWG01	SM01	EMX20CLC	
45	44	58	76	96	119	146												
55	43	59	80	104	133	165	7,1	166	-	S	-	150	AB 5	C	DWG01	SM01	EMX26CLC	
45	53	72	96	124	156	192												
55	49	69	92	119	151	189	7,3	166	3,3	S	-	150	AB 5	C	DWG01	SM01	EMX32CLC	
45	64	86	111	141	176	218												
55	-	-	-	-	-	-	7,7	171	6,8	S/F	270	150	AB 5	C/V	DWG01	SM00-SM01	EMX3109Y	
45	-	-	-	-	-	-												
55	78	107	142	187	233	260	7,7	171	3,4	S	-	150	AB 5	C	DWG01	SM02	EMC40CLT	
45	88	118	154	198	248	300												
55	88	119	158	203	256	280	7,1	166	-	S	-	150	AB 2	C	DWG01	SM02	EMC46CLT	
45	95	129	169	215	269	310												
55	-	-	-	-	-	-	8	171	11,6	S/F	270	150	AB 5	C/V	DWG01	SM01	EMX3113Y	
45	-	-	-	-	-	-												
55	87	117	154	197	245	303	7,6	166	-	S	-	150	AB 5	C	DWG01	SM01	EMX55CLC	
45	102	135	175	222	277	339												
55	-	-	-	-	-	-	7,7	166	14,1	S/F	270	150	AB 5	C/V	DWG01	SM01	EMX3115Y	
45	-	-	-	-	-	-												
55	101	137	178	227	284	348	7,4	166	6,4	S	-	150	AB 5	C	DWG01	SM01	EMX66CLC	
45	122	160	207	261	323	394												
55	103	143	184	233	290	360	7,4	166	6	S	-	150	AB 5	C	DWG01	SM01	EMX70CLC	
45	123	164	210	263	327	403												
55	-	-	-	-	-	-	7,7	166	14,1	S/F	270	150	AB 5	C/V	DWG01	SM01	EMX3118Y	
45	-	-	-	-	-	-												
55	-	-	-	-	-	-	7,7	171	7,8	S/F	270	150	AB 5	C/V	DWG01	SM00	EMY3118Y	

Private Picture Copyright : WWW.MBSM.PRO

MODEL	DISPL. cm³	HP	VOLTAGE/FREQUENCY	MOTOR TYPE	TORQUE	APPLICATION	RATED POINT - ASHRAE -23,3 °C / 54,4 °C		RATED POINT - CECDMAF -25 °C / 55 °C		CONDENSING TEMPERATURE °C	EVAPORATING		
							CAPACITY W	EFFICIENCY W/W	CAPACITY W	EFFICIENCY W/W		-30	-25	-20
EMX20CLC	4,0	1/14	220-240V 50Hz 1 -	RSCR	LST	LBP	63	1,66	48	1,3	55	36	49	64
											45	44	58	76
EMX26CLC	5,2	1/12	220-240V 50Hz 1 -	RSCR	LST	LBP	81	1,68	60	1,32	55	43	59	80
											45	53	72	96
EMX32CLC	6,0	1/10	220-240V 50Hz 1 -	RSCR	LST	LBP	92	1,72	69	1,35	55	49	69	90
											45	64	86	111
EMX3109Y	6,2	1/10	100V 50Hz / 100-127V 60Hz 1 -	RSIR/RSCR	LST	L/MBP	100	1,68	-	-	55	-	-	-
											45	-	-	-
EMC40CLT	7,2	1/8	220-240V 50Hz 1 -	RSCR	LST	LBP	117	1,79	87	1,4	55	78	107	142
											45	88	118	154
EMC46CLT	8,0	1/7	220-240V 50Hz 1 -	RSCR	LST	LBP	133	1,8	98	1,37	55	88	119	158
											45	95	129	169
EMX3113Y	9,0	1/7	100V 50Hz / 100-127V 60Hz 1 -	RSCR	LST	L/MBP	155	1,75	-	-	55	-	-	-
											45	-	-	-
EMX55CLC	9,0	1/6	220-240V 50Hz 1 -	RSCR	LST	LBP	156	1,74	117	1,37	55	87	117	154
											45	102	135	175
EMX3115Y	10,6	1/5	100V 50Hz / 100-127V 60Hz 1 -	RSCR	LST	L/MBP	184	1,67	-	-	55	-	-	-
											45	-	-	-
EMX66CLC	10,6	1/5	220-240V 50Hz 1 -	RSCR	LST	LBP	183	1,73	137	1,37	55	101	137	178
											45	122	160	207
EMX70CLC	11,1	1/5	220-240V 50Hz 1 -	RSCR	LST	LBP	191	1,71	143	1,34	55	103	143	184
											45	123	164	210
EMX3118Y	12,2	1/5	100V 50Hz / 100-127V 60Hz 1 -	RSCR	LST	L/MBP	212	1,66	-	-	55	-	-	-
											45	-	-	-
EMY3118Y	12,2	1/5	220-240V 50Hz 1 -	RSIR	LST	L/MBP	212	1,49	157	1,16	55	-	-	-
											45	-	-	-
EMY3118Y	12,2	1/5	220-240V 50Hz 1 -	RSCR	LST	L/MBP	213	1,58	158	1,23	55	-	-	-
											45	-	-	-
EMX3118Y	12,2	1/5	220-240V 50Hz 1 -	RSCR	LST	L/MBP	214	1,72	159	1,34	55	-	-	-
											45	-	-	-

Private Picture Copyright : WWW.MBSM.PRO

Mbsm_dot_pro_private_PDF_emx66clc-1-embraco-compressors-10-2019Télécharger
Mbsm_dot_pro_private_PDF_emx66clc-2-embraco-compressors-10-2019Télécharger

COMPRESSEURS, 1/6, RSIR/RSCR, 124W,

CUBIGEL / ACC, TUBED, R600A, 1PH, HPKD190A, COMPRESSOR – HPKD190A, R600A, Compresseur Zel

Category: compressor

written by www.mbsm.pro | 11 January 2021



R600a

型号	电机	转速范围	排气量	电机类型	制冷量	输入功率	性能系数	高度	重量	认证
Model	Motor	Speed Range	Displ.	Motor Type	Cooling Capacity	Input Power	COP	Height	Net Weight	Certification
		rpm	cm ³		W	W	W/W	mm	kg	
220-240V/50Hz										
T系列变频 T Series VSC										
HKD66FSK	Al	1400-4000	6.6	PMSM	45-150	26-85	Up to 1.90	163	7.1	
HKD75FSK	Al	1400-4000	7.5	PMSM	52-170	29-96	Up to 1.90	163	7.1	
HKD86FSK	Al	1400-4000	8.6	PMSM	60-190	35-105	Up to 1.90	163	7.1	
HKD93FSK	Al	1400-4000	9.3	PMSM	70-210	40-125	Up to 1.90	163	7.1	
HKD10FSK	Al	1400-4000	10.5	PMSM	83-235	49-132	Up to 1.90	163	7.1	CCC
HKD12FSK	Al	1400-4000	11.5	PMSM	95-270	51-154	Up to 1.90	163	7.1	CCC
HKD66FSK I	Cu	1400-4000	6.6	PMSM	45-150	25-82	Up to 1.95	163	8.0	
HKD75FSK I	Cu	1400-4000	7.5	PMSM	52-170	28-93	Up to 1.95	163	8.0	
HKD86FSK I	Cu	1400-4000	8.6	PMSM	60-190	32-102	Up to 1.95	163	8.0	
HKD93FSK I	Cu	1400-4000	9.3	PMSM	70-210	38-115	Up to 1.95	163	8.0	
HKD10FSK I	Cu	1400-4000	10.5	PMSM	83-235	44-123	Up to 1.95	163	8.0	CCC
HKD12FSK I	Cu	1400-4000	11.5	PMSM	95-270	50-146	Up to 1.95	163	8.0	CCC
Z系列变频 Z Series VSC										
HXZ150FSM	Al	1200-4200	6.5	PMSM	42-150	23-80	Up to 1.90	145	6.9	-
HXZ170FSM	Al	1200-4200	7.0	PMSM	50-170	26-92	Up to 1.90	145	6.9	-
HXZ200FSM	Al	1200-4200	8.6	PMSM	56-200	30-103	Up to 1.90	145	6.9	-
HXZ220FSM	Al	1200-4200	9.2	PMSM	68-220	36-120	Up to 1.90	145	6.9	-
HXZ240FSM	Al	1200-4200	9.5	PMSM	75-240	39-125	Up to 1.90	145	6.9	-
HDZ150FSM	Al	1200-4200	6.5	PMSM	42-150	25-88	Up to 1.80	145	6.3	-
HDZ170FSM	Al	1200-4200	7.0	PMSM	50-170	27-98	Up to 1.80	145	6.3	-
HDZ200FSM	Al	1200-4200	8.6	PMSM	56-200	30-110	Up to 1.80	145	6.3	-
HDZ220FSM	Al	1200-4200	9.2	PMSM	68-220	40-132	Up to 1.80	145	6.3	-
HDZ240FSM	Al	1200-4200	9.5	PMSM	75-240	43-136	Up to 1.80	145	6.3	-

Private Picture Copyright : WWW.MBSM.PRO

HPKD190A

Congélateur, glacière, 180 à 280 litres, Compresseur LG MA57, 130 W, 1/6Hp, LBP, R134, 220-240V

Category: compressor, Non classé

written by www.mbsm.pro | 11 January 2021



Private Picture Copyright : WWW.MBSM.PRO

Application Réfrigérateur FF	MA57LBJG, MA57LHJG
Capacité	280 litres
Application Congélateur profond	MA57LBJG, MA57LHJG
Capacité	250 litres
Déplacement	5,7
Capacité de refroidissement	138 (kcal / h), 160 W, 548 (Btu / h), 0,215 HP
La puissance d'entrée	130 W
COP W / W	1.2
EER Btu / Wh	4,21
Type de moteur	RSIR-PTC
Dispositif de démarrage (PTC)	QP2-33MC1
Protecteur de moteur (OLP)	4TM232TFB
(Condensateur) Runnig / surtension	4uF / 400
(HUILE) Viscosité cst / Qté (cc)	22/220
Type de refroidissement	ST
Hauteur du compresseur	177 mm
Poids net	9,1 kg.

- Type de compresseur: LBP
- Consommation électrique: 130 W
- Capacité du réfrigérateur: 280 litres.
- Capacité du congélateur: 250 litres.
- Alimentation / fréquence: 220V / 50Hz

Le compresseur de réfrigérateur LG est un mini compresseur d'air courant, qui offre une solution de refroidissement complète pour les réfrigérateurs et les armoires de rangement à usage domestique et professionnel. Les compresseurs d'air LG pour réfrigérateur offrent un fonctionnement compact et silencieux, avec le couple le plus élevé (HST). Ce compresseur d'air garantit une qualité 6s et une fiabilité éprouvée dans le monde entier.

R134a

Modèle	Application	Tension V	Fréquence hz	PIÈCES ÉLECTRIQUES			PÉTROLE		Type de refroidissement		
				Type de moteur	Appareil de démarrage	Condensateur ProtecteurDépart	Viscosité (cst)	Qté			
NS30LBJG				RSIR	P470MC	4TM213SFB	22	180	ST		
NS36LBJG				RSIR	P470MC	4TM213SFB	22	180	ST		
MA53LAJG		220	50	RSIR	P330MC	4TM222VFB	dix	220	ST		
MA57LAJG				RSIR	P470MC	4TM213SFB	dix	220	ST		
NS24LADG				RSIR	P220MC	4TM101RFB	22	180	ST		
NS36LADG				RSIR	P220MC	4TM174TFB	22	180	ST		
NS36LADG		220	60	RSCR	P220MD	4TM174TFB	4/400	22	180	ST	
MA53LADG				RSIR	P330MC	4TM232NFB	dix	220	ST		
MA53LADM				RSCR	P330MD	4TM232NFB	5/400	dix	220	ST	
MA57LADM				RSCR	P330MD	4TM213SFB	5/400	dix	220	ST	
NS24LABG				RSIR	P330MC	4TM149NFB	22	180	ST		
NS30LABG				RSIR	P220MC	4TM158RFB	22	180	ST		
NS36LABG		220	50-60	RSIR	P220MC	4TM174TFB	22	180	ST		
MA53LABM				RSCR	P330MD	4TM232NFB	dix	220	ST		
MA57LABM				RSCR	P330MD	4TM213SFB	5/400	dix	220	ST	
NS24LAEG				RSIR	P220MC	4TM117SFB	22	180	ST		
NS24LBEG				RSIR	P330MC	4TM117SFB	22	180	ST		
NS30LAEG				RSIR	P330MC	4TM149NFB	22	180	ST		
MSA30LAEG				RSIR	P330MC	4TM149NFB	22	180	ST		
NS36LAEG				RSIR	P220MC	4TM149NFB	22	180	ST		
MSA43LBEGLBP				RSIR	P330MC	4TM166RFB	22	180	ST		
MSA43LAEM				RSCR	P330MD	4TM205RFB	4/400	22	180	ST	
MA53LAEC				RSIR	P330MC	4TM158RFB	dix	220	ST		
MA53LAEM				RSCR	P330MD	4TM232TFB	5/400	dix	220	ST	
MSB53LAJG				RSIR	P330MC	4TM213SFB	dix	180	ST		
MA57LAEG				RSIR	P330MC	4TM158RFB	dix	220	ST		
MA57LAEM				RSCR	P330MD	4TM205RFB	5/400	dix	220	ST	
MA57LBEG				RSIR	P330MC	4TM149NFB	dix	200	ST		
MC57LAEM		220-240	50	RSCR	P330MD	4TM166RFB	4/400	sept	200	ST	
MSB57LAEG				RSIR	P330MC	4TM166RFB	dix	180	ST		
MSB57LAEM				RSCR	P330MD	4TM166RFB	4/400	dix	180	ST	
MA62LCEG				RSIR	P330MC	4TM232VFB	dix	220	ST		
MA62LCEM				RSCR	P330MD	4TM205RFB	5/400	dix	220	ST	
MA62LDEG				RSIR	P330MC	4TM232VFB	dix	220	ST		
MA69LDEG				RSIR	P330MC	4TM232VFB	dix	220	ST		
MA69LCEG				RSIR	P330MC	4TM232VFB	dix	220	ST		
MA69LCEM				RSCR	P330MD	4TM232NFB	4/400	dix	220	ST	
MA98LAEM				RSCR	P470MD	4TM265RFB	4/400	dix	220	ST	
MC98LAEM				RSCR	P470MD	4TM265RFB	5/400	dix	220	ST	
MQ98LAEM				RSCR	P470MB	4TM265RFB	5/400	dix	220	ST	
MA108LAEH				RSE	P470MB	4TM276VFB	30/300	5/400	dix	220	ST



Private Picture Copyright : WWW.MBSM.PRO

Mbsm_dot_pro_private_PDF_LG_Refrigerator_Compressor_CatalogueTélécharger