

COMPRESSOR, DANFOSS, NL8.4MF, R134A, 1/4HP, 8.35CM³, Compressor Danfoss Secop NL8.4MF, 105G6879, MBP -R134a, 220-240V/1/50Hz, discharge 8.35 cm³, motor type RSIR / CSIR, oil type POE, oil charge 320 cm³, 741 W at +7.2 / +55° C, LRA 11.7 A, maximum refrigerant charge 600 g, height: 197 mm, weight 10.5 kg

Category: compressor

written by www.mbsm.pro | 13 December 2021



Private Picture Copyright: WWW.MBSM.PRO

230V 50/60HZ

FICHE TECHNIQUE COMPRESSEUR DANFOSS NL8.4MF AU R134A 1/4HP 8.35CM3

Puissance HP 1/4
Tension (V) 230
Fréquence (Hz) 50/60
Marque pie DANFOSS
Cylindré 8.35
Référence marque NL8.4MF



Private Picture Copyright : WWW.MBSM.PRO

Applications	HBP LBP MBP	
Charge en fluide frigorigène [kg] [Max]	1.3 kg	
Charge en huile [L]	600 L	
Code de configuration	Simple	
Couleur	Noir	
Courant d'appel HST [A]	18.6 A	
Description	SC18G	
Diamètre de raccordement à l'aspiration [mm]	10.2 mm	
Diamètre du raccord au refoulement [mm]	6.2 mm	
Diamètre du raccordement du traitement [mm]	6.2 mm	
Désignation du modèle	Compresseur	
Emballage (format)	Emballage industriel	
Faible valeur de plage de tension à 50 Hz [V]	187 V	
Faible valeur de plage de tension à 60 Hz [V]	198 V	
Faible valeur de tension nominale à 50 Hz [V]	208 V	
Faible valeur de tension nominale à 60 Hz [V]	220 V	
Fluides	R134a	
Fréquence [Hz]	50/60	
Hauteur de la base [mm]	213 mm	
Hauteur du raccordement de refoulement [mm]	110 mm	
Hauteur raccordement aspiration [mm]	193 mm	
Hauteur totale [mm]	219 mm	
LRA HST [A]	18.6 A	
Matériel du raccord au process	Acier cuivré	
Matériel du raccord d'aspiration	Acier cuivré	
Matériel du raccord de refoulement	Acier cuivré	
Niveau d'énergie de l'application	Compresseur universel	
Nombre de phases (compresseur)	1	
Nombre de phases (ventilateur)	1	
Norme d'approbation	CE EN 60335-2-34 avec Annexe AA	
Notes concernant le raccord de refoulement	Capuchon en aluminium	
Notes concernant le raccordement au process	Capuchon en aluminium	
Notes concernant le raccordement à l'aspiration	Capuchon en aluminium	
N° de modèle	SC18G	
N° de schéma	8258	
Oil type		POE
Phase		1
Puissance frigorifique nominale 60 kBTU/h		6.06 kBTU/h
Puissance frigorifique nominale à 60 Hz		1.8 kW
Quantité d'huile [cm³]		600 cm ³
Quantité par emballage		80
raccord de refoulement équerre [°]		37 °

raccord d'aspiration équerre [°]	37 °
Raccordement de process équerre	37 °
Régulation de la puissance	Vitesse fixe
Résistance de l'enroulement auxiliaire (enroulement de démarrage) pour compresseurs monophasés [ohm]	14.1 Ohm
Résistance de l'enroulement principal pour compresseurs monophasés [Ohm]	3.7 Ohm
Technique de la marque	Compresseur à pistons
Technologie	Piston
Température d'enroulement max. continue [°C] [Max]	125 °C
Température de l'enroulement à court terme [°C] [Max]	135 °C
Tension 50 Hz [V]	220 V
Tension 50 Hz [V] [max.]	240 V
Tension 60 Hz [V]	220 V
Tension 60 Hz [V] [max.]	240 V
Type	SC
Type de moteur	CSIR
Type de socle	Universel
Utilisation de tronçon	Réfrigération LT Réfrigération MT
Valeur du condensateur A	10 µF
Valeur du condensateur B	80 uF
Valeur élevée de plage de tension à 50 Hz [V]	254 V
Valeur élevée de plage de tension à 60 Hz [V]	254 V
Valeur élevée de tension nominale à 50 Hz [V]	230 V
Valeur élevée de tension nominale à 60 Hz [V]	230 V
Vitesse de rotation à 50 Hz [rpm]	2900 rpm
Vitesse de rotation à 60 Hz [rpm]	3500 rpm
Volume balayé [cm ³]	17.69 cm ³
Volume de gaz libre [cm ³]	1460 cm ³
Économiseur	No

Documents

Type de document	Country	Langue	Titre
	France	Français	
	Afrique du Sud	Anglais	
	Allemagne	Français	
	Australie Autriche	Allemand	
	Belarus Belgique	Anglais	
	Brazil Bulgarie	Arabe	
	Canada Chili Chine (continentale)	Bulgare	
	Colombie Corée du Sud	Chinois	
	Croatie	Coréen	
	Danemark	Croate	
	Emir.arab.unis	Danois	
	Espagne Estonia	Espagnol	
	Finlande Grande Bretagne	Estonien	
	Grèce	Finnois	Grec
	Hongrie Inde + Sikkim	Hindi	
	Indonésie	Hongrois	
	Ireland Islande	Hébreu	
	Israël Italie	Indonésien	
	Japon Kazakhstan	Islandais	
	Lettonie Lithuania	Italien	Titre
	Macedonia Malaisie	Japonais	
	Mexique N. Zélande	Kazakh	
	Norvège Pays-Bas	Letton	
	Philippines	Lituanien	
	Pologne Portugal	Norvégien	
	Roumanie Russian Federation	Néerlandais	
	Rép. tchèque Saudi Arabia	Polonais	
	Serbia	Portugais	
	Singapour	Roumain	
	Slovaquie Slovénie	Russe	Serbe
	Suisse Suède	Slovaque	
	Taiwan, Chine	Slovène	
	Thailand Tunisie	Suédois	
	Turquie Ukraine	Suédois	
	USA Viêt Nam	Tchèque	Thaï
	Vénézuéla	Turc	
		Ukrainien	
		Vietnamien	
Fiche technique	France	Français	220V Hermetic Compressors – R12 – R22 – R205 AI32443441788901-FR0101 1984 KB
Fiche technique	France	Français	Listing Compresseur Secop AI302136056984fr-FR0101 253 KB
Guide d'installation	France	Français	Instructions SC Compressors (external Protector) AN00008643706001-000401 124 KB
Guide d'installation	France	Français	Instructions SC Twin Compressors AN00008643707201-000101 183 KB

Type de document	Country	Langue	Titre
Fiche technique	France	Français	
Warranty	Afrique du Sud	Allemand	
Matériel promotionnel	Allemagne	Anglais	
Guide d'installation	Australie Autriche	Arabe	
EAC Declaration	Belarus Belgique	Bulgare	
Brochure	Brazil Bulgarie	Chinois	
Article UA	Canada Chili Chine (continentale)	Coréen	
Declaration	Colombie Corée du Sud	Croate	
Manuel d'utilisation	Danemark	Danois	
Electrical Safety Certificate	Emir.arab.unis	Espagnol	
	Espagne Estonia	Estonien	
	Finlande Grande Bretagne	Finnois Grec	
	Grèce	Hindi	
	Hongrie Inde + Sikkim	Hongrois Hébreu	
	Indonésie	Indonésien	
	Ireland Islande	Islandais	
	Israël Italie	Italien	
	Japon Kazakhstan	Japonais	
	Lettonie Lithuania	Kazakh	
	Macedonia Malaisie	Letton	
	Mexique N. Zélande	Lituanien	
	Norvège Pays-Bas	Norvégien	
	Philippines	Néerlandais	
	Pologne Portugal	Polonais	
	Roumanie Russian Federation	Portugais	
	Rép. tchèque Saudi Arabia	Roumain	
	Serbia	Russe Serbe	
	Singapour	Slovaque	
	Slovaquie Slovénie	Slovène	
	Suisse Suède	Suédois	
	Taiwan, Chine	Tchèque Thaï	
	Thailand Tunisie	Turc	
	Turquie Ukraine	Ukrainien	
	USA Viêt Nam	Vietnamien	
	Vénézuéla		

Matériel promotionnel

France

Français

Refrigerant Circuit

AV00008642183800-000402
463 KB

Compresseur Danfoss SC18G - R134a

Cylindrée = 17.69 CM3

APPLICATIONS = HP; BP; MP

Moteur = CSIR

220-240V 50/60Hz



Design

Displacement	cm ³	17.69
Oil quantity	cm ³	600 (550 on comp. with oil cooler)
Maximum refrigerant charge	g	1300
Free gas vol. in compressor	cm ³	1460
Weight without electrical equipment	kg	13.7

Motor

Motor size	watt	495
LRA (rated after 4 sec. UL984) HST	A	18.6
Cut-in current HST	A	18.6
Resistance, main and start winding (25°C)	Ω	3.7/14.1
Approvals		EN 60335-2-34, CCIB

Dimensions

104G8830 104G8820 104G8822

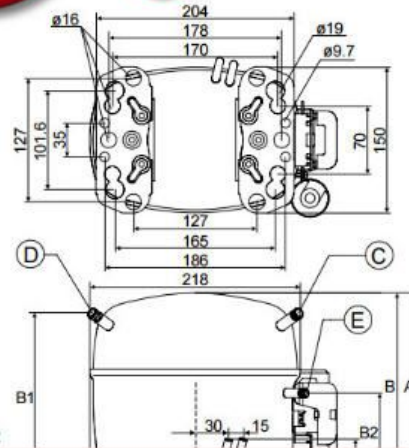

Private Picture Copyright : WWW.MBSM.PRO

R134a	refrigerant	605076	رقم القطعة
HP 1/2	power	SC18G	type
cm ³ 17.7	cylinder capacity	W 495	power input
V 220-240	voltage	CSIR	motor system
W 844	power at -10°C	mm 219	height
W 1343	power at 0°C	W 1074	power at -5°C
W -	power at -30°C	W 1655	power at +5°C
W 485	power at -20°C	W 348	power at -25°C
W 2014	power at +10°C	W 649	power at -15°C
HMBP	application	ASHRAE	test method
kg 13.7	weight	Hz 50	frequency



Private Picture Copyright : WWW.MBSM.PRO

Visuels

Mbsm_dot_pro_private_PDF_SC18GTélécharger



Private Picture Copyright : WWW.MBSM.PRO

Donper, Refrigeration, Compressr,
r134A, freezer, LU140CY1, CT6220CE,
AK120CY1, 1/3Hp-

Category: compressor

written by www.mbsm.pro | 13 December 2021



Private Picture Copyright : WWW.MBSM.PRO

Product Description

Donper Refrigeration Compressor R134A

- Famous and Popular Compressors
- D series hermetic compressors for R134A mainly are designed for applications in water dispenser, small freezer. The main characteristics of D series are light weight, compact size, high reliability, low noise and low vibration.
- R134A S series hermetic compressor mainly are designed for applications in water dispenser, small refrigerator, small freezer. The main characteristics of S series are light weight and compact size, reliability, low noise and high low vibration. By the optimal design of the suspension system and the continuous curvature design of its housing, low operating vibration and sound levels have been achieved.

R600a Series

Refrige- rant	Applica- tion	Model	Series	Power	Cooling	Motor Power type supply	Power capacity	Cooling W/W	COP
*ASHRAE -23.3	*CECOMAF	-25	*ASHRAE -23.3	*CECOMAF -25					
R600a	LBP	W40CY	IN	1/14	S	hatch 220/50	55	43	0.9 0.75
R600a	LBP	S53CY	S	1/10	S	hatch 220/50	75	57	1.2 0.95
R600a	LBP	S65CY	S	1/8	S	hatch 220/50	95	72	1.2 0.95
R600a	LBP	S75CY	S	1/7	S	hatch 220/50	118	86	1.2 0.95
R600a	LBP	SK53CY	S	1/10	S	RSCR 220/50	75	57	1.3 1.03

R600a	LBP	L76CY	L	1/6 S	hatch 220/50	132	100	1.36	1.07
R600a	LBP	L88CY	L	1/5 S	hatch 220/50	153	116	1.36	1.07
R600a	LBP	QD60AY	NOT	1/7 S	hatch 100/60	125	95	1.35	1.07
R600a	LBP	QD76Y	NOT	1/6 S	hatch 220/50	132	100	1.36	1.07
R600a	LBP	QD88Y	NOT	1/5 S	hatch 220/50	153	116	1.36	1.07
R600a	LBP	QD100Y	NOT	1/5 + S	hatch 220/50	170	129	1.38	1.09
R600a	LBP	QD123Y	NOT	1/4 S	hatch 220/50	187	142	1.38	1.09
R600a	LBP	LK88CY	L	1/5 + S	RSCR 220/50	160	122	1.58	1.25
R600a	LBP	QD100YG	NOT	1/4 + S	RSCR 220/50	180	137	1.58	1.25
R600a	LBP	QD135YG	NOT	1/4 + S	RSCR 220/50	215	163	1.58	1.23
R600a	LBP	QD153YG	NOT	1/4 + S	RSCR 220/50	246	184	1.58	1.23
R600a	LBP	LU68CY	L	1/7 S	RSCR 220/50	120	91	1.56	1.22
R600a	LBP	QD68YU	NOT	1/7 S	RSCR 220/50	120	91	1.56	1.22
R600a	LBP	QD76YU	NOT	1/6 S	RSCR 220/50	140	106	1.65	1.3
R600a	LBP	QD88YU	NOT	1/5 S	RSCR 220/50	160	122	1.68	1.33
R600a	LBP	QD100YU	NOT	1/4 S	RSCR 220/50	180	137	1.7	1.34
R600a	LBP	QD123YU	NOT	1/4 S	RSCR 220/50	196	150	1.68	1.3
R600a	LBP	QD135YU	NOT	1/4 + S	RSCR 220/50	220	168	1.68	1.3
R600a	LBP	QD153YU	NOT	1/4 + S	RSCR 220/50	248	189	1.65	1.28
R600a	LBP	QD68YZ	NOT	1/6 S	RSCR 220/50	120	91	1.8	1.42
R600a	LBP	QD76YZ	NOT	1/6 S	RSCR 220/50	140	106	1.8	1.42
R600a	LBP	QD88YZ	NOT	1/5 + S	RSCR 220/50	165	125	1.8	1.42
R600a	LBP	QD100YZ	NOT	1/4 + S	RSCR 220/50	185	141	1.8	1.42
R600a	LBP	QD135YZ	NOT	1 / 3- S	RSCR 220/50	220	168	1.8	1.42
R600a	LBP	QD60YT	NOT	1/8 S	ESCR 220/50	106	81	1.88	1.48
R600a	LBP	QD68YT	NOT	1/7 S	ESCR 220/50	126	96	1.9	1.5
R600a	LBP	QD76YT	NOT	1/6 S	ESCR 220/50	146	111	1.94	1.53
R600a	LBP	LU68PY	L	1/7 S	BLDC 220/50	120	91	1.65	1.3
R600a	LBP	LU68PY	L	1/5 S	BLDC 220/50	160	122	1.65	1.3

Model no	L140CY1	Refrigerant	R600a
Cooling capacity	230W	Input power	170W
Hose Power	1/3- HP	Temperature application	LBP
Displacement	14cm ³	Working Current	1.3A
Voltage	220V~240V/50Hz	COP	1.35W/W
Motor type	RSIR	Cylinder capacity	14cm ³
Cooling type	Need a fan motor	Weight	8.6±0.4kg



Private Picture Copyright : WWW.MBSM.PRO

Quick Details

Condition:	New	Applicable Industries:	Hotels, Restaurant, Home Use, Food Shop, Food & Beverage...
Showroom Location:	None	Video outgoing-inspection:	Not Available
Machinery Test Report:	Not Available	Marketing Type:	Ordinary Product
Brand Name:	Dongbei/OEM	Place of Origin:	Hubei, China
Application:	Refrigeration Parts	Type:	Refrigeration Compressor
Product name:	R600a 1/3 hp Refrigeration Commercial Freezer Compressor	Warranty:	1 year
Voltage:	220V~240V/50HZ	Refrigerant:	R600a
Cooling capacity:	230W	Horse Power:	1/3
Cylinder capacity:	14 Cubic Centimetre	Input power:	170W
Motor Type:	RSIR	Working current:	1.3A
After Warranty Service:	Online support	Weight:	8.6±0.4kg
Certification:	CCC/VDE	Local Service Location:	None
		After-sales Service Provided:	Online support



Private Picture Copyright : WWW.MBSM.PRO

COOLING CAPACITY	230W
REFRIGERANTS	R600a
INPUT POWER	170W
HORSE POWER	1/3-
DISPLACEMENT	14cm ³



Model no	L140CY1	Refrigerant	R600a
Cooling capacity	230W	Input power	170W
Hose Power	1/3- HP	Temperature application	LBP
Displacement	14cm ³	Working Current	1.3A
Voltage	220V~240V/50Hz	COP	1.35W/W
Motor type	RSIR	Cylinder capacity	14cm ³
Cooling type	Need a fan motor	Weight	8.6±0.4kg

Private Picture Copyright : WWW.MBSM.PRO

PDF

Réfrigerator, Freezer, GR-B562YLC, 420L, 20 Feet, Compressor, 1/3HP, R134A, 135G , LG GR-B562YLC, Bio Shield, Vitamin Plus, Carbon deodorizer

Category: compressor, Freezer, Technologie
 written by www.mbsm.pro | 13 December 2021



Private Picture Copyright : WWW.MBSM.PRO

BRAND TYPE Rp (000) FEATURES

ELECTROLUX ERM-1500 Rp.1588 154lt, Semi Auto Defrost, Low Voltage

LG GC-051SA 1220 46 lt Portable refrigerator

LG GN-V191RL Rp.1551 190lt, Semi Auto Defrost, vertical handle

LG GN-V191RLK Rp.- 190lt, Semi Auto Defrost, XL freezer, Door Lock

LG GN-V191SL Rp.1561 190lt, Semi Auto Defrost, horizontal handle

LG GN-V191SLT Rp.1531 190lt, Semi Auto Defrost, Direct Cooling, Magic Crisper

LG GN-V231RL Rp.1721 230lt, Semi Auto Defrost, vertical handle

LG GN-V231SL Rp.1671 230lt, Semi Auto Defrost, horizontal handle

PANASONIC NR-A172D-ST Rp.1539 155 Lt, Alowa +, Colour: Stainless

PANASONIC NR-A172M Rp.1429 155 Lt, Alowa +, Colour: Orange, Night Blue & Savanna Green

PANASONIC NR-A172S Rp.1399 155 Lt, Alowa +, Colour: Moccachino, Black coffee hairline

PANASONIC NR-A192D-ST Rp.1639 164 Lt, Alowa +, Colour: Stainless

PANASONIC NR-A192M Rp.1499 164 Lt, Alowa +, Colour: Orange, Night Blue & Savanna

Green

PANASONIC NR-A192S Rp.1499 164 Lt, Alowa +, Colour: Moccachino, Black coffee hairline

SAMSUNG RA-19PTMU Rp.- 190Lt, Direct cooling, Anti Bacterial Gasket

SAMSUNG RA-19PTPG Rp.- 190Lt, Direct cooling, Anti Bacterial Gasket

SAMSUNG RA-19PTTS Rp.- 190Lt, Door Alarm: 2 min, Anti bacterial gasket

SAMSUNG RA-21PTTS Rp.- 210Lt, Direct cooling, Anti Bacterial Gasket

SANYO SR-D167SB Rp.1290 Semi Auto Defrost, Direct Cooling System

SANYO SR-D182SB Rp.1430 160 lt, Semi auto defrost, 505x510x1160, colour: batik red

SANYO SR-D187SB Rp.1339 Semi Auto Defrost, Direct Cooling System

SANYO SR-D188SB Rp.1490 160 lt, Semi auto defrost, 505x510x1160

SANYO SR-D216SB Rp.1490 Semi auto defrost, 505 x 510 x 1310

SANYO SR-D50 Rp.- 50 lt, 22w, Super silent compressor

SANYO SR-D75 Rp.- 75 lt, 24w, Super silent compressor

SHARP SJ-S170T-RD Rp.1627 SAMURAI series, 160 lt, Anti Bacteria, Semi Auto Defrost

SHARP SJ-S190T-RD Rp.1697 SAMURAI series, 170 lt, Anti Bacteria, Semi Auto Defrost

SHARP SJ-S200T-RD Rp.1747 SAMURAI series, 170 lt, Anti Bacteria, Semi Auto Defrost

SHARP SJ-D17T-SL Rp.1919 Knight series, 150 Lt, Semi Auto Defrost

SHARP SJ-17MKII Rp.1437 170lt, Low voltage, Gripless Handle

SHARP SJ-19MKII Rp.1527 170lt, Low voltage, Gripless Handle

SHARP SJ-22SE Rp.- 180lt, Extra Big Freezer, Semi Auto Defrost

SHARP SJ-G191T Rp.1627 170 Lt, Lemon Series Refrigerator, Low voltage

SHARP SJ-G200T Rp.- Lemon Series Refrigerator, Honeycomb Deodorizer

SHARP SJ-G220T Rp.- Lemon Series Refrigerator, Low voltage

SHARP SJ-K170T Rp.- Lemon Series Refrigerator, Anti Bacteria, Key

SHARP SJ-K190T Rp.- Lemon Series Refrigerator, Anti Bacteria, Key

SHARP SJ-K230T Rp.- Lemon Series Refrigerator, Anti Bacteria, Key

TOSHIBA GR-N9P Rp.1282 70 lt, Portable, Ultra Direct Cooling, Glacio XD7

TOSHIBA GR-N155BC Rp.1281 120 lt, 22 w, Glacio XD7

TOSHIBA GR-N175BC Rp.1422 150 lt, 25 w, Glacio XD7

TOSHIBA GR-N178JZ-T Rp.1422 Glacio Jazz series, Silver ion anti bacteria, Colour:

Titanium

TOSHIBA GR-N178JZ-W Rp.1422 Glacio Jazz series, Silver ion anti bacteria, Colour:

White

TOSHIBA GR-N185BCH Rp.1422 160 lt, 27 w, Glacio XD7

TOSHIBA GR-N188JZ-T Rp.1521 Glacio Jazz series, Silver ion anti bacteria, Colour:

Titanium

TOSHIBA GR-N188JZ-W Rp.1521 Glacio Jazz series, Silver ion anti bacteria, Colour:

White

TOSHIBA GR-N195C Rp.1477 165 lt, 27 w, Glacio XD7

TOSHIBA GR-N198 Rp.- 165 Lt, Glacio XD7, Silver Ion Anti Bacteria, 27W

TOSHIBA GR-N228 Rp.- 180 Lt, Glacio XD7, Silver Ion Anti Bacteria, 30W

TOSHIBA GR-N198W Rp.- 165 Lt, Dispenser, Glacio XD7, Silver Ion Anti Bacteria, 27W
TOSHIBA GR-N228W Rp.- 180 Lt, Dispenser, Glacio XD7, Silver Ion Anti Bacteria, 30W
= FREEZER =
BRAND TYPE Rp (000) FEATURES
SANYO HF-S4LL Rp.1929 120 lt, 4 rak
SANYO HF-S6L Rp.2229 180 lt, 6 rak
TOSHIBA GF-K149 Rp.1881 4 rak, kunci
TOSHIBA GF-K169 Rp.2021 5 rak, kunci
TOSHIBA GF-K189 Rp.2181 6 rak, kunci
= KULKAS 2 PINTU / 2 DOORS REFRIGERATOR =
BRAND TYPE Rp (000) FEATURES
ELECTROLUX ETB-1800PC Rp.2848 180 Lt, Jet Air Cooling System, Deodorizer, Door alarm
ELECTROLUX ETB-2300PC Rp.3488 230 Lt, Multi Airflow System, Deo Fresh Active, Door alarm
ELECTROLUX ETB-2600PC Rp.4388 260 Lt, Multi Airflow System, Deo Fresh Active, Door alarm
ELECTROLUX ETB-3200PC Rp.4888 320 Lt, Multi Airflow System, Deo Fresh Active, Door alarm
ELECTROLUX ETE-4407SD Rp.8088 440 Lt, Jet Air Curtain System, UV Platinum deodorizer
ELECTROLUX ETM-4407PD Rp.7289 440 Lt, Jet Air Curtain System, Active Deo, Colour: Silver
ELECTROLUX ETM-4407SD Rp.7729 440 Lt, Jet Air Curtain System, Active Deo, Colour: Stainless
ELECTROLUX ETM-5107SD Rp.8689 520 Lt, Active Hybrid Deodorizer, Colour: Stainless
ELECTROLUX ETE-5107SD Rp.8999 522 Lt, UV Platinum Deo, LED display, Colour: Stainless
LG GN-V212RL Rp.2283 210 lt, Vit + Ion, Multi Airflow Cooling System
LG GN-V212RP Rp.2589 210 Lt, Health+ system, Vitamin+
LG GN-V212SL Rp.2179 210 lt, Multi Airflow Cooling System
LG GN-V212SLT Rp.2179 210 lt, Multi Airflow Cooling System
LG GN-V222RLT Rp.2489 220 lt, Vit + Ion, Multi Airflow Cooling System
LG GN-V222RP Rp.2839 220 Lt, Health+ system, Vitamin+
LG GN-V222SLT Rp.2289 220 lt, Vit + Ion, Multi Airflow Cooling System
LG GN-V262RLC Rp.2849 234 lt, Multi Airflow, Moist Balance Crisper
LG GN-V262RLCT Rp.2849 234 lt, Vitamin Plus, Moist Balance Crisper
LG GN-V282RLC Rp.2979 253 lt, , Multi Airflow, Moist Balance Crisper
LG GN-V282RLCT Rp.2989 253 lt, Vitamin Plus, Moist Balance Crisper
LG GN-B352CLC Rp.3849 291lt Nett capacity, Vitamin Plus, Ion Carbon Deodorizer
LG GN-M352CLN Rp.4349 288 lt Nett capacity, Bio Shield, Vitamin Plus, LED display

LG GN-B392CLC Rp.4139 321lt Nett capacity, Vitamin Plus, Ion Carbon Deodorizer
LG GN-M352CPC Rp.4241 288 lt Nett capacity, Door Cooling, Vit Plus, Green Ion
Deo,
Flora finishing
LG GN-M352CPC-APG Rp.4229 288 lt Nett capacity, Door Cooling, Vit Plus, Green
Ion Deo,
Flora finishing
LG GN-M392CPC Rp.4459 318 lt Nett capacity, Door Cooling, Vit Plus, Green Ion
Deo,
Flora finishing
LG GN-M392CPC-APG Rp.4459 288 lt Nett capacity, Door Cooling, Vit Plus, Green
Ion Deo,
Flora finishing
LG GN-B492CLC Rp.- 393 lt Nett capacity, Vitamin Plus, Ion Carbon Deodorizer
LG GN-B492GLC Rp.4689 490Lt, Fresh OZone, Bigger Fruits & Veggie Box
LG GN-M492CLN Rp.5369 388 lt Nett capacity, Bio Shield, Vitamin Plus, LED
display
LG GN-M492CPC Rp.- 388 lt Nett capacity, Door Cooling, Vit Plus, Green Ion Deo,
Flora finishing
LG GN-M492CPC-APG Rp.5239 388 lt Nett capacity, Door Cooling, Vit Plus, Green
Ion Deo,
Flora finishing
LG GN-M492GLH Rp.5551 490Lt, Anti-Bacterial Health Guard, Ext Temperature
Control
LG GN-M492GPC Rp.5459 490Lt, Green Ion Door Cooling, External Temperature
Control
LG GN-B562GLC Rp.5159 560Lt, Fresh OZone, Bigger Fruits & Veggie Box
LG GN-M562GLH Rp.6081 560Lt, Anti-Bacterial Health Guard, Ext Temperature
Control
LG GN-M562GPC Rp.5682 560Lt, Green Ion Door Cooling, External Temperature
Control
LG GN-B602GLC Rp.5749 600Lt, Fresh OZone, Bigger Fruits & Veggie Box
LG GN-M602GPC Rp.6172 600Lt, Green Ion Door Cooling, External Temperature
Control
LG GN-M602GLH Rp.6581 600Lt, Anti-Bacterial Health Guard, Ext Temperature
Control
LG GN-B702GPC Rp.7229 700Lt, Green Ion Door Cooling, External Temperature
Control
LG GN-M702GLH Rp.7881 700Lt, Anti-Bacterial Health Guard, Ext Temperature
Control
LG GN-M702GPH Rp.8121 700Lt, Anti-Bacterial Health Guard, Ext Temperature
Control
PANASONIC NR-B222M Rp.2399 210 Lt, Eco compressor (Energy saving up to 30%),
Colour: Coral Blue, Savanna Green, Sapphire Violet
PANASONIC NR-B222R Rp.2399 210 Lt, Eco compressor (Energy saving up to 30%),
Colour: Lily Starlight Silver, Lily Praline Brown
PANASONIC NR-B222S-H Rp.2399 210 Lt, Eco compressor (Energy saving up to 30%),
Colour: Iris Black Hairline
PANASONIC NR-B262M Rp.2582 223 Lt, Eco compressor (Energy saving up to 30%),
Colour: Coral Blue, Savanna Green, Sapphire Violet

PANASONIC NR-B262R Rp.2659 223 Lt, Eco compressor (Energy saving up to 30%),
Colour: Lily Starlight Silver, Lily Praline Brown

PANASONIC NR-B262S-H Rp.2659 223 Lt, Eco compressor (Energy saving up to 30%),
Colour: Iris Black Hairline

SAMSUNG RT-2A SRTS1 Rp.- 196LT, Humidity adjustable for optimal freshness and
nutrients

SAMSUNG RT-2B SLTS Rp.- 280 Lt, Silver Nano deodorizer, Coolever zone

SAMSUNG RT-2B SRIS Rp.- 280 Lt, Cool Pack, Silver Plus deo, Colour: inox silver

SAMSUNG RT-41TSGL Rp.5441 336 Lt, Cool Pack, Silver Plus deo, Colour: glass door

SAMSUNG RT-45USGL Rp.5781 450 Lt, Cool Pack, Silver Plus deo, Colour: glass door

SANYO SR-D225NSB Rp.2339 Nano Ferrite Filter, Carbon deodorizer

SANYO SR-D245NSB Rp.2649 Nano Ferrite Filter, Carbon deodorizer

SHARP SJ-F201C-HD Rp.2382 2337 BATIQUÉ Series, 173 Lt, Automatic Defrosting

SHARP SJ-F231C-HD Rp.2633 2547 BATIQUÉ Series, 180 Lt, Automatic Defrosting

SHARP SJ-F201S-RD Rp.2578 2387 SAMURAI series, 170 lt, Anti bacteria

SHARP SJ-F231S-RD Rp.2615 2582 SAMURAI series, 180 lt, Anti bacteria

SHARP SJ-F201G Rp.- Fresh Lemon Series Refrigerator, Low Voltage

SHARP SJ-F231G – Fresh Lemon Series Refrigerator, Low Voltage

SHARP SJ-F232G – 180 lt, Fresh Lemon Series, Low Voltage

SHARP SJ-F233G – 180 lt, Fresh Lemon Series, Low Voltage

SHARP SJ-F232K Rp.- 180 lt, Fresh Lemon Series, Low Voltage, Door key

SHARP SJ-F240G Rp.- 221 lt, Fresh Lemon Series, Low Voltage

SHARP SJ-D22LV-SL Rp.- 195 lt, Lemon Series Refrigerator, Low Voltage

SHARP SJ-D27LV-SL Rp.- 210 lt, Lemon Series Refrigerator, Low Voltage

SHARP SJ-D30LV-SL Rp.- 235 lt, Lemon Series Refrigerator, Low Voltage

SHARP SJ-291NLV-SL Rp.- 260 lt, Lemon Series Refrigerator, Low Voltage

SHARP SJ-351NLV-SL Rp.- 300 lt, Lemon Series Refrigerator, Low Voltage

SHARP SJ-F420G-SS Rp.3727 310 lt, King Samurai Series, No Frost, Deodorizer

SHARP SJ-F420G-PS Rp.3927 310 lt, King Samurai Series, No Frost, Deodorizer

SHARP SJ-431NLV-SL Rp.- 320 lt, Lemon Series Refrigerator, Low Voltage

SHARP SJ-P470NLV-SL Rp.5757 367 lt, Vetro Series, Plasmacluster Ion, Colour:
Silver

SHARP SJ-P470NLV-B Rp.5887 367 lt, Vetro Series, Plasmacluster Ion, Colour:
Black

SHARP SJ-P471NLV-GS Rp.6482 367 lt, Vetro Series, Plasmacluster Ion, Colour:
Glass Silver

SHARP SJ-P471NLV-GB Rp.6682 367 lt, Vetro Series, Plasmacluster Ion, Colour:
Glass Black

SHARP SJ-P570NLV-SL Rp.- 397 lt, Vetro Series, Plasmacluster Ion, Colour: Silver

SHARP SJ-P570NLV-B Rp.- 397 lt, Vetro Series, Plasmacluster Ion, Colour: Black

SHARP SJ-P571NLV-GS Rp.- 397 lt, Vetro Series, Plasmacluster Ion, Colour: Glass
Silver

SHARP SJ-P571NLV-GB Rp.- 397 lt, Vetro Series, Plasmacluster Ion, Colour: Glass
Black

SHARP SJ-461NLV Rp.- 367 lt, SALSA Series Refrigerator, Hybrid Cooling System

SHARP SJ-P461NLV Rp.- 443 lt, SALSA Series Refrigerator, Plasmacluster Ion
System

SHARP SJ-561NLV Rp.- 397 lt, SALSA Series Refrigerator, Hybrid Cooling System

SHARP SJ-P561NLV Rp.- 478 lt, SALSA Series Refrigerator, Plasmacluster Ion
System

SHARP SJ-P581NLV Rp.- 437 lt, SALSA Series Refrigerator, Hybrid Cooling System, Plasmacluster, Advance LEC Control, Nano Deodorizer
SHARP SJ-P651NLV Rp.- 473 lt, SALSA Series Refrigerator, Hybrid Cooling System, Plasmacluster, Advance LEC Control, Nano Deodorizer
SHARP SJ-P751NLV Rp.- 514 lt, SALSA Series Refrigerator, Hybrid Cooling System, Plasmacluster, Advance LEC Control, Nano Deodorizer
SHARP SJ-P851NLV Rp.- 555 lt, SALSA Series Refrigerator, Hybrid Cooling System, Plasmacluster, Advance LEC Control, Nano Deodorizer

SHARP SJ-WS400T Rp.9347 326 Lt, Dual Swing Door, Energy Saving with Inverter

TOSHIBA GR-M245E Rp.2141 180 lt, No Frost, Glacio XD7

TOSHIBA GR-M245D Rp.2391 180 lt, No Frost, Deodorizer, Glacio XD7

TOSHIBA GR-M265D Rp.2731 216 lt, No Frost, Deodorizer, Glacio XD7

TOSHIBA GR-M258 Rp.2291 216 lt Glacio Jazz, No Frost, Low Voltage

TOSHIBA GR-R21ET Rp.- Import, 180 lt, Health series, Platinum Deodorizer

TOSHIBA GR-R25ET Rp.3491 Import, 228 lt, Health series, Platinum Deodorizer

TOSHIBA GR-R35ED Rp.4551 Import, 280 lt, Hybrid Plasma Deo, AG+ Crisper

TOSHIBA GR-R42ED Rp.4921 Import, 320 lt, Hybrid Plasma Deo, AG+ Crisper

TOSHIBA GR-R48ED Rp.- Import, 401 lt, Hybrid Plasma Deo

TOSHIBA GR-R51ED Rp.5621 Import, 401 lt, Hybrid Plasma Deo, AG+ Crisper

TOSHIBA GR-R58ED Rp.7381 6661 Import/Complete Built-up, 500 lt, Hybrid Plasma Deo

TOSHIBA GR-R66ED Rp.8725 8261 Import/Complete Built-up, 590 lt, Hybrid Plasma Deo

TOSHIBA GR-RG43ED Rp.- Import, 355 lt, Hybrid Plasma Deo, Glass door

TOSHIBA GR-RG46ED Rp.5621 Import, 410 lt, Hybrid Plasma Deo, AG+ Crisper, Glass door

TOSHIBA GR-RG48ED Rp.- Import, 410 lt, Hybrid Plasma Deo, Glass door

TOSHIBA GR-RG51ED Rp.- Import, 500 lt, Hybrid Plasma Deo, AG+ Crisper, Glass door

TOSHIBA GR-RG58ED Rp.7851 Import, 500 lt, Hybrid Plasma Deo, Glass door

TOSHIBA GR-RG66ED Rp.8961 Import, 590 lt, Hybrid Plasma Deo, Glass door

= KULKAS 3 PINTU / 3 DOORS REFRIGERATOR =

BRAND TYPE Rp (000) FEATURES

ELECTROLUX ETB-2603PC Rp.4889 Deo Fresh Active, Multi Airflow System

TOSHIBA GR-R50EDV Rp.6129 Import/Complete Built-up, 3 doors

SIDE-BY-SIDE REFRIGERATOR

ELECTROLUX ESE-5608TA Rp.13828 555 lt, Crisper with Adjustable Humidity Control

LG GC-B207BLQ Rp.9222 581 lt, Icebeam Door Cooling System, LED Display

LG GC-B207CLC Rp.8151 581 lt, Bio Shield, Moist Balance™ Crisper, Digital Sensor

LG GC-B207CPC Rp.8289 8222 581 lt, Green Health Plus, Moist Balance™ Crisper

LG GC-L207BLK Rp.12889 LED Lighting, Tall ice & water dispenser

LG GR-B207BLQ Rp.8879 581 lt, LED Temperature Control, Bio Shield, Super Cool

LG GR-B217LGJ Rp.15382 581 lt, LED Temperature Control, Bio Shield Flower Pattern

LG GR-L207BLK Rp.- 567 lt, Icebeam Door Cooling System, Water & Ice Dispenser

MODENA RF-2561 Rp.8333 618Lt, Humidity controller crisper, Multi air flow

MODENA RF-2565 Rp.14343 608Lt, LED Temperature control, Ice & water dispenser

MODENA RF-4862 Rp.16663 610Lt, 4 Doors, Fast Freeze, Active Vita Crisper

= SHOWCASE COOLER =

BRAND TYPE Rp (000) FEATURES

DOMO DS 1200 Rp.2453 200 Lt showcase display cooler, 0 °C-10 °C
DOMO DS 1250 Rp.2757 2543 250 Lt showcase display cooler, 0 °C-10 °C
DOMO DS 1300 Rp.2853 300 Lt showcase display cooler, 0 °C-10 °C
DOMO DS 1400 Rp.3354 400 Lt showcase display cooler, 0 °C-10 °C
GEA EXPO 50 Rp.1491 50 Lt, 2°C – 8°C, fan cooling system, 1shelf
GEA EXPO 90 Rp.1991 90 Lt, 2°C – 8°C, fan cooling system, 4 shelves
GEA EXPO 136 Rp.2221 136 Lt, 2°C – 8°C, fan cooling system, 3 shelves
GEA EXPO 218HS Rp.2951 210 Lt, 2°C – 8°C, fan cooling system, 4 shelves
GEA EXPO 268HS Rp.3076 260 Lt, 2°C – 8°C, fan cooling system, 5 shelves
GEA EXPO 280P Rp.3471 280 Lt, 2°C – 8°C, No Frost Premium series, 4 shelves
GEA EXPO 368HS Rp.3481 360 Lt, 2°C – 8°C, fan cooling system, 5 shelves
GEA EXPO 450P Rp.5476 400 Lt, 2°C – 8°C, No Frost Premium series, 5 shelves
GEA EXPO 480 Rp.6332 6221 480 Lt, 2°C – 8°C, No Frost Premium, 6 shelves
GEA EXPO 200 Rp.- 200 Lt, 2°C – 8°C, fan cooling system, 3 shelves
GEA EXPO 250 Rp.- 250 Lt, 2°C – 8°C, fan cooling system, 5 shelves
GEA EXPO 350 Rp.- 350 Lt, 2°C – 8°C, fan cooling system, 5 shelves
GEA EXPO 420DD Rp.- 420 Lt, 2°C – 8°C, fan cooling system, 5 shelves
MODENA SC-1130 Rp.2048 130 Lt showcase display cooler, 0 °C-10 °C
MODENA SC-1150 Rp.2281 150 Lt showcase display cooler, 0 °C-10 °C
MODENA SC-1180 Rp.2423 180 Lt showcase display cooler, 0 °C-10 °C
MODENA SC-1200 Rp.- 200 Lt showcase display cooler, 0 °C-10 °C
MODENA SC-1260 Rp.3740- 2953 260 Lt showcase display cooler, 0 °C-10 °C
MODENA VM-1320 Rp.- 320 Lt showcase display cooler, 0 °C-10 °C
MODENA VM-1350 Rp.3583 350 Lt showcase display cooler, 0 °C-10 °C
MODENA VM-1380 Rp.- 380 Lt showcase display cooler, 0 °C-10 °C
MODENA VM-1410 4982 4084 410 Lt showcase display cooler, 0 °C-10 °C
POLYTRON SCP-122LE Rp.2328 Big capacity, Non CFC, Low energy consumption
POLYTRON SCP-123 Rp.2448 Big capacity, Non CFC, Low energy consumption, Bottle
opener
POLYTRON SCP-150 Rp.2528 180 Lt, Non CFC, Low energy consumption, 540x660x1525mm
POLYTRON SCP-151 Rp.2559 Big capacity, Non CFC, Low energy consumption, Bottle
opener
POLYTRON SCP-156T Rp.2480 170Lt, IPM LED Timer, 3 Shelves
POLYTRON SCP-157T Rp.2580 170Lt, IPM LED Timer, 3 Shelves, Bottle opener,
Door handle
POLYTRON SCP-161 Rp.2728 180 Lt, 3 Shelves, Bottle opener, No Frost
POLYTRON SCP-1170 Rp.2687 230 Lt, Non CFC, Low energy consumption,
540x660x1785mm
POLYTRON SCP-1171 Rp.2788 Big capacity, Non CFC, Low energy consumption, Bottle
opener
POLYTRON SCP-1181 Rp.2968 230 Lt, 4 Shelves, Bottle opener, No Frost
SANSIO SAN-238SC Rp.3543 4 Shelves, 55 x 54 x 177 cm
SANSIO SAN-288SC Rp.3853 4 Shelves, 58 x 61 x 182 cm
SANSIO SAN-368SC Rp.4283 4 Shelves, 58 x 61 x 198 cm
SANSIO SAN-278SC Rp.4543 4 Shelves Premium series display showcase cooler
SANSIO SAN-378SC Rp.4993 5 Shelves Premium series display showcase cooler
SANSIO SAN-248 Rp.- 248 Lt, 4 Shelves, Premium series display showcase cooler
SANSIO SAN-338 Rp.- 338 Lt, 5 Shelves, Premium series display showcase cooler
SANSIO SAN-428SC Rp.5733 408 Lt, 5 Shelves, Premium series display showcase
cooler

SANSIO SAN-888 Rp.8943 888 Lt, 2 Doors, 10 Shelves, 0° to +10°C
SANSIO SAN-1188 Rp.9953 1188 Lt, 2 Doors, 10 Shelves, 0° to +10°C
SANSIO SAN-1488 Rp.1488 Lt, 2 Doors, 10 Shelves, 0° to +10°C

Back to top

= CHEST FREEZER =

BRAND TYPE Rp (000) FEATURES

DOMO DF 1100 Rp.1644 100 Lt chest freezer, - 18°C
DOMO DF 1155 Rp.1829 155 Lt chest freezer, - 18°C
DOMO DF 1205 Rp.2044 205 Lt chest freezer, - 25°C
DOMO DF 1300 Rp.2734 300 Lt chest freezer, - 25°C
GEA AB-108 Rp.1972 105 Lt, - 28°C, Lock
GEA AB-201TX Rp.2629 194 Lt, - 28°C, Lock
GEA AB-201TC Rp.3081 194 Lt, - 28°C, Lock, suhu bisa dirubah ke chiller +2°
s/d +8°C
GEA AB-271 Rp.3151 295 Lt, - 28°C, Lock
GEA AB-396T Rp.4121 386 Lt, - 28°C, Lock
GEA AB-506T Rp.4831 492 Lt, - 28°C, Lock
GEA AB-600T Rp.5341 607 Lt, - 28°C, Lock
GEA AB-600TC Rp.6521 607 Lt, - 28°C, Lock
GEA AB-750T Rp.5961 750 Lt, - 28°C, Lock
MODENA MD-10 Rp.2188 100 Lt chest freezer, - 25°C
MODENA MD-15 Rp.2383 155 Lt chest freezer, - 25°C
MODENA MD-20A Rp.2695 205 Lt chest freezer, - 25°C
MODENA MD-30 Rp.3883 300 Lt chest freezer, - 25°C
MODENA MD-45 Rp.5033 450 Lt chest freezer, - 25°C
MODENA MD-60 Rp.5433 600 Lt chest freezer, - 25°C
MODENA MD-75 Rp.6783 750 Lt chest freezer, - 25°C
MODENA MD-95 Rp.8983 950 Lt chest freezer, - 25°C
SANSIO SAN-148F Rp.2033 142 Lt, Temperatur range: -25° to -32°C
SANSIO SAN-218F Rp.2543 215 Lt, Temperatur range: -25° to -32°C
SANSIO SAN-318F Rp.3343 318 Lt, Temperatur range: -25° to -32°C
SANSIO SAN-418F Rp.4543 418 Lt, Temperatur range: -25° to -32°C
SANSIO SAN-518F Rp.5653 518 Lt, Temperatur range: -25° to -32°C
SANSIO SAN-618F Rp.5399 618 Lt, Temperatur range: -25° to -32°C
SANSIO SAN-818F Rp.7273 818 Lt, Temperatur range: -25° to -32°C
SANSIO SAN-1288F Rp.- 1188 Lt, Temperatur range: -25° to -32°C
SANYO SF-C11KW Rp.1939 108 Lt, Key lock, Non CFC
SANYO SF-C15KW Rp.2039 150 Lt, Key lock, Non CFC
SANYO SF-C18KW Rp.2139 178 Lt, Key lock, Non CFC
SANYO SF-C21KW Rp.2439 208 Lt, Key lock, Non CFC
SANYO SF-C24KW Rp.2669 245 Lt, Key lock, Non CFC
SANYO SF-C30KW Rp.3249 298 Lt, Key lock, Non CFC

Back to top

= SLIDING GLASS FREEZER =

BRAND TYPE Rp (000) FEATURES

GEA SD-100 Rp.1871 Sliding flat glass,100 Lt, -18 to - 25°C
GEA SD-132P Rp.2191 Sliding flat glass,132 Lt, -18 to - 25°C
GEA SD-186 Rp.2371 Sliding flat glass,186 Lt, -18 to - 25°C
GEA SD-260BY Rp.3891 Sliding curve glass, 260 Lt, -15 to - 20°C
GEA SLD-200 Rp.3172 Sliding curve glass, 200 Lt, -18 to - 25°C

GEA SLD-258 Rp.- Sliding curve glass, 258 Lt, -18 to - 25°C
GEA SLD-308 Rp.4122 Sliding curve glass, 308 Lt, -18 to - 25°C
GEA SLD-388 Rp.4922 Sliding curve glass, 388 Lt, -18 to - 25°C
MODENA MC-23 Rp.4012 Sliding curve glass, 230 Lt freezer, - 25°C
MODENA MC-30 Rp.4627 Sliding curve glass, 300 Lt freezer, - 25°C
SANSIO SAN-268SF Rp.3683 Sliding curve glass, 268 Lt, -18° to -25°C
SANSIO SAN-308SF Rp.4383 Sliding curve glass, 308 Lt, -18° to -25°C
LG GN-V262RVC 260 lt, Vit + Ion, Multi Airflow Cooling System
LG GN-V282RLC 290 lt, , Multi Airflow, Moist Balance Crisper –
LG GN-V282RLCT 253 lt, Vitamin Plus, Moist Balance Crisper
LG GN-V282RVC 290 lt, Vit + Ion, Multi Airflow Cooling System –
LG GN-V282RNB 290 lt, Vit + Ion, Multi Airflow Cooling System –
LG GN-B352CLC 291lt Nett capacity, Vitamin Plus, Ion Carbon Deodoriser
LG GN-B352YVC 350 lt, Bio Shield, Green Ion Door Cooling, Vitamin Plus
LG GN-B392CLC 321lt Nett capacity, Vitamin Plus, Ion Carbon Deodoriser
LG GN-B392YLC 380 lt, Bio Shield, Vitamin Plus, Green Ion deodorizer
LG GN-B492CLC 393 lt Nett capacity, Vitamin Plus, Ion Carbon Deodoriser
LG GN-M352CLN 288 lt Nett capacity, Bio Shield, Vitamin Plus, LED display
LG GN-M352CPC 288 lt Nett capacity, Door Cooling, Vit Plus, Green Ion Deo, Flora finishing
LG GN-M352YPC 315 lt, Bio Shield, Vitamin Plus, Green Ion deodorizer –
LG GN-M392CPC 318 lt Nett capacity, Door Cooling, Vit Plus, Green Ion Deo, Flora finishing
LG GN-M392YLQ 346 lt, Bio Shield, Vitamin Plus, Green Ion door cooling –
LG GN-M392YPC 346 lt, Bio Shield, Vitamin Plus, Green Ion deodorizer –
LG GN-M492CLN 388 lt Nett capacity, Bio Shield, Vitamin Plus, LED display
LG GN-M492CPC 388 lt Nett capacity, Door Cooling, Vit Plus, Green Ion Deo, Flora finishing
LG GN-M492YPC 422 lt, Bio Shield, Vitamin Plus, Green Ion deodorizer –
LG GR-B352CLC 350 lt, Bio Shield, Vitamin Plus, Z-Deodoriser
LG GR-B392YLC 339 lt, Green Ion Door Cooling, Vitamin Plus, Deo –
LG GR-B492CLC 470 lt, Bio Shield, Vitamin Plus, Z-Deodoriser
LG GR-B492YLC 393 lt, Bio Shield, Vitamin Plus, Z-Deodorizer –
LG GR-B562YLC 428 lt, Bio Shield, Vitamin Plus, Carbon deodorizer
LG GR-B602YLC 660 lt, Bio Shield, Vitamin Plus, Carbon deodorizer
LG GR-M562YSQ 423 Lt netto, Wide LED Temperature Control, Vitamin Plus, Green ion Deodorizer
LG GR-M602YSQ 463 Lt netto, Wide LED Temperature Control, Vitamin Plus, Green ion Deodorizer
LG GR-M652YSQ 566 Lt, Wide LED Temperature Control, Vitamin Plus, Green ion Deodorizer
LG GR-M712YLA 710 Lt, Wide LED Temperature Control, Vitamin Plus, Green ion Deodorizer, Door Alarm –
LG GR-M712YSQ 640 Lt, Wide LED Temperature Control, Vitamin Plus, Green ion Deodorizer
PANASONIC NR-B21KX 200 lt, 99w, Organix Antibacteria Cassette,
PANASONIC NR-B23CF-S 195 lt, 99w, DEON (Honey Comb Deodorizer & Ion)
PANASONIC NR-B25BF-S 229 lt, 110w, DEON (Honey Comb Deodorizer & Ion)
PANASONIC NR-B25GF-S 229 lt, 110w, DEON (Honey Comb Deodorizer & Ion)
PANASONIC NR-B203G 204 lt, MagicTop, N- Bio Deodorizer

PANASONIC NR-B243G 234 lt, MagicTop, N-Bio Deodorizer
PANASONIC NR-B283G 279 lt, MagicTop, N-Bio Deodorizer
PANASONIC NR-B363M 355 lt, Multi Hygienic System , MagicTop
PANASONIC NR-B403V Import/Complete Built-up, 395lt, MagicTop, Inverter
PANASONIC NR-B591 Import/Complete Built-up, 506 lt, MagicTop –
PANASONIC NR-BW414VSWA 418 lt, Inverter – saving 40% energy, MagicTop
PANASONIC NR-BW464VSWA 463 lt, Inverter – saving 40% energy, MagicTop
PANASONIC NR-BY551XSWA 495 lt, Inverter – saving 40% energy, MagicTop
PANASONIC NR-BW601XSWA 546 lt, Inverter – saving 40% energy, MagicTop
SAMSUNG RT-2A SDIS 230 Lt, Cool Pack, Silver Nano deodorizer
SAMSUNG RT-2A SATS 230 Lt, Cool Pack, Silver plus deodorizer
SAMSUNG RT-2A SDSS 230 Lt, Cool Pack, Silver Nano deodorizer
SAMSUNG RT-2A SDTS 230 Lt, Cool Pack, Silver plus deodorizer
SAMSUNG RT-2B SATS 280 Lt, Cool Pack, Silver Plus deodorizer, Coolever zone
SAMSUNG RT-2B SDTS 280 Lt, Cool Pack, Silver Nano deodorizer, Coolever zone
SAMSUNG RT-30SCTS 300 Lt, Big Plus, Cool Pack, Silver Plus deodorizer
SAMSUNG RT-30SSIS 300 Lt, Evergreen Zone, Cool Pack, Silver Plus deodorizer
SAMSUNG RT-30SSPN 300 Lt, Evergreen Zone, UV Chilled Room, Silver Plus deo
SAMSUNG RT-37SCTS 370 Lt, Big Plus, Cool Pack, Silver Plus deodorizer
SAMSUNG RT-37SSPN 370 Lt, Evergreen Zone, UV Chilled Room, Silver Plus deo
SAMSUNG RT-41MAIS 410 Lt, i-Cool, Coolever Zone, Silver Nano deodorizer
SAMSUNG RT-45MAIS 450 Lt, i-Cool, Coolever Zone, Silver Nano deodorizer
SANYO SR-D225N 179 lt, Nano Ferrite Filter, Carbon deodorizer
SANYO SR-D245N 216 lt, Nano Ferrite Filter, Carbon deodorizer
SHARP SJ-F201S-RD SAMURAI series, 170 lt, Anti bacteria
SHARP SJ-F231S-RD SAMURAI series, 180 lt, Anti bacteria
SHARP SJ-F200G Fresh Lemon Series Refrigerator, Low Voltage –
SHARP SJ-F200M Fresh Lemon Series Refrigerator, Low Voltage –
SHARP SJ-F201G Fresh Lemon Series Refrigerator, Low Voltage –
SHARP SJ-F201M Fresh Lemon Series Refrigerator, Low Voltage –
SHARP SJ-F231G Fresh Lemon Series Refrigerator, Low Voltage –
SHARP SJ-F231M Fresh Lemon Series Refrigerator, Low Voltage –
SHARP SJ-D22LV-SL 195 lt, Lemon Series Refrigerator, Low Voltage
SHARP SJ-D27LV-SL 210 lt, Lemon Series Refrigerator, Low Voltage
SHARP SJ-D30LV-SL 235 lt, Lemon Series Refrigerator, Low Voltage
SHARP SJ-291NLV-SL 260 lt, Lemon Series Refrigerator, Low Voltage –
SHARP SJ-351NLV-SL 300 lt, Lemon Series Refrigerator, Low Voltage
SHARP SJ-431NLV-SL 320 lt, Lemon Series Refrigerator, Low Voltage
SHARP SJ-460NLV 367 lt, SALSA Series Refrigerator, Nano Deodorizer –
SHARP SJ-461NLV 367 lt, SALSA Series Refrigerator, Hybrid Cooling System
SHARP SJ-P450NLV 370 lt, Plasmacluster Ion System
SHARP SJ-P461NLV 443 lt, SALSA Series Refrigerator, Plasmacluster Ion System
SHARP SJ-560NLV 367 lt, SALSA Series Refrigerator, Nano Deodorizer –
SHARP SJ-561NLV 397 lt, SALSA Series Refrigerator, Hybrid Cooling System
SHARP SJ-P510NLV 409 lt, Plasmacluster Ion System
SHARP SJ-P561NLV 478 lt, SALSA Series Refrigerator, Plasmacluster Ion System
SHARP SJ-580NLV 437 lt, SALSA Series Refrigerator, Hybrid Cooling System –
SHARP SJ-P580NLV 375 lt, Lemon Series no frost with plasma cluster
SHARP SJ-P581NLV 437 lt, SALSA Series Refrigerator, Hybrid Cooling System,
Plasmacluster, Advance LEC Control, Nano Deodorizer

SHARP SJ-650NLV 473 lt, SALSA Series Refrigerator, Hybrid Cooling System –
SHARP SJ-P651NLV 473 lt, SALSA Series Refrigerator, Hybrid Cooling System,
Plasmacluster, Advance LEC Control, Nano Deodorizer
SHARP SJ-750NLV 514 lt, SALSA Series Refrigerator, Hybrid Cooling System –
SHARP SJ-P750NLV 514 lt, SALSA Series Plasmacluster Refrigerator –
SHARP SJ-P751NLV 514 lt, SALSA Series Refrigerator, Hybrid Cooling System,
Plasmacluster, Advance LEC Control, Nano Deodorizer
SHARP SJ-P812NLV 524 lt, Plasmacluster Ion System –
SHARP SJ-850NLV 555 lt, SALSA Series Refrigerator, Hybrid Cooling System –
SHARP SJ-P851NLV 555 lt, SALSA Series Refrigerator, Hybrid Cooling System,
Plasmacluster, Advance LEC Control, Nano Deodorizer
TOSHIBA GR-K242 180 lt, 75W
TOSHIBA GR-K242PD 180 lt, 75W, Platinum Deodorizer
TOSHIBA GR-K262 216 lt, 90W
TOSHIBA GR-K262PD 216 lt, 90W, Platinum Deodorizer
TOSHIBA GR-M245E 180 lt, No Frost
TOSHIBA GR-M245D 180 lt, No Frost, Deodorizer
TOSHIBA GR-M265D 216 lt, No Frost, Deodorizer
TOSHIBA GR-R21ET Import, 180 lt, Health series, Platinum Deodorizer
TOSHIBA GR-R25ET Import, 228 lt, Health series, Platinum Deodorizer
TOSHIBA GR-R34ED Import/Complete Built-up, 280 lt, Hybrid Plasma Deo
TOSHIBA GR-R39ED Import/Complete Built-up, 320 lt, Hybrid Plasma Deo
TOSHIBA GR-RG43ED Import, 355 lt, Hybrid Plasma Deo, Glass door
TOSHIBA GR-R48ED Import, 401 lt, Hybrid Plasma Deo
TOSHIBA GR-RG48ED Import, 410 lt, Hybrid Plasma Deo, Glass door
TOSHIBA GR-R58ED Import/Complete Built-up, 500 lt, Hybrid Plasma Deo
TOSHIBA GR-R66ED Import/Complete Built-up, 590 lt, Hybrid Plasma Deo
TOSHIBA GR-RG58ED Import, 500 lt, Hybrid Plasma Deo, Glass door
TOSHIBA GR-RG66ED Import, 590 lt, Hybrid Plasma Deo, Glass door
KULKAS 3 PINTU / 3 DOORS REFRIGERATOR
ELECTROLUX ETB-2603PC Deo Fresh Active, Multi Airflow System
TOSHIBA GR-R47EDV Import/Complete Built-up, 3 doors, 470 lt
SIDE-BY-SIDE REFRIGERATOR
ELECTROLUX ERE-6100SX 580 lt, Fully Electronic Control with LCD Display, Wine
rack
LG GR-A207WPJ 581 lt, Green LED, In-Door Ice Maker
LG GR-B207FLC 581 lt, Bio Shield, Moist Balance™ Crisper
LG GR-B207WLQ 581 lt, LED Temperature Control, Bio Shield
LG GR-B217LGJ 581 lt, LED Temperature Control, Bio Shield Flower Pattern
LG GR-L207WLK 567 lt, Tall Ice & Water Dispenser
LG GR-R207WTC 584 lt, Electric Control with 6 Sensor



Private Picture Copyright : WWW.MBSM.PRO

Mbsm_dot_pro_private_PDF_lg-gr-b562ylc-owner-s-manualTélécharger



REFRIGERATOR-FREEZER
MODEL No.: GR-B562YLC

CLIMATE CLASS	T
RATING	220V ~ 50/60Hz
RATED CURRENT	0.6A
DEFROSTING INPUT	230W
RATED INPUT OF HEATER CORD	165W
RATED INPUT MAXIMUM OF LAMP	
FREEZER COMPARTMENT	20W
FRESH FOOD COMPARTMENT	30W
INSULATION BLOWING AGENT	Cyclopentane
NET WEIGHT	85kg
REFRIGERANT	R134a 135g
DIMENSIONS	755(W)x707(D)x1777(H)mm
SERIAL No.:	Refer to bar code label.

MADE IN INDONESIA

MEZ40001987

Private Picture Copyright : WWW.MBSM.PRO

Application Deep Freezer	MA88LAEP
Fridge Compressor – Capacity	410 – 450 liters
Displacement	8.8
Cooling Capacity	235 (kcal/h), 273W, 933 (Btu/h), 0.367HP
Input Power	227W
COP W/W	1.2
EER Btu/Wh	4.11
Motor type	CSIR-Relay
Starting Device (PTC)	QL2-5-55
Motor Protector (OLP)	4TM314TFB
(Capacitor) Starting/Surge Voltage	50 / 275
(OIL) Viscosity cst/ Qty(cc)	22/220
Cooling type	FC
Compressor Height	177mm

Net Weight

9.3 kg.

Compressor, LG, GK113P, R410A,
220-240V, 50Hz, 9600 Btu / h,
capacitor 35 uF, 1Piston

Category: compressor

written by www.mbsm.pro | 13 December 2021



Private Picture Copyright: WWW.MBSM.PRO

Refrigerant	Type	Frequency	Voltage	Series	Model	Cooling	Capacity	Input	EER	COP	Test Condition
Btu/hr	Watts	Watts	Btu/W.hr	W/W							
R410A	1piston	50Hz	1 Φ , 220/240V	GA	GA066P	5,270	1,544	555	9.5	2.78	ASHRAE
GA080P		6,550	1,919	668	9.81	2.87					ASHRAE
GA086P		7,050	2,066	735	9.59	2.81					ASHRAE
GAB	GAB040P	3,130	917	340	9.2	2.7					ASHRAE

GAB042P	3,410	999	355	9.6	2.81	ASHRAE	
GAB048P	3,985	1,168	403	9.9	2.9	ASHRAE	
GAB072P	5,950	1,744	590	10.08	2.95	ASHRAE	
GK	GK086P	6,900	2,022	726	9.5	2.79	ASHRAE
GK094P	7,700	2,256	794	9.7	2.84	ASHRAE	
GK102P	8,250	2,418	841	9.81	2.87	ASHRAE	
GK113P	9,000	2,637	914	9.85	2.89	ASHRAE	
GK120P	9,700	2,842	1,010	9.6	2.81	ASHRAE	
GK141P	11,350	3,326	1,170	9.7	2.84	ASHRAE	
GK151P	12,200	3,575	1,245	9.8	2.87	ASHRAE	
GKS	GKS094P	7,700	2,256	755	10.2	2.99	ASHRAE
GKS108P	8,700	2,549	838	10.38	3.04	ASHRAE	
GKS113P	8,750	2,564	920	9.51	2.79	ASHRAE	
GKS134P	10,900	3,194	1,100	9.91	2.9	ASHRAE	
GKS141P	11,500	3,370	1,116	10.3	3.02	ASHRAE	
GKS151P	12,230	3,584	1,245	9.82	2.88	ASHRAE	
GJ	GJ176P	14,400	4,220	1,485	9.7	2.84	ASHRAE
GJ196P	16,500	4,835	1,705	9.68	2.84	ASHRAE	
GJ208P	17,500	5,128	1,750	10	2.93	ASHRAE	
GJ222P	18,500	5,421	1,867	9.91	2.9	ASHRAE	
GJ230P	19,100	5,597	1,949	9.8	2.87	ASHRAE	



Private Picture Copyright : WWW.MBSM.PRO

Mbsm_dot_pro_private_PDF_gk113pTélécharger

Compressor, LX110LQJG, Refrigeration freezer, KF-P8903HLP, 1/3HP, 260W, R134A, 180G, Refrigerator Amercain

Category: compressor

written by www.mbsm.pro | 13 December 2021



Private Picture Copyright : WWW.MBSM.PRO

1 Reciprocating & Linear Compressor Compressor Technology for Refrigerator
2 01 LG Compressor Model Variety In order to offer you a various product portfolio of refrigerator compressor, our range covers constant and inverter of Reciprocating and Linear compressor with low pressure as well as high pressure. It enables to provide you with full support in all application of your needs. Customer Support LG compressors promise to deliver a satisfaction level for all your business stage from research, development to the spec-in that exceeds our customers expectations, and strives to provide the highest value to our customers through a fast, accurate and differentiated service & solution as your

business partner. Technology LG compressors are continuously evolving group of high-precision machining and assembly technologies from accumulated techniques for generating sustainable world best compressor. Especially we are enabling to give our customers technical support in order to provide best performance compressor through design mechanism and produce key technology of compressor, inverter motor and drive that makes you to achieve optimized product. Quality With the product quality and safety evaluation system that performs basic quality and safety evaluation for products at every production stage. Under the quality gate system, all our products undergo a safety check at each quality gate based on a checklist, preventing shipments of products with quality or safety issues. We also have achieved recognition our quality and sustainability from Europe, North America, China and Japan. Why LG Compressor? LG Compressor 01 3 02 LG Compressor LG Compressor 03 Brief History & Factory Milestones & Production Sites China Qinhuangdao (Casting) Tianjin (Rotary, Scroll) Nanjing () Taizhou (Reciprocating) 13 Production Refrigerator Compressor Production Air-conditioner Compressor Production Compressor Division Compressor Sales 100 Million Units Establishment of C&M Business Unit 2011 Korea (HQ) Changwon (Reciprocating, Linear, Rotary, Scroll,) India Noida (Reciprocating) Thailand Rayong (Rotary)

4 04 LG Compressor LG Compressor 05 Contents Why LG Compressor? Brief History & Factory Reciprocating Compressor – Product Range – Nomenclature – Specification I Constant speed – Specification I Inverter – Specification I Controller – Attached / Detached Controller – Mounting – Packing & Container Stuffing Quantity Linear Compressor – Product Range – Nomenclature – Specification – Wiring Diagram – Accessory Part – Packing & Container Stuffing Quantity 5 08 LG Reciprocating Compressor LG Reciprocating Compressor 09 Nomenclature Product type B : BLDC C : Constant Speed F : Linear Size C : Compact L : Large M : Medium S : Small Generation code (A-Z) B M A 098 N A M V Operating type Rated voltage & frequency Code Voltage Hz Code Voltage Hz A /60 Q 110~ B 50/60 R 110~ C D 60 E ~ S T Code Voltage G RSIR M RSCR F CSIR H CSR K RSIR N RSCR P CSIR R CSR V Inverter 200~ ~ F J 60 U 115~ K M ~240 50/60 L N 115~127 50/60 P Improvement order A, B, C : Cu Wire H, J : Al Wire R134a TS Capacity EER COP TS22LHEG RSIR ~240/ ASHRAE TS22LHAG RSIR 110/ ASHRAE TS24LATG RSIR ~240/ ASHRAE TS24LJJG RSIR / ASHRAE TS24LHJG RSIR / ASHRAE TS24LAAG RSIR 110/ ASHRAE TS24LHAG RSIR 110/ ASHRAE TS24LHTG RSIR ~240/ ASHRAE TS22LHAG RSIR 110/ ASHRAE TS22LHDG RSIR / ASHRAE TS22LHCG RSIR 115/ ASHRAE TS24LADG RSIR / ASHRAE TS24LATG RSIR / ASHRAE TS24LAAG RSIR 100/ ASHRAE TS24LHAG RSIR 110/ ASHRAE TS24LHUG RSIR 115~127/ ASHRAE TS24LAFG RSIR 127/ ASHRAE TS24LBDM RSCR / ASHRAE TS24LACG RSIR 115/ ASHRAE TS24LHDG RSIR / ASHRAE TS24LHTG RSIR / ASHRAE Note 2 : condition Evaporating temperature Condensing temperature Ambient temperature TS Capacity Displacement (ex : 098=9.8cc/rev) Refrigerants L : R134a H : R134a HBP N : R600a 6 10 LG Reciprocating Compressor LG Reciprocating Compressor 11 R134a NS Capacity EER COP NS24LBEG RSIR ~240/ ASHRAE 157 NS24LABG RSIR / ASHRAE 147 NS24LAEG RSIR ~240/ ASHRAE 147 NS24LABG RSIR / ASHRAE 147 NS24LBCG RSIR 115/ ASHRAE 157 NS24LBCM RSCR 115/ ASHRAE 157 NS24LADG RSIR / ASHRAE 147 NS24LACG RSIR 115/ ASHRAE 147 NS30LABG RSIR / ASHRAE 147 NSA24LACG RSIR 115/ ASHRAE 147 NS30LAEG RSIR ~240/ ASHRAE 147 NS30LABG RSIR / ASHRAE 147 NS36LABG RSIR / ASHRAE 157 NS30LACG RSIR 115/ ASHRAE 147 NS30LACM RSCR 115/ ASHRAE 147 NS36LAEG RSIR ~240/ ASHRAE 157 NSA30LACG RSIR 115/ ASHRAE 147 NS36LACG RSIR 115/ ASHRAE 157 NS36LADG RSIR / ASHRAE 157 NS36LADM RSCR / ASHRAE 157 NS36LABG RSIR / ASHRAE 157

NSA36LACG RSIR 115/ ASHRAE 157 R134a CMA Capacity EER COP CMA042LHJG RSIR / ASHRAE 171 CMA042LHDM RSCR / ASHRAE 171 CMA042LHCG RSIR 115/ ASHRAE 171 CMA042LHCM RSCR 115/ ASHRAE 171 CMA042LHUM RSCR 115~127/ ASHRAE 171 CMA053LHEG RSIR ~240/ ASHRAE 171 CMA053LHEM RSCR ~240/ ASHRAE 171 CMA057LHEM RSCR ~240/ ASHRAE 171 CMA057LHEG RSIR ~240/ ASHRAE 171 CMA057LAEM RSCR ~240/ ASHRAE 171 CMA053LHDG RSIR / ASHRAE 171 CMA053LHCG RSIR 115/ ASHRAE 171 CMA053LHCM RSCR 115/ ASHRAE 171 CMA062LHEG RSIR ~240/ ASHRAE 171 CMA062LHEM RSCR ~240/ ASHRAE 171 CMA069LAEM RSCR ~240/ ASHRAE 171 CMA069LBEM RSCR ~240/ ASHRAE 171 CMA069LHEM RSCR ~240/ ASHRAE 171 CMA075LHDM RSCR / ASHRAE 171 Note 2 : condition Evaporating temperature Condensing temperature Ambient temperature Note 2 : condition Evaporating temperature Condensing temperature Ambient temperature NS CMA

7 12 LG Reciprocating Compressor LG Reciprocating Compressor 13 R134a MA Capacity EER COP MA42LPJG RSIR / ASHRAE 172 MA42LMJM RSCR / ASHRAE 172 MA42LMJG RSIR / ASHRAE 172 MA42LHJM RSCR / ASHRAE 172 MA45LDJG RSIR / ASHRAE 172 MA45LCJG RSIR / ASHRAE 172 MA45LJJM RSCR / ASHRAE 172 MA45LHJM RSCR / ASHRAE 172 MA53LABM RSCR / ASHRAE 172 MA53LATG RSIR ~240/ ASHRAE 172 MA53LAJM RSCR / ASHRAE 172 MA53LJJG RSIR / ASHRAE 172 MA53LBJG RSIR / ASHRAE 172 MA53LAJG RSIR / ASHRAE 172 MA53LAEG(AL) RSIR ~240/ ASHRAE 180 MA53LAEM(AL) RSCR ~240/ ASHRAE 180 MA57LBJG RSIR / ASHRAE 172 MA57LABM RSCR / ASHRAE 180 MA57LAEG RSIR ~240/ ASHRAE 172 MA57LAEM(AL) RSCR ~240/ ASHRAE 180 MA57LBEG(AL) RSIR ~240/ ASHRAE 180 MA57LBJG RSIR / ASHRAE 177 MA57LJJG RSIR / ASHRAE 177 MA53LHEM RSCR ~240/ ASHRAE 172 MA57LDJM RSCR / ASHRAE 177 MA53LBCG RSIR 115/ ASHRAE 172 MA53LBCM RSCR 115/ ASHRAE 172 MA62LCEG RSIR ~240/ ASHRAE 180 MA62LCEM RSCR ~240/ ASHRAE 180 MA62LDEG RSIR ~240/ ASHRAE 172 MA53LAUG RSIR 115~127/ ASHRAE 172 MA62LBJG RSIR / ASHRAE 177 MA62LJJG RSIR / ASHRAE 177 MA62LDJM RSCR / ASHRAE 177 MA62LBEG RSIR ~240/ ASHRAE 177 MA62LCEG RSIR ~240/ ASHRAE 177 MA53LADG RSIR / ASHRAE 172 MA53LADM RSCR / ASHRAE 172 MA53LCCM RSCR 115/ ASHRAE 172 MA53LABM RSCR / ASHRAE 172 MA69LKEM RSCR ~240/ ASHRAE 177 MA69LJEG RSIR ~240/ ASHRAE 177 MA69LJEP CSIR ~240/ ASHRAE 177 MA69LHEM RSCR ~240/ ASHRAE 177 MA69LHEG RSIR ~240/ ASHRAE 177 R134a MA / MC MA MC LQ Capacity EER COP MA69LHEP CSIR ~240/ ASHRAE 177 MA57LADM RSCR / ASHRAE 180 MA57LABM RSCR / ASHRAE 180 MA69LDEG RSIR ~240/ ASHRAE 172 MA69LCEG RSIR ~240/ ASHRAE 180 MA69LCEM RSCR ~240/ ASHRAE 180 MA69LAEM RSCR ~240/ ASHRAE 177 MA72LBJG RSIR / ASHRAE 177 MA72LHEM RSCR ~240/ ASHRAE 177 MA72LKEM RSCR ~240/ ASHRAE 177 MA72LBEM RSCR ~240/ ASHRAE 177 MA72LJEP CSIR ~240/ ASHRAE 177 MA72LJEG RSIR ~240/ ASHRAE 177 MA72LHEG RSIR ~240/ ASHRAE 177 MA88LAEP CSIR ~240/ ASHRAE 177 MA98LAEM RSCR ~240/ ASHRAE 182 MC53LBEM RSCR ~240/ ASHRAE 172 MC57LAEM RSCR ~240/ ASHRAE 177 MC57LBEM RSCR ~240/ ASHRAE 177 MA57LBJM RSCR / ASHRAE 177 LQ75LAEM RSCR ~240/ ASHRAE 203 LQ86LAEM RSCR ~240/ ASHRAE 203 Remark LQ69LAUM RSCR 115~127/ ASHRAE 203 E-PTC LQ69LAUM RSCR 115~127/ ASHRAE 203 LQ69LAUH RSCR 115~127/ ASHRAE 203 E-PTC LQ69LADM RSCR / ASHRAE 203 LQ75LAUM RSCR 115~127/ ASHRAE 203 E-PTC LQ100LAJH CSR / ASHRAE 203 LQ86LADM RSCR / ASHRAE 203 Note 2 : condition Evaporating temperature Condensing temperature Ambient temperature LQ

8 14 LG Reciprocating Compressor LG Reciprocating Compressor 15 R134a LX Capacity EER COP LX67LABM RSCR / ASHRAE 200 LX67LHBM RSCR / ASHRAE 203 LX72LATG RSIR ~240/ ASHRAE 200 LX72LBEG RSIR ~240/ ASHRAE 200 LX72LAAM RSCR 110/ ASHRAE 200 LX72LATF CSIR ~240/ ASHRAE 200 LX72LATH CSR ~240/ ASHRAE 200 LX72LAEM RSCR ~240/ ASHRAE 200 LX72LHJH CSR / ASHRAE 203 LX72LHJM RSCR / ASHRAE 203 LX72LHJF CSIR / ASHRAE 203 LX67LAQG RSIR 100~115/ ASHRAE 200 LX86LABM RSCR / ASHRAE 203

LX86LBEG RSIR ~240/ ASHRAE 200 LX86LBEF CSIR ~240/ ASHRAE 200 LX86LCEG RSIR
~240/ ASHRAE 203 LX86LHEM RSCR ~240/ ASHRAE 203 LX86LHJF CSIR / ASHRAE 203
LX67LABM RSCR / ASHRAE 200 LX67LAFM RSCR 127/ ASHRAE 200 LX67LHBM RSCR / ASHRAE
203 LX86LPBP CSIR / ASHRAE 203 LX86LAEG RSIR ~240/ ASHRAE 203 LX72LATG RSIR /
ASHRAE 200 LX72LBQG RSIR 100~115/ ASHRAE 200 LX72LAAM RSCR 110/ ASHRAE 200
LX72LATF CSIR / ASHRAE 200 LX72LATH CSR / ASHRAE 200 LX72LHQF CSIR 100~115/
ASHRAE 203 LX95LAAH CSR 110/ ASHRAE 203 LX95LABH CSR / ASHRAE 203 LX86LACM RSCR
115/ ASHRAE 203 LX86LAQM RSCR 100~115/ ASHRAE 203 LX86LPBP CSIR / ASHRAE 203
LX86LADM RSCR / ASHRAE 203 LX86LABM RSCR / ASHRAE 203 LX86LPDP CSIR / ASHRAE 200
LX110LAJH CSR /50 2 1, ASHRAE 203 LX110LAJM RSCR /50 2 1, ASHRAE 203 LX110LAEH
CSR ~240/50 2 1, ASHRAE 203 LX110LAEM RSCR ~240/50 2 1, ASHRAE 203 LX R134a LX 1
Capacity EER COP LX110LAAH CSR 110/50 2 1, ASHRAE 203 LX110LQJG RSIR /50 2 1,
ASHRAE 200 LX110LHJH CSR /50 2 1, ASHRAE 203 LX110LAJM RSCR / , ASHRAE 203
LX95LAAH CSR 110/ , ASHRAE 203 LX95LADH CSR / , ASHRAE 203 LX95LABH CSR / ,
ASHRAE 203 LX95LBQH CSR 100~115/ , ASHRAE 203 LX95LAFH CSR 127/ , ASHRAE 203
LX95LAQH CSR 100~115/ , ASHRAE 203 LX110LAAH CSR 110/ , ASHRAE 203 LX110LPDP
CSIR / , ASHRAE 203 LX125LAJM RSCR / , ASHRAE 203 Note 2 : condition Evaporating
temperature Condensing temperature Ambient temperature
9 16 LG Reciprocating Compressor LG Reciprocating Compressor 17 R600a NS CSA
Capacity EER COP NS36NAAG RSIR 110/ ASHRAE 157 NS36NAAG RSIR 110/ ASHRAE 157
NSA43NACM RSCR 115/ ASHRAE 157 NSA43NACG RSIR 115/ ASHRAE 157 CSA043NHEG RSIR
~240/ ASHRAE 167 CSA043NHAG RSIR 110/ ASHRAE 167 CSA047NHEG RSIR ~240/ ASHRAE
167 CSA043NHAG RSIR 110/ ASHRAE 167 CSA053NHEG RSIR ~240/ ASHRAE 167 CSA057NHEG
RSIR ~240/ ASHRAE 167 CSA057NJEG RSIR ~240/ ASHRAE 157 CSA062NHAG RSIR 110/
ASHRAE 167 CSA062NHEG RSIR ~240/ ASHRAE 167 CSA057NHCG RSIR 115/ ASHRAE 167
CSA069NHAG RSIR 110/ ASHRAE 167 CSA069NHEG RSIR ~240/ ASHRAE 167 CSA062NHAG RSIR
110/ ASHRAE 167 CSA075NJEG RSIR ~240/ ASHRAE 157 CSA075NHEG RSIR ~240/ ASHRAE
167 CSA075NHEM RSCR ~240/ ASHRAE 167 CSA069NHCG RSIR 115/ ASHRAE 167 CSA069NHAG
RSIR 110/ ASHRAE 167 CSA075NHCG RSIR 115/ ASHRAE 167 R600a CMA Capacity EER COP
Remark CMA057NAAG RSIR 110/ ASHRAE 171 CMA057NAEM RSCR ~240/ ASHRAE 171
CMA057NAEM RSCR ~240/ ASHRAE 171 E-PTC CMA057NHEM RSCR ~240/ ASHRAE 171
CMA057NHEM RSCR ~240/ ASHRAE 171 E-PTC CMA062NAEM RSCR ~240/ ASHRAE 171
CMA062NAEM RSCR ~240/ ASHRAE 171 E-PTC CMA062NHEM RSCR ~240/ ASHRAE 171
CMA062NHEM RSCR ~240/ ASHRAE 171 E-PTC CMA057NAAG RSIR 110/ ASHRAE 171
CMA069NJEM RSCR ~240/ ASHRAE 171 CMA069NAEM RSCR ~240/ ASHRAE 171 CMA069NAEM
RSCR ~240/ ASHRAE 171 E-PTC CMA069NHEM RSCR ~240/ ASHRAE 171 CMA069NHEM RSCR
~240/ ASHRAE 171 E-PTC CMA069NHAM RSCR 110/ ASHRAE 171 CMA075NAEM RSCR ~240/
ASHRAE 171 CMA075NAEM RSCR ~240/ ASHRAE 171 E-PTC CMA075NHEM RSCR ~240/ ASHRAE
171 CMA075NHEM RSCR ~240/ ASHRAE 171 E-PTC CMA075NHAM RSCR 110/ ASHRAE 171
CMA069NHAM RSCR 110/ ASHRAE 171 CMA082NHEM RSCR ~240/ ASHRAE 171 CMA082NHEM RSCR
~240/ ASHRAE 171 E-PTC CMA082NJEG RSIR ~240/ ASHRAE 171 CMA082NAEM RSCR ~240/
ASHRAE 171 Note 2 : condition Evaporating temperature Condensing temperature
Ambient temperature Note 2 : condition Evaporating temperature Condensing
temperature Ambient temperature NS / MSA / CSA CMA
10 18 LG Reciprocating Compressor LG Reciprocating Compressor 19 R600a CMA
Capacity EER COP Remark CMA082NAEM RSCR ~240/ ASHRAE 171 E-PTC CMA089NHEM RSCR
~240/ ASHRAE 171 CMA089NHEM RSCR ~240/ ASHRAE 171 E-PTC CMA089NJEG RSIR ~240/
ASHRAE 171 CMA075NHAM RSCR 110/ ASHRAE 171 CMA089NAEM RSCR ~240/ ASHRAE 171
CMA089NAEM RSCR ~240/ ASHRAE 171 E-PTC CMA089NBEM RSCR ~240/ ASHRAE 171
CMA098NJEM RSCR ~240/ ASHRAE 171 CMA098NAEM RSCR ~240/ ASHRAE 171 CMA098NAEM

RSCR ~240/ ASHRAE 171 E-PTC CMA098NJEG RSIR ~240/ ASHRAE 171 CMA098NHEM RSCR
~240/ ASHRAE 171 CMA098NHEM RSCR ~240/ ASHRAE 171 E-PTC CMA098NJEM RSCR ~240/
ASHRAE 171 CMA089NHDM RSCR / ASHRAE 171 CMA089NHDM RSCR / ASHRAE 171 E-PTC
CMA110NAEM RSCR ~240/ ASHRAE 171 CMA110NAEM RSCR ~240/ ASHRAE 171 E-PTC
CMA110NAEM RSCR ~240/ ASHRAE 171 CMA110NAEM RSCR ~240/ ASHRAE 171 CMA098NARM
RSCR 110~127/ ASHRAE 171 CMA098NADM RSCR / ASHRAE 171 CMA121NAEM RSCR ~240/
ASHRAE 171 CMA121NAEM RSCR ~240/ ASHRAE 171 CMA110NADM RSCR / ASHRAE 171 R600a
MB MQ LQ Capacity EER COP MB62NJEG RSIR ~240/ ASHRAE 172 MB82NAEM RSCR ~240/
ASHRAE 177 MB82NJEG RSIR ~240/ ASHRAE 177 MB82NJEM RSCR ~240/ ASHRAE 177
MB98NJEG RSIR ~240/ ASHRAE 177 MQ88NAEM RSCR ~240/ ASHRAE 180 MQ98NAJH CSR /
ASHRAE 180 MQ98NAEM RSCR ~240/ ASHRAE 180 Remark LQ119NAEM RSCR ~240/ ASHRAE 203
E-PTC LQ119NAEM RSCR ~240/ ASHRAE 203 LQ125NAEM RSCR ~240/ ASHRAE 203 LQ140NAEM
RSCR ~240/ ASHRAE 203 LQ119NAQM RSCR 100~115/ ASHRAE 203 LQ140NAEM RSCR ~240/
ASHRAE 203 LQ140NAEH CSR ~240/ ASHRAE 203 LQ140NAEM RSCR ~240/ ASHRAE 203 E-PTC
Note 2 : condition Evaporating temperature Condensing temperature Ambient
temperature Note 2 : condition Evaporating temperature Condensing temperature
Ambient temperature CMA MB / MQ LQ
11 20 LG Reciprocating Compressor LG Reciprocating Compressor 21 Application :
HBP Application : HBP R134a CMA MA Capacity EER COP CMA042HHDM RSCR / , ASHRAE
161 CMA053HHDM RSCR / , ASHRAE 161 CMA062HAEM RSCR ~240/ , ASHRAE 171 CMA062HHDM
RSCR / , ASHRAE 171 CMA075HAEM RSCR ~240/ , ASHRAE 171 CMA075HADM RSCR /60 0 2,
ASHRAE 171 CMA089HADM RSCR / , ASHRAE 171 MA42HJEP CSIR ~240/ , ASHRAE 172
MA53HJEF CSIR ~240/ , ASHRAE 172 MA53HAEF CSIR ~240/ , ASHRAE 172 MA62HAEG RSIR
~240/ , ASHRAE 177 MA62HAEF CSIR ~240/ , ASHRAE 177 MA72HAEP CSIR ~240/ , ASHRAE
177 Note 2 : condition Evaporating temperature Condensing temperature Ambient
temperature ASHRAE 7.2 C 54.4 C 35 C R134a LX Capacity EER COP LX72HAEP CSIR
~240/ , ASHRAE 203 LX72HAEG RSIR ~240/ , ASHRAE 203 LX72HPDP CSIR /60 0 2,
ASHRAE 200 LX86HAEP CSIR ~240/ , ASHRAE 203 LX86HAEG RSIR ~240/50 5 2, ASHRAE
203 LX86HPDP CSIR / , ASHRAE 200 LX110HAEP CSIR ~240/ ,613 1, ASHRAE 203
LX110HAEM RSCR ~240/ ,772 1, ASHRAE 203 LX125HPJP CSIR / ,950 1, ASHRAE 203
LX110HPDP CSIR / ,9 1, ASHRAE 200 LX110HACF CSIR 115/ ,129 1, ASHRAE 203
LX125HPDP CSIR / ,764 1, ASHRAE 203 Note 2 : condition Evaporating temperature
Condensing temperature Ambient temperature ASHRAE 7.2 C 54.4 C 35 C CMA MA LX
[Mbsm_dot_pro_private_PDF_LX110LQJGTélécharger](#)

تعویض فن کندانسور





LG

REFRIGERATOR-FREEZER

MODEL : KF-P8903HLP

RATING	220V ~ 50Hz
CLIMATE CLASS	T
RATED CURRENT	1.73A
FREEZING CAPACITY	12.0kg/24Hr
DEFROSTING INPUT	260W
RATED INPUT OF HEATER SHEATH	260W
STORAGE/GROSS VOL. TOTAL	538 ℓ / 606 ℓ
-FREEZER COMPARTMENT	173 ℓ / 228 ℓ
-REFRIGERATOR COMPARTMENT	365 ℓ / 378 ℓ
REFRIGERANT	R134a 180g
INSULATION BLOWING GAS	CYCLOPENTANE
DIMENSIONS	894(W)x753(D)x1753(H)mm



910WRKG00805

MADE IN EUROPE
SERIAL NO.

TAB34634741

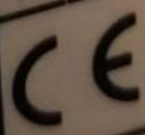



تعویض پروانه فن



 LG

LX110LQJG

R134a 1PH 220V ~ 50Hz
THERMALLY PROTECTED
RoHS LG Electronics Inc. MADE IN KOREA



P8C2220101310006

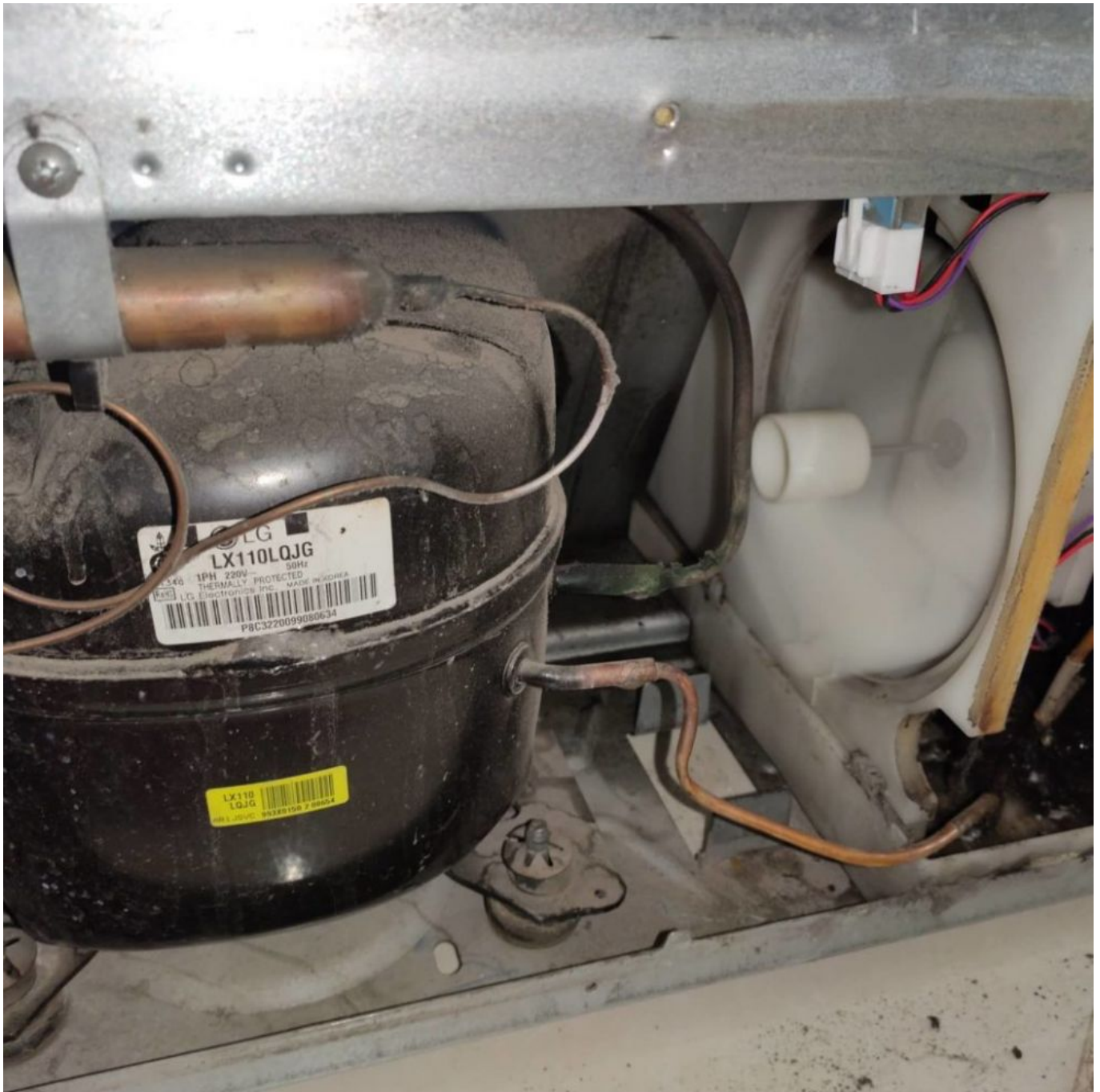

Private Picture Copyright : WWW.MBSM.PRO

Embraco, Universal, EM45HHR, R134a, Refrigeration Compressor, Low, Medium & High Back Pressure, 1/8hp, Nominal Motor HP, For use with refrigerators, ice makers, frozen food cabinets, frozen food display cases, display

windows, 115v

Category: compressor

written by www.mbsm.pro | 13 December 2021



Private Picture Copyright: WWW.MBSM.PRO

Embraco Universal EM45HHR R134a Refrigeration Compressor. Low, Medium & High Back Pressure. 1/8 Nominal Motor HP. For use with refrigerators, ice makers, frozen food cabinets, frozen food display cases, display windows, etc.

Replaces Embraco EMI40HNR and EM45HNR and Tecumseh AEA3417YXA.

Motor: Resistive Start Inductive Run & Captive Start Inductive Run (RSIR/CSIR)

Evaporating Temperatures: -10°F to 45°F

Product Specifications

BTU Capacity HBP:	1775
BTU Capacity LBP & MBP:	420
Horsepower (HP):	1/8
Locked Rotor Amps (LRA):	17.0
Motor Type:	RSIR/CSIR
Required Refrigerant :	R134a
Skill Level:	
Starting Torque:	Normal
Volts (V):	115

[Mbsm_dot_pro_private_PDF_EM45HHR-1Télécharger](#)

[Mbsm_dot_pro_private_PDF_EM45HHRTélécharger](#)

unit #
7511

TRUE®
True Manufacturing Co., Inc.
True Refrigeration®
O'Fallon, MO 63366

CABINET SERIAL NUMBER: **8947049**

8947049



MADE IN THE USA

MODEL: **GDM - 06 - LD**

115	V	HP COMPRESSOR M/N:	1/8 EM45HHR
60	Hz	REFRIGERANT:	R134A
1	PH	DESIGN PRESSURES - PSIG (kPa)	HIGH SIDE 370 LOW SIDE 140
2.3	A		

REFRIGERANT: 5 Oz. (g)

DBG

BLOWING AGENT: R611
U.S. PATENT NUMBERS:

THIS UNIT LISTED UNDER N.S.F. NO. 7
FOR THE STORAGE AND/OR DISPLAY OF
PACKAGED OR BOTTLED PRODUCTS ONLY





Private Picture Copyright : WWW.MBSM.PRO

GDM-06-LD BLK
8947049





Private Picture Copyright : WWW.MBSM.PRO



ture Copyright : WWW.MBSM.PRO





Private Picture Copyright : WWW.MBSM.PRO



Private Picture Copyright : WWW.MBSM.PRO



TRUE

True Manufacturing Co., Inc.
True Refrigeration
O'Fallon, MO 63366
MADE IN THE USA

CABINET
SERIAL
NUMBER:

7966464



7966464

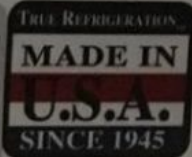

MODEL: **TUC-24**

DESIGN PRESSURES - PSI (N/cm²)

HIGH SIDE **312**

LOW SIDE **140**

REFRIG UNIT:
EM45HHR

CHARGE
REFRIGERANT: **R134A**

4 oz. (g)

HP	VOLTAGE	HZ	PH	F.L. AMPS
1/8	115	60	1	2.5

BBE

THIS UNIT LISTED UNDER N.S.F. NO. 7

U.S. PATENT NUMBERS:
5,553,354/5,433,082/5,699,676
D273,298/D271,107/5,584,547
6,792,769

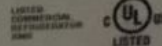

DO NOT CLEAN LABEL WITH SOLVENT
DRL

Intended for use in rooms
with an ambient temperature
of 86 (30C) or less



Private Picture Copyright : WWW.MBSM.PRO



Private Picture Copyright : WWW.MBSM.PRO

Approximate base metal temperature

Category: Technologie

written by www.mbsm.pro | 13 December 2021



Private Picture Copyright : WWW.MBSM.PRO

approximate base metal temperature

التمييز بين درجات حرارة المعدن خلال عملية التلحيم

#mbsmpro

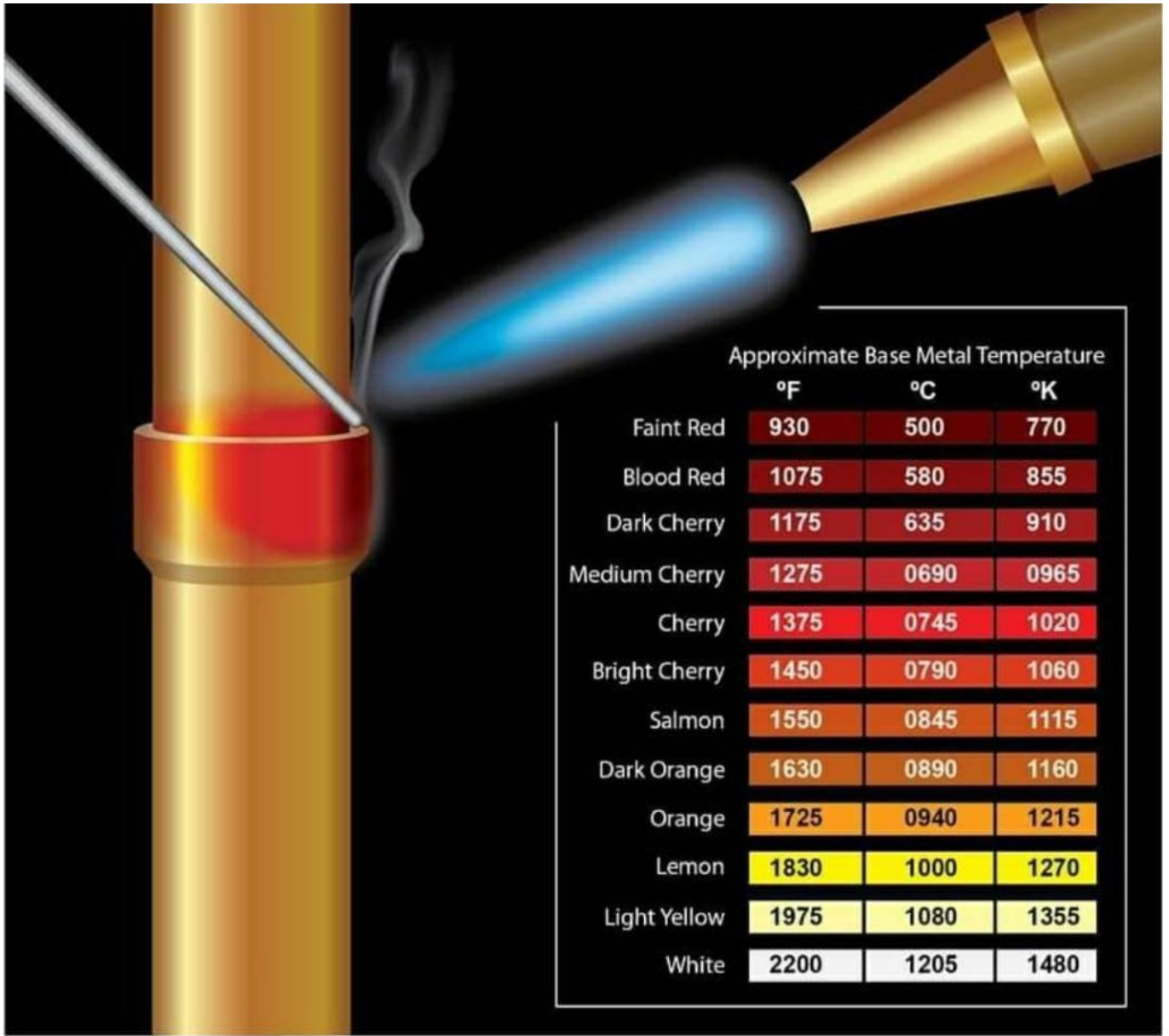

Private Picture Copyright: WWW.MBSM.PRO

Compressor, QD110, 3/10 HP, LBP, R12/R406, 276w, R12, R406

Category: compressor

written by www.mbsm.pro | 13 December 2021

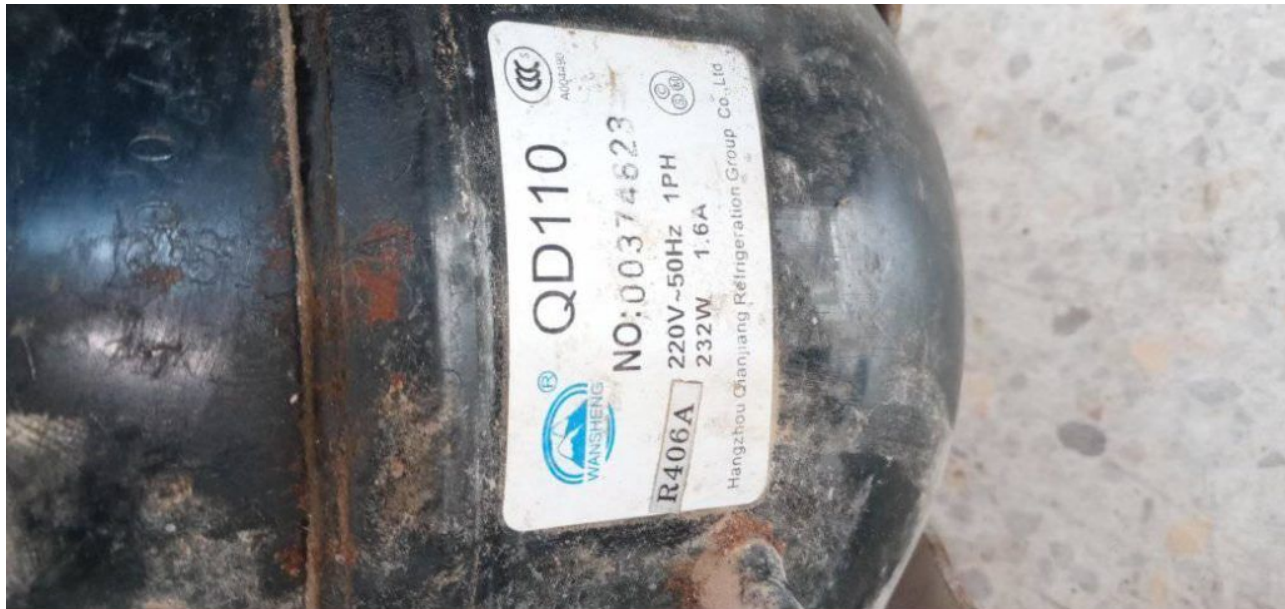

Private Picture Copyright: WWW.MBSM.PRO

Quantité(Pièce) 1 – 30 31 – 70 71 – 150 >150
 Durée estimée (jours) 5 10 15 À négocier
 Tension: 220 V-240 V
 50 HZ
 Compresseur LBP R12/R406

Modèle	Valage (V)	Fréquence (Hz)	Déplacement (CC)	Capacité (W)	Puissance d'entrée (W)	Type de moteur	De charge d'huile (CC)	Type de refroidissement	Poids (Kg)
QD30	220-240	50	3.0	62	81	RSIR	180	ST	6.3
QD36	220-240	50	3.6	75	93	RSIR	180	ST	6.4
QD55	220-240	50	5.5	133	110	RSIR	240	ST	8.4
QD65	220-240	50	6.5	155	130	RSIR	240	ST	8.4
QD75	220-240	50	7.5	176	146	RSIR	240	ST	8.6
QD85	220-240	50	8.5	202	168	RSIR	240	ST	8.9
QD110	220-240	50	11.0	276	236	RSIR	240	ST	9.9
QD125	220-240	50	12.5	305	254	RSCR	280	ST	11.2



Private Picture Copyright: WWW.MBSM.PRO

R406a 220~240V/50Hz

LBP
低背压

序号 No.	应用类型 Application	产品系列 Serial	产品型号 type	马力 Hp	电压/频率 Power Supply (V/Hz)	电机类型 Motor type	制冷量 Capacity		COP Power Efficiency		启动器 Starting Device	启动电容 Starting Capacitor (μF)	运行电容 Running Capacitor (μF)	冷却方式 Cool
							ASHRAE (-23.3°C)	CECOMAF (-25°C)	ASHRAE (-23.3°C)	CECOMAF (-25°C)				
							w		COP (w/w)					
1	LBP 低背压	WT	QD55	1/6	220~240V ~50Hz	RSIR	130	98	1.04	0.81	PTC	/	/	S
2			QD65	1/5		RSIR	158	119	1.08	0.84		/	/	S
3			QD75	1/4		RSIR	176	132	1.09	0.85		/	/	S
4			QD85	1/4		RSIR	202	152	1.10	0.86		/	/	S
5			QD91	1/4		RSIR	216	162	1.12	0.87		/	/	S
6	LBP 低背压	WQ	QD110	3/10	220~240V ~50Hz	RSIR	271	203	1.17	0.91	重锤 Starting Relay	/	/	F
7			QD128	1/3		RSIR	306	230	1.18	0.92		/	/	F
8			QD142	2/5		CSIR	333	250	1.19	0.93		80	/	F
9	LBP 低背压	SC	QD168	1/2	220~240V ~50Hz	CSIR	380	330	1.15	1.06	电流式 Current	80	/	F2
10			QD180	1/2		CSIR	440	382	1.15	1.07		80	/	F2
11			QD210	3/5		CSIR	510	443	1.17	1.08		80	/	F2



Private Picture Copyright: WWW.MBSM.PRO

Tecumseh, Compressor, 5/8HP, HMBP – R404A , R448A , R449A, MBP, CAJ9480Z, 230V

Category: compressor

written by www.mbsm.pro | 13 December 2021



Private Picture Copyright: WWW.MBSM.PRO

Caractéristiques techniques

- Marque : TECUMSEH UNITÉ HERMÉTIQUE
- Modèle : CAJ9480Z-R
- CYLINDRÉE (CM³)15,2
- FLUIDER404A , R448A , R449A
- APPLICATIONHMBP
- PLAGÉ D'APPLICATION-25/+15
- PUISSANCE (W)1159
- PUISSANCE FRIGORIFIQUE (TK+40°C)15/3350 5/2355 -10/1294 -25/609
- TENSION (V)240/1/50
- DÉMARRAGECSR
- I.MAX (A)6,7
- Ø ASPIRATION1/2
- Ø REFOULEMENT5/16
- DIMENSIONS (MM)235x178x280
- Gaz: **R-404a**
- Température/Pression: **Haute Pression**
- Puissance: **5/8 HP**
- Voltage: **230 V**
- Type De Courant: **Monophasé**
- Fréquence: **50 Hz**
- Type De Compresseur: **Hermétique**
- Décalage: **15.2 cm³**
- Cons.Énergie -25°C: **496 W**
- Cons.Énergie -10°C: **669 W**
- Cons.Énergie -5°C: **718 W**
- Cons.Énergie 0°C: **762 W**
- Cons.Énergie +5°C: **798 W**
- Cons.Énergie +10°C: **828 W**
- T° De Condensation: **40 °C**
- Capacité Frigorífica -25°C: **524 Kcal/h**
- Capacité Frigorífica -20°C: **692 Kcal/h**
- Capacité Frigorífica -15°C: **887 Kcal/h**
- Capacité Frigorífica -10°C: **1113 Kcal/h**
- Capacité Frigorífica -5°C: **1374 Kcal/h**
- Capacité Frigorífica 0°C: **1677 Kcal/h**
- Capacité Frigorífica 5°C: **2025 Kcal/h**
- Capacité Frigorífica 10°C: **2425 Kcal/h**
- Tipo Test: **EN.12900**

Compresseur L'unité Hermetique – Tecumseh CAJ9480Z – R404A, R449A, R407A, R452A
220 – 240V 1~ 50 Hz

Cylindrée = 15.2 CM³

APPLICATIONS = HBP / MHBP

Moteur type: CSR



Private Picture Copyright : WWW.MBSM.PRO



Private Picture Copyright : WWW.MBSM.PRO



Private Picture Copyright : WWW.MBSM.PRO



Private Picture Copyright : WWW.MBSM.PRO



Private Picture Copyright : WWW.MBSM.PRO





● ○ REDMI NOTE 9 PRO
∞ AI QUAD CAMERA

Private Picture Copyright : WWW.MBSM.PRO





● ○ REDMI NOTE 9 PRO
∞ AI QUAD CAMERA

Private Picture Copyright : WWW.MBSM.PRO

Mbsm_dot_pro_private_PDF_caj9480Z_2494-specetélécharger

Compresseur AJ = Le produit de référence associant silence, fiabilité et

efficacité du froid commercial.

Product Code	Model Number	Compressor Horsepower	Compressor Displacement	Cooling Oil Charge
	CAJ9480Z-FZ	5/8 HP	15.2 cm ³ /rev	Fan 475 ml
	CAJ9510Z-FZ	1 HP	18.3 cm ³ /rev	Fan 475 ml
	CAJ9513Z-FZ	1 1/8 HP	24.2 cm ³ /rev	Fan 475 ml
	CAJ4517Z-FZ	1.25 HP	25.95 cm ³ /rev	Fan 475 ml
	TAJ4517Z-TZ	1.25 HP	25.95 cm ³ /rev	Fan 475 ml
	CAJ4519Z-FZ	1.5 HP	34.45 cm ³ /rev	Fan 475 ml
	TAJ4519Z-TZ	1.5 HP	34.45 cm ³ /rev	Fan 475 ml