

Tecumseh, Compressor, TPA1410YXC, TPA1410 YXC, LBP, R134a, 220-240V ~ 50Hz, 1/4 + HP, 115V

Category: compressor

written by www.mbsm.pro | 25 January 2021



Private Picture Copyright: WWW.MBSM.PRO

Mbsm.pro, refrigerator, TPA1410YXC, KIRIAZI, no frost, 635 L, r134a, 180 g, Compressor, TPA1410YXC, 1/4 hp++

Fabricant: Tecumseh

R134a Compressor

Low Temperature

Compresseurs haute température R134a chargés d'huile ester et ont une plage d'évaporateur de 20 ° F à 55

° F R134a compresseurs de température commerciale chargés d'huile ester et ont une plage d'évaporateur de 0 ° F à 50 ° F

Compresseurs basse température R134a chargés d'huile ester et ayant une plage d'évaporateur de -40 ° F à + 10

° F Tous les composants de départ sont inclus si nécessaire

Tout le matériel de montage inclus

Capacité nominale en BtuH basée sur une température de condensation de 130 ° F

Spécifications

Aspiration Conn: 5/16 "IDS

Discharge Conn: 1/4" IDS

HP: 1/4 +

Volts: 115

Phases: 1

BtuH Capacité à 20 ° F Evap: 1100

Remplace la référence: TPA1410YXA, B81-983

Spécifications du produit

Performance

État	Tension d'essai	(R) Btu / h	(R) kcal / h	(R) W	(I) W	(E) Btu / Wh	(E) kcal / Wh	W / W	TEMP ÉVAP	COND TEMP	TEMPÉRATURE AMBIANTE	RETOUR GAZ	TEMP. LIQUIDE
ASHRAE (R-513A)	220V ~ 50HZ	977	246	286	186	5,24	1,32	1,54	-23 ° C (-10 ° F)	54 ° C (130 ° F)	32 ° C (90 ° F)	32 ° C (90 ° F)	32 ° C (90 ° F)
ASHRAE (R-134a)	220V ~ 50HZ	920	232	270	176	5,23	1,32	1,53	-23 ° C (-10 ° F)	54 ° C (130 ° F)	32 ° C (90 ° F)	32 ° C (90 ° F)	32 ° C (90 ° F)

Général

Température d'évaporation. Gamme : -34,4 ° C à -12,2 ° C (-30 ° F à 10 ° F)

Couple moteur : Couple de démarrage faible (LST)

Refroidissement du compresseur : Ventilateur

Mécanique

Poids : 30
Unité de mesure de poids : KG
Déplacement (cc) : 8,374
Type d'huile : Polyolester
Viscosité (cSt) : 32
Charge d'huile (cc) : 185

Électrique

Gamme de tension (50 Hz) : 198-264
Gamme de tension (60 Hz) : N / A
Ampères à rotor bloqué (LRA) : 17
Intensité de charge nominale (RLA 50 Hz) : 0,82
Intensité de charge nominale (RLA 60 Hz) : 0
Max. Courant continu (MCC en ampères) : 0
Résistance du moteur (Ohm) – Principal : 10,19
Résistance du moteur (Ohm) – Démarrage : 6,07
Type de moteur : PTCS_CR
Type de surcharge : N / A
Type de relais : N / A
Répertorié IRAM, reconnu cURus



Private Picture Copyright : WWW.MBSM.PRO



Picture Copyright : WWW.MBSM.PRO



Picture Copyright : WWW.MBSM.PRO

[Mbsm_dot_pro_private_PDF_TPA1410YXCTélécharger](#)

[Mbsm_dot_pro_private_PDF_TPA1410YXC-Tecumseh-do-BrazilTélécharger](#)

Mbsm.pro, PDF, DAEWOO COMPRESSOR, HPL23YH-5, 199W, 1/4 Hp, R134A , 90G

Category: Files

written by www.mbsm.pro | 25 January 2021



Private Picture Copyright : WWW.MBSM.PRO



Private Picture Copyright: WWW.MBSM.PRO

[Mbsm_dot_pro_private_PDF_HPL23YH-5Télécharger](#)

[Mbsm_dot_pro_private_PDF_HPL23YH-5-2Télécharger](#)





Private Picture Copyright: WWW.MBSM.PRO

DAEWOO COMPRESSOR, HPL23YH-5, 199W,
1/4 Hp, R134A , 90G, CONGELATEUR, No-
Frost, ENIM, ALGERIE, REFREGERATEUR,
FR 4506, FR 4506 K, FR-4506K, Classe
N, Volume Brut 447L , Volume utile
273L, Volume congélat 101L , 220-240v
50Hz

Category: compressor

written by www.mbsm.pro | 25 January 2021

1. OUTLINE

DIVISION		CONTENTS
MODEL NAME		FR4506K/N
USABLE CAPACITY(l)	FREEZER	101
	REFRIGERATOR	273
	TOTAL	374
EXTERNAL DIMENSION	WIDTH	708mm
	DEPTH	706mm
	HEIGHT	1715/1759mm
REFRIGERANT	R134a	90g
COOLING & CONTROL SYSTEM	COOLING SYSTEM	Fan Cooling System
	DEFROST SYSTEM	Fin Evaporator Forced
	DEFROST CONTROL	Automatic Start & Stop
NET WEIGHT(Kg)		69kg

Private Picture Copyright: WWW.MBSM.PRO

Capacité totale 374 L

Compartiment denrées fraîches 273L

Compartiment denrées congelées 101L

Dimensions (mm) – Sans emballage : 1759X706X708mm

– Avec emballage : 1801X726X754mm Poids

net (kg) : 78Kg

Brut (kg) : 69Kg

Contrôle des températures Thermostat

Type de refroidissement : No Frost (Dynamique)

Éclairage intérieur

Alimentation : 220-230/50/HZ

Consommation d'énergie (kwh / an) 520

Classe énergétique B

Classe climatique : Tempérée T

CFC 0 %

Réfrigérant R134 A



ENIEM		Fabriqué en Algérie
Réfrigérateur-Congélateur	****	
Modèle FR-4506K		Classe N
Volume brut		447L
Volume utile compt denrées fraîches		273L
Volume utile compt basse température		101L
Voltage / Fréquence		220-240V - 50Hz
Puissance		
Puissance de dégivrage		160W
Puissance de lampe		15W*1
Consommation d'énergie(kwh/24h)		1.42
Réfrigérant R134a		90 grs
N° de série		
Code : Q376-29-1		





Picture Copyright : WWW.MBSM.PRO

ENIEM		Fabriqué en Algérie
Réfrigérateur-Congélateur	****	
Modèle FR-4506K		Classe N
Volume brut	447L	
Volume utile compt denrées fraîches	273L	
Volume utile compt basse température	101L	
Voltage / Fréquence	220-240V -- 50Hz	
Puissance		
Puissance de dégivrage	160W	
Puissance de lampe	15W*1	
Consommation d'énergie(kwh/24h)	1.42	
Réfrigérant R134a	90 grs	
N° de série		
Code : Q376-29.1		



Private Picture Copyright : WWW.MBSM.PRO

1. OUTLINE

DIVISION		CONTENTS
MODEL NAME		FR4506K/N
USABLE CAPACITY(l)	FREEZER	101
	REFRIGERATOR	273
	TOTAL	374
EXTERNAL DIMENSION	WIDTH	708mm
	DEPTH	706mm
	HEIGHT	1715/1759mm
REFRIGERANT	R134a	90g
COOLING & CONTROL SYSTEM	COOLING SYSTEM	Fan Cooling System
	DEFROST SYSTEM	Fin Evaporator Forced
	DEFROST CONTROL	Automatic Start & Stop
NET WEIGHT(Kg)		69kg

Private Picture Copyright : WWW.MBSM.PRO



HEL23YG-3B
② ② ② ② ② ②

NO	CONTENTS	
① Refrigerant	H : R134a I : R600a No marking : R12	
② Motor type	PTC	100V Series F : RSIR E : RSCR C : CSIR B : CSR 220V Series S : RSIR P : RSCR K : CSIR D : CSR
	C-relay	100V Series R : RSIR N : CSIR 220V Series T : RSIR G : CSIR
③ Application	L : L B P H : H B P	
④ Grade of Cooling Capacity	(reference : table of capacity range)	
⑤ Series name	JE Y YE YH YG	
⑥ Voltage & Frequency	No marking : 100V 50/60Hz	
	1 : 110-115V 60Hz	5 : 220-240V 50Hz
	2 : 127V 60Hz	7 : 115-127V 60Hz
	3 : 110V 60Hz	8 : 220-240V 50Hz / 220V 60Hz
	4 : 220V 60Hz	9 : 110V 50Hz
⑦ Improvedata order		

Private Picture Copyright : WWW.MBSM.PRO

Model	Cooling Capacity			Efficiency			Motor Type	Cooling Type	NetWeight [kg]	OilQty. [cc]
	Kcal/h	Watt	Btu/h	EFF Kcal/Wh	COP W/W	EER Btu/Wh				
HPL21YE-5-K	155	180	615	1.00	1.16	3.97	RSCR	ST/OC/FC	9	290
HPL21YE-5-L	155	180	615	1.04	1.2	4.11	RSCR	ST/OC/FC	8.9	290
HSL21YE-5	155	180	615	1.04	1.21	4.13	RSIR	ST/OC/FC	9	290
HPL23YE-5	171	199	635	1.1	1.27	4.35	RSCR	ST/OC/FC	9.5	290
HPL23YE-5-K	171	199	679	1.14	1.19	4.52	RSCR	ST/OC/FC	9	290
HSL23YE-5	171	199	679	1.06	1.16	4.21	RSIR	ST/OC/FC	9.3	290
HGH23YE-5	581	676	2306	1.94	2.25	7.69	CSIR	OC/FC	9.3	290
HKL25YE-5	180	209	714	0.97	1.19	3.84	CSIR	ST/OC/FC	9.5	290
HPL25YE-5-K	180	209	714	1.22	1.29	4.86	RSCR	ST/OC/FC	9	290
HPL25YE-5-L	180	209	714	1.07	1.31	4.23	RSCR	ST/OC/FC	9	290
HGH25YE-5	631	734	2504	1.88	2.19	7.47	CSIR	OC/FC	9.5	290
HKL27YE-5	210	244	833	1.01	1.17	4.27	CSIR	ST/OC/FC	9.5	290
HPL27YE-5	210	244	833	1.01	1.31	4.63	RSCR	ST/OC/FC	9.5	290
HPL27YE-5-K	210	244	833	1.01	1.2	4.90	RSCR	ST/OC/FC	9	290
HSL27YE-5	210	244	833	1.01	1.2	4.32	RSIR	ST/OC/FC	9.5	290
HSL27YE-5A	210	244	833	1.01	1.22	4.32	RSIR	ST/OC/FC	9.5	290
HKH27YE-5	732	851	2817	1.92	2.23	7.61	CSIR	OC/FC	9.5	290
HSH27YE-5	732	851	2817	1.88	2.19	7.47	RSIR	OC/FC	9.5	290
HKL30YE-5	230	267	913	1.01	1.1	3.61	CSIR	ST/OC/FC	9.5	290
HPL30YE-5-K	230	267	913	1.01	1.28	4.75	RSCR	ST/OC/FC	9	290
HSL30YE-5	230	267	913	1.01	1.05	3.61	RSIR	ST/OC/FC	9.5	290
HSH30YE-5	780	907	3095	1.01	2.13	6.57	RSIR	OC/FC	9.5	290
HKL30YE-5	230	267	913	1.01	1.1	3.61	CSIR	ST/OC/FC	9.5	290
HPL30YE-5-K	230	267	913	1.01	1.28	4.41	RSCR	ST/OC/FC	9	290
HSL30YE-5	230	267	913	1.01	1.05	3.61	RSIR	ST/OC/FC	9.5	290

Private Picture Copyright : WWW.MBSM.PRO

2. ELECTRIC PARTS

1) COMPRESSOR

REFRIGERANT	R-12						
VOLTAGE(V/Hz)	110/60	115,120/60	127/60	220/60	220/50	230/50	240/50
COMP MODEL	X	X	CL23YE-2	PL21YE-4	SL27YE-5		
PART CODE	X	X	3957123A20	3956121A40	3954127A50		
STARTING TYPE	X	X	CSIR	RSCR	RSIR		

REFRIGERANT	R-134a						
VOLTAGE(V/Hz)	110/60	115,120/60	127/60	220/60	220/50	230/50	240/50
COMP MODEL	HEL18YH-1	<	HEL21YH-1	X	HPL23YH-5	<	<
PART CODE	3953118S10	<	3953121S10	X	3956123S50	<	<
STARTING TYPE	RSCR	<	RSCR	X	RSCR	<	<

2) RELAY

REFRIGERANT		R-12						
VOLTAGE(V/Hz)		110/60	115,120/60	127/60	220/60	220/50	230/50	240/50
ASSY	TYPE NAME	X	X	414THBYY-52	197SHBYY-52	232THBYY-52	<	<
	PART CODE	X	X	3018120700	3018118130	3018119970	<	<
PTC	RESISTANCE	X	X	S068	S330	S220	<	<
OVER LOAD	PART NAME	X	X	414THB	197SHB	232THB	<	<

Private Picture Copyright: WWW.MBSM.PRO



Private Picture Copyright: WWW.MBSM.PRO

Mbsm_dot_pro_private_PDF_HPL23YH-5Télécharger
Mbsm_dot_pro_private_PDF_HPL23YH-5-Télécharger
Mbsm_dot_pro_private_PDF_HPL23YH-5-2Télécharger
Mbsm_dot_pro_private_PDF_HPL23YH-5-3Télécharger

Mbsm.pro, PDF, Compressor, ZMC, 1/4
HP, LBP, RSIR / RSCR, GM 80 AF,
GM80AF, R-134

Category: Files

written by www.mbsm.pro | 25 January 2021

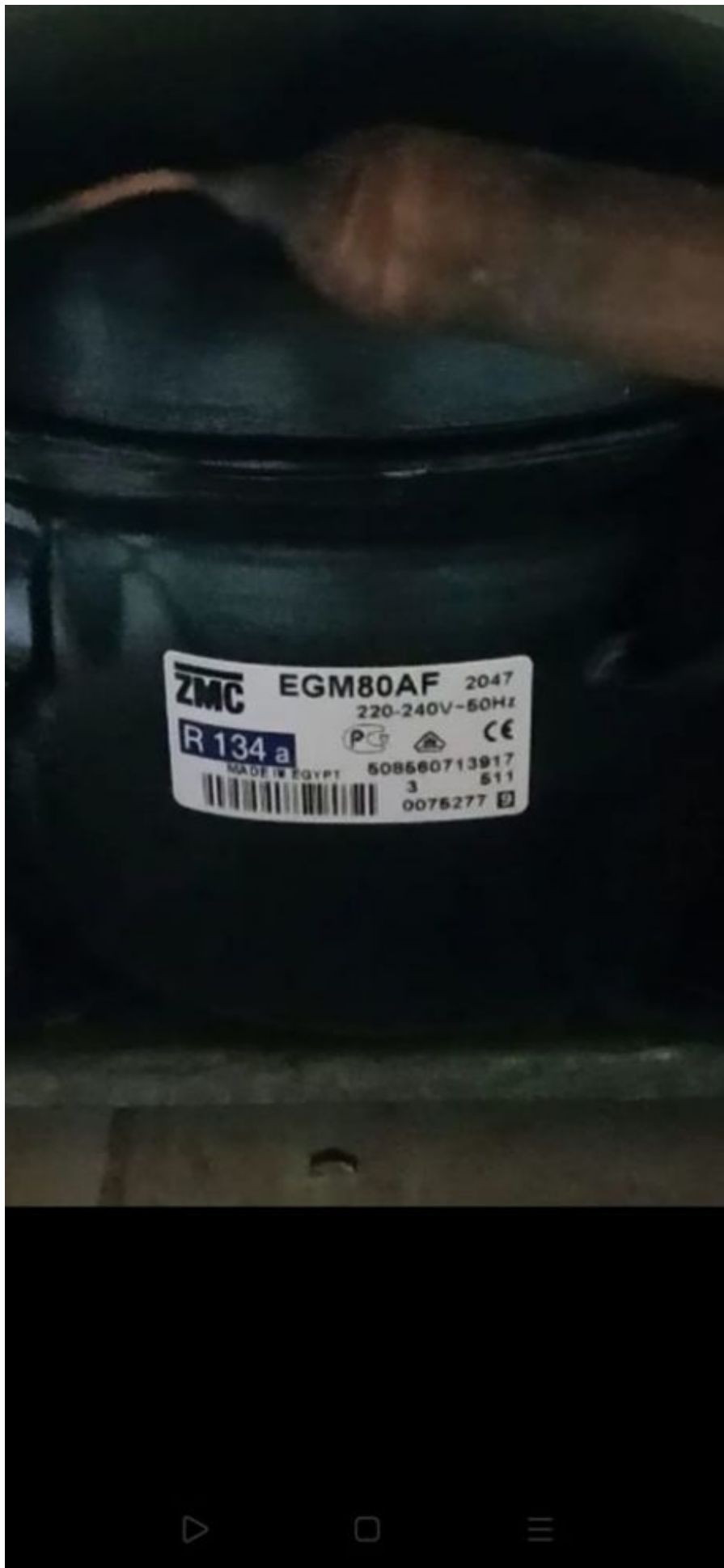

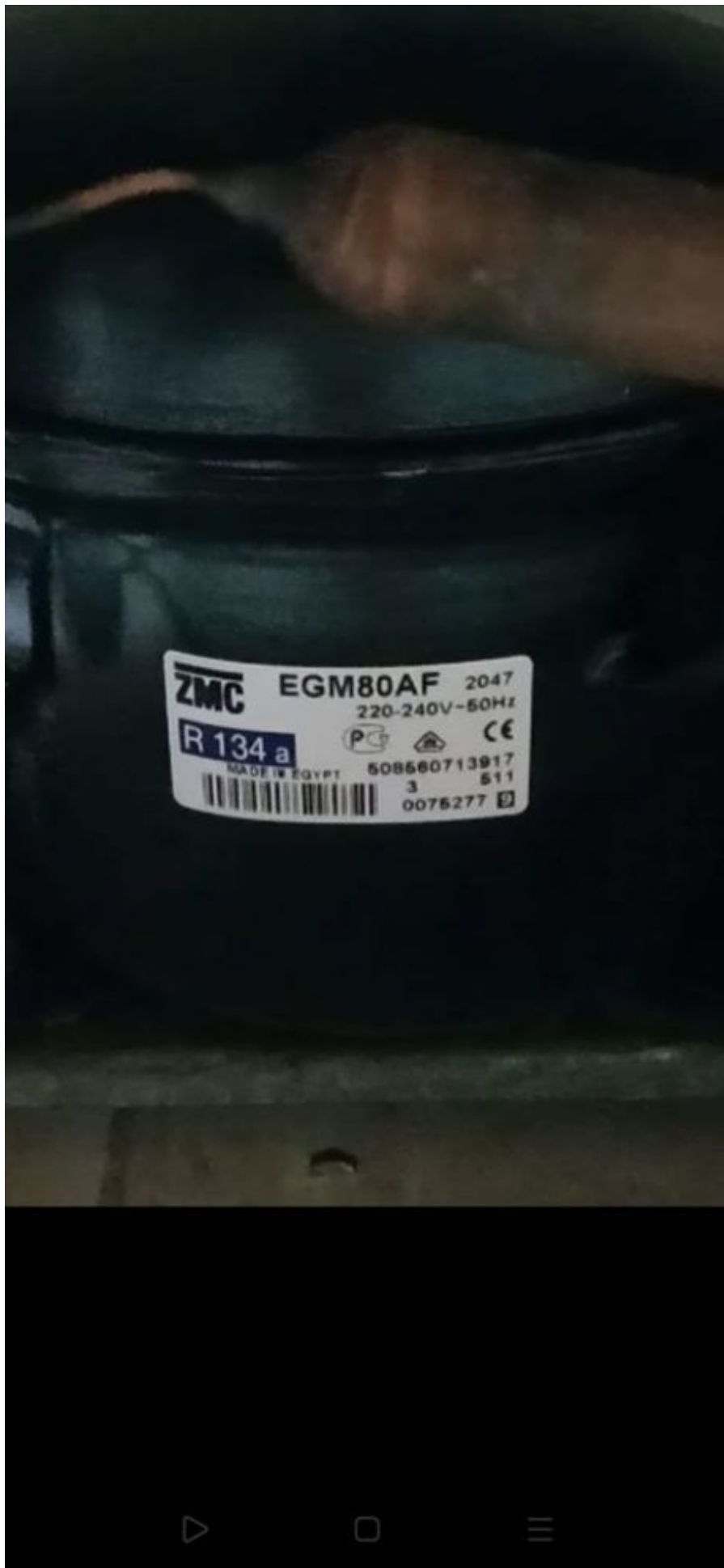

Compressor, Frigo, Moteur ZMC, 1/4
HP, LBP, RSIR / RSCR, GM 80 AF,
GM80AF, R-134, 198 KCAL, Frigo OCEAN,
100cm/60cm , Ocean, Made in Egipt,
Capacity 295 L, Charge 100G

Category: compressor

written by www.mbsm.pro | 25 January 2021

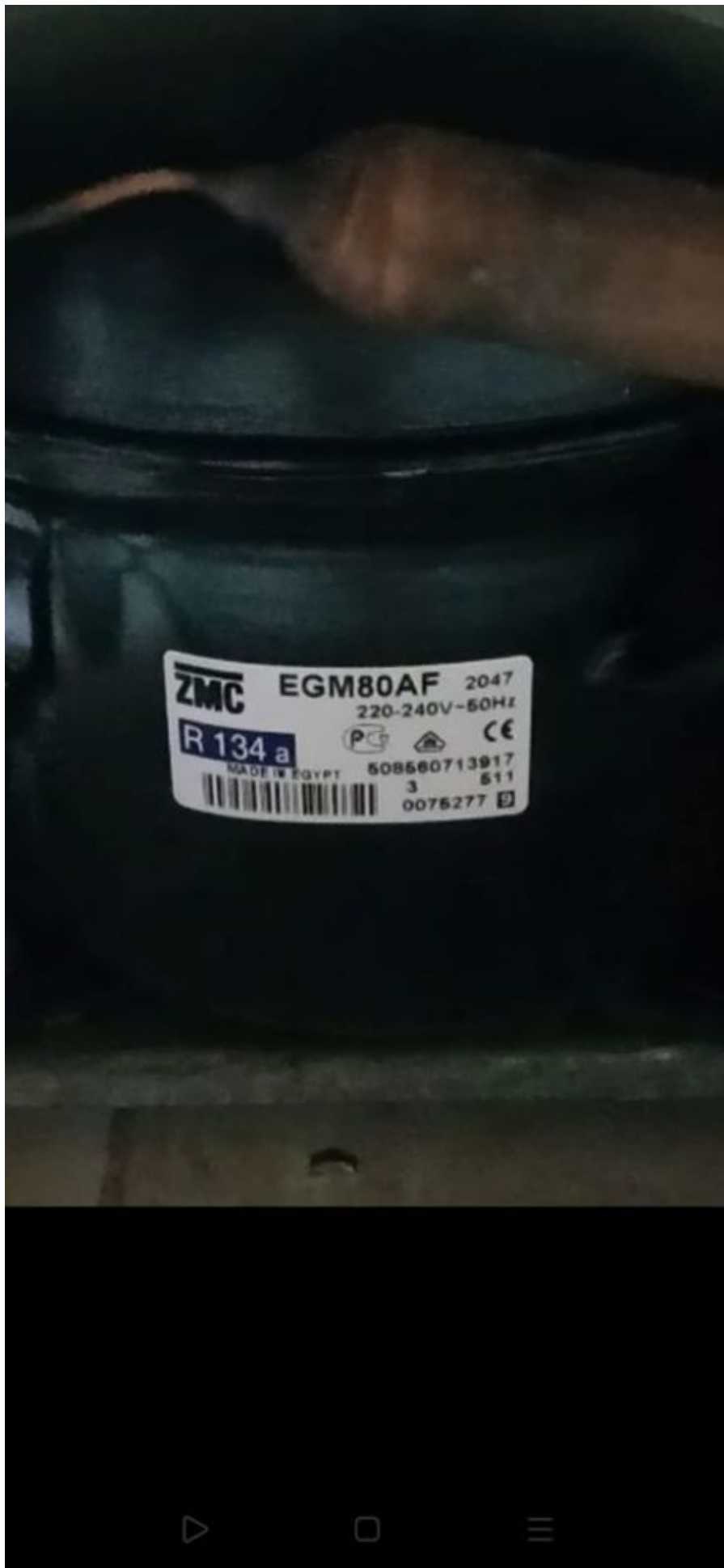

ABOUT ZMC

WE ARE MISR COMPRESSOR MANUFACTURING CO. (MCMC) A COMPANY ESTABLISHED IN 1988, DEDICATED TO MANUFACTURING OF HERMETIC COMPRESSORS FOR HOUSEHOLD AND COMMERCIAL REFRIGERATION INDUSTRY

MODÈLE: EGM80AF CODE: 508500314016

Données GENERALES

Réfrigérant:	R134a
Application:	LBP
Plage de température d'évaporation:	-30 ° C à -10 ° C
Tension / Fréquence:	220 / 240V / 50 HZ
Refroidissement du compresseur:	Statique
Périphérique d'extension:	Tube capillaire
Quantité d'emballage:	Multi – 96: 120 pièces
Approbations:	CE-VDE-GOST

Données mécaniques

Charge d'huile:	350 cm ³
Configuration du type d'huile:	ester
Viscosité du type d'huile:	19 cSt
Poids:	9,5 kg

Données électriques

Type de moteur:	RSIR / RSCR *
Plage de travail de tension à 50 Hz:	187-264V
Température maximale du moteur:	130 ° C
Courant de rotor bloqué:	14,43 / 8,50 A
Début de la résistance d'enroulement:	15,80 Ω à 25 ° C
Résistance d'enroulement de course:	10,40 Ω à 25 ° C
Phase:	1 ph

Caractéristiques externes

Diamètre intérieur	(mm)
Connecteur d'aspiration	6,5
Connecteur de décharge	4,9
Connecteur de processus	6,5
Matériel	Cuivre

Composants électriques

Dispositif de démarrage:	PTC 14Ω
Protection du moteur:	T0490 / xx

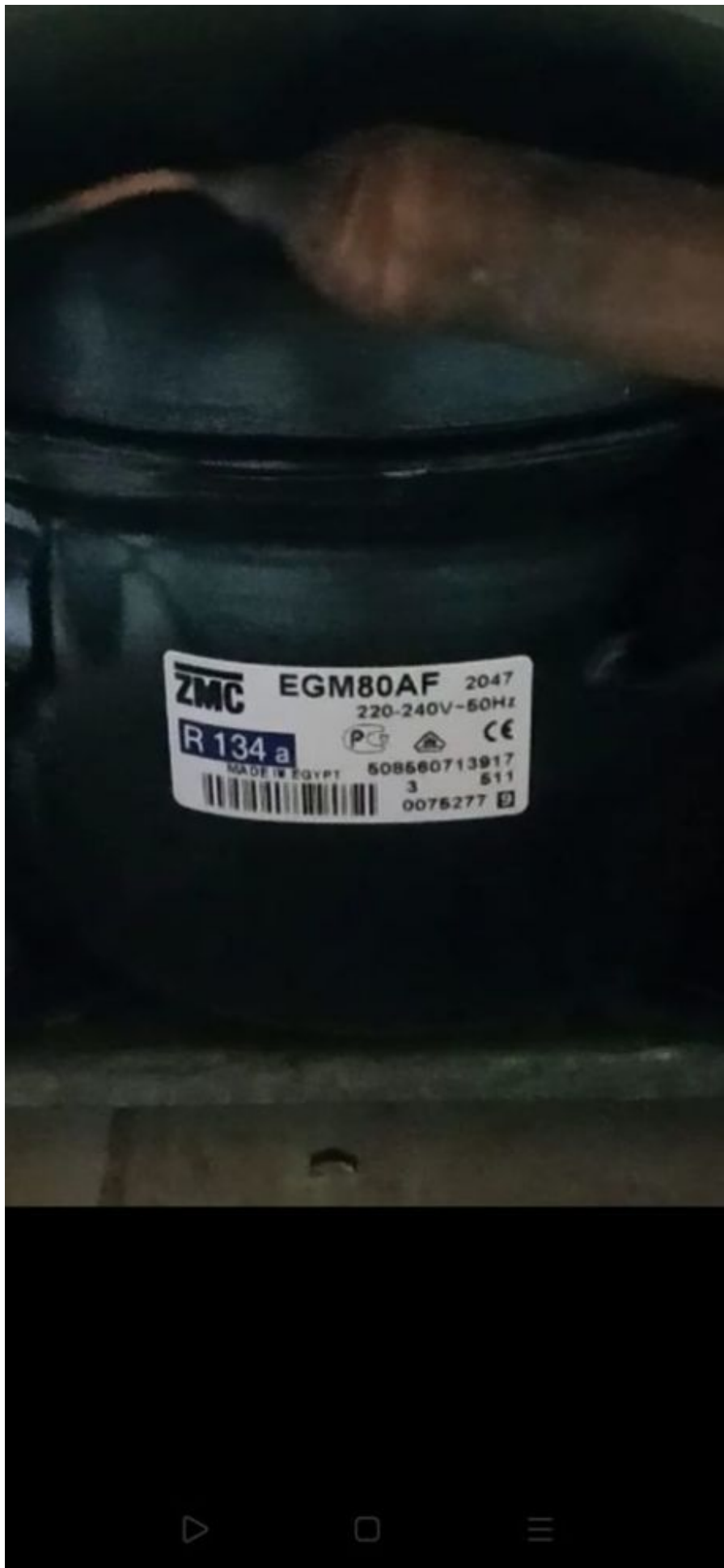

Ocean

Egyptian Italian Appliances



OCDF29514001035

Product Name. DF295 Silver	Code. DFOC295LSL004	Refrigerant R134A - 0.1 Kg
Voltage. 220-230 V	Motor Input. 1.7 A	50 / 60 Hz
Lamp Power. 15 W	Capacity. 295 L	Class. T
Net Wt. 44 Kg	Gross Wt. 49 Kg	Made in Egypt

Ocean

Egyptian Italian for Electrical Appliances



OCDF29514001035

Product Name. DF295 Silver	Code. DFOC295LSL004	Refrigerant R134A - 2.1 Kg
Voltage. 220-230 V	Motor Input. 1.7 A	50 / 60 Hz
Leak Power. 15 W	Capacity. 295 L	Class. T
Net Wt. 44 Kg	Gross Wt. 49 Kg	Made in Egypt





متر في 60

Private Picture Copyright : WWW.MBSM.PRO

Mbsm_dot_pro_private_PDF_EGM80AFTélécharger

Compressor, ASPERA, b3118b , 1/4 hp ,
240V~50hZ, Frigidaire 2 portes,
Philips, 180W, Class T, 422L (460L
Total), compressor b3118b, 220g ,
R134a

Category: compressor,Non classé
written by www.mbsm.pro | 25 January 2021



PHILIPS

MADE IN EGYPT

Service
Service
Service
230 V
50 Hz
180 W

MODEL ARG 425 / PH

Class T

Gross Volume	460	Ltr
Net Volume	440	Ltr
Net Storing Volume	422.5	Ltr
System Compressor	ccl ₂ F2 220 g	

1000000000

Compressor, ASPERA, b3118b , 1/4 hp , 240V~50hZ, Frigidaire 2 portes, Philips,
180W, Class T, 422L (460L Total), compressor b3118b, 220g , R134a



PHILIPS

MADE IN EGYPT

Service
Service
Service

MODEL ARG 425 / PH

230 V - 50 Hz

Class T

Gross Volume	460	Ltr
Net Volume	440	Ltr
Net Storing Volume	422.5	Ltr
System Compressor	ccl ₂ F ₂ 220 g	

1000000000

4.30 BAJA TEMPERATURA, Monofásicos 220 V 50 Hz

R12
MP39
FX56

Modelo	Tipo	CV.	Cm3	Código	Precio €
BP1084A	S	1/8	4,30	10600	-
BP1111A	S	1/8	5,73	10601	139,00
NB1112A	S	1/6	5,9	10602	167,00
NB1116A	S	1/4	8	10603	161,00
B3116B	RH	1/4	8	10604	166,00
NB1118A	S	1/4	8,85	10605	165,00
B3118B	RH	1/4	8,85	10606	172,00
B2118B	S	1/4	8,85	10607	181,00

Modelo	Tipo	CV.	Cm3	Código	Precio €
NE2121A	F	1/3	12,00	10608	210,00
T2124A	F	1/3	12,58	10609	-
T2128A	F	1/3	14,50	10610	-
NE2130A	F	1/3	14,20	10611	236,00
T2134A	F	3/8	17,40	10612	310,00
T2140A	F	3/8	20,40	10613	321,00
J2152A	F	1/2	26,00	10614	439,00
J2170A	F	3/4	34,37	10615	462,00

Ver aplicación de todos los compresores de esta página en el nuevo reglamento Europeo (CE) nº 2037/2000, publicado el 29/09/2000.

4.40 BAJA TEMPERATURA, Monofásicos 220 V 50 Hz

R22
R417a
R427a

Modelo	Tipo	CV.	Cm3	Código	Precio €
NE2125E	F	1/3	8,90	10618	199,00
NE2134E	F	3/8	12,00	10619	217,00
T2140E	F	1/2	14,50	10620	339,00
T2155E	F	5/8	17,40	10621	362,00

Modelo	Tipo	CV.	Cm3	Código	Precio €
T2168E	F	3/4	20,40	10622	373,00
NJ2178E	F	3/4	23,50	10623	413,00
J2190E	F	3/4	27,10	10624	429,00







Private Picture Copyright: WWW.MBSM.PRO



Tecumseh, competitive, cross, RG211-12, RG211, 1/4 hp , 1150 BTU, R134a, 1.29 FLA, 12.0 LRA, 220v-240v0/60hz

Category: compressor

written by www.mbsm.pro | 25 January 2021



Competitive Cross Referenc

Americold BW & Hupp	App-Ref	Volt/Hz/Ph	Btu/h	Tecumseh Model
LT-R134a (continued)				
GP16FE	LT-R134a	115/60/1	1440	AEA2413YXA
GRG105-1	LT-R134a	115/60/1	580	AEA1360YXA
GRG106-1	LT-R134a	115/60/1	670	AEA1360YXA
GRG107-1	LT-R134a	115/60/1	740	TPA1380YXA
GRG108-1	LT-R134a	115/60/1	840	TPA1380YXA
GRG109-1	LT-R134a	115/60/1	970	TPA1390YXA
GRG205-1	LT-R134a	115/60/1	580	AEA1360YXA, OIL COOLER
GRG206-1	LT-R134a	115/60/1	670	AEA1360YXA
GRG207-1	LT-R134a	115/60/1	740	TPA1380YXA
GRG208-1	LT-R134a	115/60/1	840	TPA1380YXA
GRG209-1	LT-R134a	115/60/1	970	TPA1390YXA
GRH104-1	LT-R134a	115/60/1	475	N/A
GRH105-1	LT-R134a	115/60/1	590	AEA1360YXA
GRH106-1	LT-R134a	115/60/1	675	AEA1360YXA
GRH107-1	LT-R134a	115/60/1	770	TPA1380YXA
GRH108-1	LT-R134a	115/60/1	880	TPA1380YXA
GRH109-1	LT-R134a	115/60/1	990	TPA1390YXA
GRH110-1	LT-R134a	115/60/1	1050	AEA2410YXA, TP1410YXA
RF107-1	LT-R134a	115/60/1	740	TPA1380YXA
RF108-1	LT-R134a	115/60/1	858	TPA1380YXA
RG107-1	LT-R134a	115/60/1	730	TPA1380YXA
RG108-1	LT-R134a	115/60/1	845	TPA1380YXA
RG109-1	LT-R134a	115/60/1	910	TPA1390YXA
RG111-1	LT-R134a	115/60/1	1150	AEA2410YXA, TPA1410YXA
RG113-1	LT-R134a	115/60/1	1300	AEA2413YXA
RG211-1	LT-R134a	115/60/1	1150	AEA2410YXA, TPA1410YXA
RG213-1	LT-R134a	115/60/1	1325	AEA2413YXA
RH106-1	LT-R134a	115/60/1	674	AEA1360YXA



Private Picture Copyright : WWW.MBSM.PRO

Mbsm_dot_pro_private_PDF_tecumseh_competitive_cross_refTélécharger

Tecumseh, competitive, cross, RG211-12, 1/4 hp , 1150 BTU, R134a, 1.29 FLA, 12.0 LRA, 220v-240v0/60hz

Americold BW & Hupp App-Ref Volt/Hz/Ph Btu/h Tecumseh Model

LT-R134a (continued)

GP16FE LT-R134a 115/60/1 1440 AEA2413YXA
GRG105-1 LT-R134a 115/60/1 580 AEA1360YXA
GRG106-1 LT-R134a 115/60/1 670 AEA1360YXA
GRG107-1 LT-R134a 115/60/1 740 TPA1380YXA
GRG108-1 LT-R134a 115/60/1 840 TPA1380YXA
GRG109-1 LT-R134a 115/60/1 970 TPA1390YXA
GRG205-1 LT-R134a 115/60/1 580 AEA1360YXA, OIL COOLER
GRG206-1 LT-R134a 115/60/1 670 AEA1360YXA

GRG207-1 LT-R134a 115/60/1 740 TPA1380YXA
GRG208-1 LT-R134a 115/60/1 840 TPA1380YXA
GRG209-1 LT-R134a 115/60/1 970 TPA1390YXA
GRH104-1 LT-R134a 115/60/1 475 N/A
GRH105-1 LT-R134a 115/60/1 590 AEA1360YXA
GRH106-1 LT-R134a 115/60/1 675 AEA1360YXA
GRH107-1 LT-R134a 115/60/1 770 TPA1380YXA
GRH108-1 LT-R134a 115/60/1 880 TPA1380YXA
GRH109-1 LT-R134a 115/60/1 990 TPA1390YXA
GRH110-1 LT-R134a 115/60/1 1050 AEA2410YXA, TP1410YXA
RF107-1 LT-R134a 115/60/1 740 TPA1380YXA
RF108-1 LT-R134a 115/60/1 858 TPA1380YXA
RG107-1 LT-R134a 115/60/1 730 TPA1380YXA
RG108-1 LT-R134a 115/60/1 845 TPA1380YXA
RG109-1 LT-R134a 115/60/1 910 TPA1390YXA
RG111-1 LT-R134a 115/60/1 1150 AEA2410YXA, TPA1410YXA
RG113-1 LT-R134a 115/60/1 1300 AEA2413YXA
RG211-1 LT-R134a 115/60/1 1150 AEA2410YXA, TPA1410YXA
RG213-1 LT-R134a 115/60/1 1325 AEA2413YXA
RH106-1 LT-R134a 115/60/1 674 AEA1360YXA
RH107-1 LT-R134a 115/60/1 730 TPA1380YXA
RH108-1 LT-R134a 115/60/1 840 TPA1380YXA
RH109-1 LT-R134a 115/60/1 980 AEA2410YXA, TPA1410YXA
RH110-1 LT-R134a 115/60/1 990 AEA2410YXA, TPA1410YXA
LT-R22
CL25A LT-R22 115/60/1 1210 AEA1411EXA
CL33A LT-R22 115/60/1 1520 N/A
L50A LT-R22 115/60/1;
208-230/60/1 SPECIAL N/A
OSG107-1 LT-R22 115/60/1 766 AEA0415EXA
OSG207-1 LT-R22 115/60/1 766 AEA0415EXA, OIL COOLER
OSG212-1 LT-R22 115/60/1 1254 AKA9428EXA
LT-R404A
HP310-1 LT-R404A 115/60/1 1080 AEA2410ZXA
HP317-1 LT-R404A 115/60/1 1700 N/A
HP321-1 LT-R404A 115/60/1 2000 AJA2419ZXA
HP327-1 LT-R404A 115/60/1 2580 AJA2425ZXA
MP12FG LT-R404A 220-230/60/1 2111 N/A
MP14FG LT-R404A 220-230/60/1 2523 AJA2525ZXD
MT-R12
AYCM33 MT-R12 115/60/1 2800 N/A
AYM33 MT-R12 115/60/1 2800 N/A
AYM50 MT-R12 115/60/1 SPECIAL N/A
CM25 MT-R12 115/60/1 2540 N/A
CM33 MT-R12 115/60/1 3160 AKA9434AXA



Americold BW & Hupp	App-Ref	Volt/Hz/Ph	Btu/h	Tecumseh Model
LT-R134a (continued)				
GP16FE	LT-R134a	115/60/1	1440	AEA2413YXA
GRG105-1	LT-R134a	115/60/1	580	AEA1360YXA
GRG106-1	LT-R134a	115/60/1	670	AEA1360YXA
GRG107-1	LT-R134a	115/60/1	740	TPA1380YXA
GRG108-1	LT-R134a	115/60/1	840	TPA1380YXA
GRG109-1	LT-R134a	115/60/1	970	TPA1390YXA
GRG205-1	LT-R134a	115/60/1	580	AEA1360YXA, OIL COOLER
GRG206-1	LT-R134a	115/60/1	670	AEA1360YXA
GRG207-1	LT-R134a	115/60/1	740	TPA1380YXA
GRG208-1	LT-R134a	115/60/1	840	TPA1380YXA
GRG209-1	LT-R134a	115/60/1	970	TPA1390YXA
GRH104-1	LT-R134a	115/60/1	475	N/A
GRH105-1	LT-R134a	115/60/1	590	AEA1360YXA
GRH106-1	LT-R134a	115/60/1	675	AEA1360YXA
GRH107-1	LT-R134a	115/60/1	770	TPA1380YXA
GRH108-1	LT-R134a	115/60/1	880	TPA1380YXA
GRH109-1	LT-R134a	115/60/1	990	TPA1390YXA
GRH110-1	LT-R134a	115/60/1	1050	AEA2410YXA, TP1410YXA
RF107-1	LT-R134a	115/60/1	740	TPA1380YXA
RF108-1	LT-R134a	115/60/1	858	TPA1380YXA
RG107-1	LT-R134a	115/60/1	730	TPA1380YXA
RG108-1	LT-R134a	115/60/1	845	TPA1380YXA
RG109-1	LT-R134a	115/60/1	910	TPA1390YXA
RG111-1	LT-R134a	115/60/1	1150	AEA2410YXA, TPA1410YXA
RG113-1	LT-R134a	115/60/1	1300	AEA2413YXA
RG211-1	LT-R134a	115/60/1	1150	AEA2410YXA, TPA1410YXA
RG213-1	LT-R134a	115/60/1	1325	AEA2413YXA
RH106-1	LT-R134a	115/60/1	674	AEA1360YXA



RG211-12



3066



0027505

220V-240V 

50/60 Hz 

1.29 FLA 12.0 LRA

7:51 2407

3/5/1998

AMERICOLD

THERMALLY PROTECTED

R134a * 1623-3566



Compressor, ZMC, EGM99AZ, 1/4 Hp, 1PH, R134a, LBP, 220-240V 50Hz

Category: compressor

written by www.mbsm.pro | 25 January 2021



Private Picture Copyright: WWW.MBSM.PRO



Private Picture Copyright: WWW.MBSM.PRO

General Data

R134a	:Refrigerant
LBP	:Application
30°C to -10°C-	:Evaporating Temperature Range
220/240V/50 HZ	:Voltage/Frequency
Static	:Compressor Cooling
Capillary Tube	:Expansion Device
Multi - 96:120 pcs	:Packaging Quantity
CE-VDE-GOST	:Approvals



Private Picture Copyright: WWW.MBSM.PRO

Mechanical Data

cm ³ 350	:Oil Charge
ester	:Oil Type Configuration
cSt 19	:Oil Type Viscosity
kg 10.25	:Weight

Electrical Data

*RSIR / RSCR	:Motor Type
187-264V	:Voltage working range at 50 Hz
130°C	:Maximum Motor Temperature
A 10.19 / 14.49	:Locked Rotor Current
25.08Ω at 25°C	:Start Winding Resistance
Ω at 25°C 7.33	:Run Winding Resistance
ph 1	:Phase



Private Picture Copyright : WWW.MBSM.PRO

External Characteristics

(mm)	Internal Diameter
6.5	Suction Connector
4.9	Discharge Connector
6.5	Process Connector
Copper	Material

Electrical Components

PTC 14Ω	:Starting Device
T0137/xx	:Motor Protection



Private Picture Copyright : WWW.MBSM.PRO

Circuit Diagram for Mod 90 Terminal Board

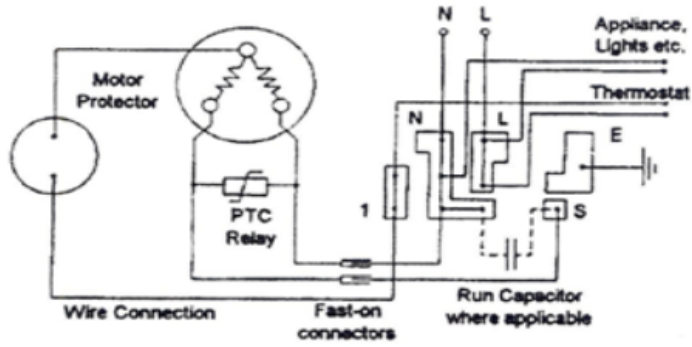

Circuit Diagram for U.H. Terminal Board

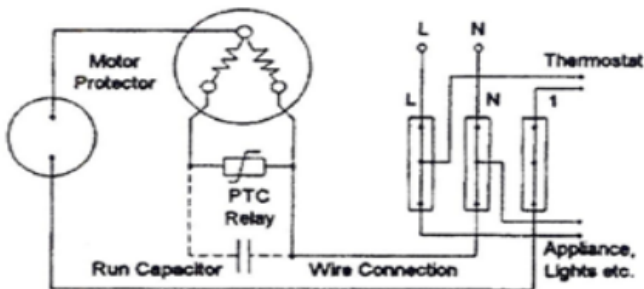

Private Picture Copyright : WWW.MBSM.PRO

PERFORMANCE CURVE DATA:

EGM99AZ

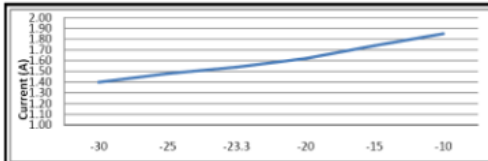
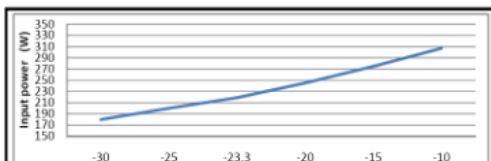
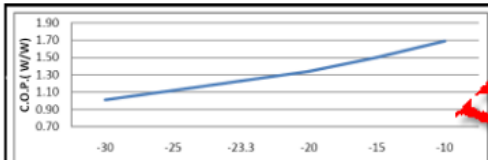
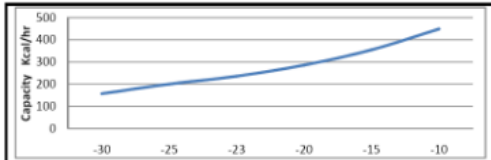

Test Condition: Ashrae, Static, Return Gas 32°C Subcooling OK, Evaporating: 23.3°C, Condensing: 55°C, Ambient: 32°C

Private Picture Copyright : WWW.MBSM.PRO



ZMC
R 134 a
EGM99AZ

Private Picture Copyright : WWW.MBSM.PRO

Mbsm_dot_pro_private_PDF_EGM99AZTélécharger

THG1374Y, TH271-ms-316, 1/4 HP, 192 W, Compresor Tecumseh , LBP

Category: compressor

written by www.mbsm.pro | 25 January 2021

Gas Refrigerante Refrigerant	Modelo del Compresor Compressor Model	Listado de Materiales Bill of Materials	Referencia Comercial Commercial Reference	Desplazamiento Displacement	50 Hz (ASHRAE)		60 Hz (ASHRAE)	
					Capacidad Friorogifrica Cooling Capacity -23,3°C (-10°F)	C.O.P.	Capacidad Friorogifrica Cooling Capacity -23,3°C (-10°F)	E.E.R.
					cm ³ /rev	W	W/W	Btu/h
R-134a	THB1324Y	TH324	1/14	2,72	62	0,93	250	3,47
	THG1330Y	TH261	1/10+	3,14	84	1,10	320	4,00
	THG1335Y	TH251	1/8	3,40	92	1,12	370	4,11
	THG1340Y	TH201	1/8+	3,79	104	1,21	425	4,25
	THG1346Y	TH211	1/6	4,23	117	1,12	475	4,20
	THG1352Y	TH221	1/6+	5,01	135	1,20	525	4,37
	THG1358Y	TH231	1/5	5,60	154	1,17	600	4,17
	THG1365Y	TH241	1/5	5,90	167	1,16	640	4,27
	TSB1355Y	TS304	1/5	4,59	140	1,61	610	5,42
	TSB1360Y	TS305	1/5	5,23	149	1,53	640	5,11
	TPH1380Y	TP152	1/5+	6,53	204	1,40	880	5,18
	THG1374Y	TH271	1/4	6,95	192	1,28	760	4,20
	TSB1374Y	TS306	1/4	5,65	167	1,37	700	5,04
	TSB1380Y	TS307	1/4	6,53	191	1,49	820	5,36
	TSB1390Y	TS308	1/3	7,28	215	1,35	930	5,10
	TPH1410Y	TP154	1/3	8,37	270	1,40	1100	4,66
TPH1413Y	TP155	1/3+	10,86	315	1,29	1275	4,65	
TPH1415Y	TP156	1/2	12,52	363	1,34	1450	4,75	
R-600a	AZA1330M	AZ526	1/10	5,59	91	1,00	310	3,83
	TSB1335M	TS406	1/8	5,65	91	1,65	365	5,02
	THG1345M	TH671	1/8+	6,96	108	1,12	430	4,39
	TSB1340M	TS404	1/7	6,53	111	1,59	410	5,07
	TSB1345M	TS407	1/6	7,28	123	1,58	500	5,21
	THG1355M	TH681	1/5	8,20	138	1,35	-	-
	TSB1355M	TS408	1/5	8,36	141	1,65	580	5,69
	TSB1360M	TS409	1/5	9,32	167	1,58	675	5,87
	TSB1365M	TS410	1/4	9,98	179	1,50	725	5,53
	TSB1370M	TS411	1/4	10,87	189	1,58	750	5,64
	TSB1380M	TS412	1/4	11,69	202	1,52	800	5,56
	AZ1328D	AZ225	1/10	2,95	73	1,02	280	3,26
AZ1335D	AZ223	1/8	3,60	91	1,05	360	3,45	
AZ1340D	AZ222	1/6	4,00	105	1,05	410	3,47	

Private Picture Copyright : WWW.MBSM.PRO

THG1374Y, TH271-ms-316, 1/4 HP, 192 W, Compresor Tecumseh , LBP

L76CZ1, Donper, R134A, 220W, 220-240V/50-60HZ, 1Phase, 1/4 Hp, (+BIg = 1/3-Hp), compressor, Hermetic, refrigerator, RSIR, oil 250 ML

Category: compressor

written by www.mbsm.pro | 25 January 2021

Model	Application	Power supply	Refrigeration capacity	Power	Cylinder volume	Refrigerant	Motor	COP:	Weight	Working current
K230CZ1	Refrigerator	220v~240v /50Hz	230W	220W	8.3cm ³	R134a	RSIR	1.3W/W	9.7 ± 0.4kg	1.35A
K270CZ1	Refrigerator	220v~240v /50Hz	270W	220W	9.5cm ³	R134a	RSIR	1.3W/W	9.8 ± 0.4kg	1.5A
K325CZ1	Refrigerator	220v~240v /50Hz	325W	235W	11.4cm ³	R134a	CSIR	1.3W/W	9.9 ± 0.4kg	1.6A
K375CZ1	Refrigerator	220v~240v /50Hz	375W	310W	12.7cm ³	R134a	CSIR	1.3W/W	9.9 ± 0.4kg	2.1A
L58CZ1	Refrigerator	220v~240v /50Hz	150W	120W	5.8cm ³	R134a	RSIR	1.3W/W	7.8 ± 0.4kg	0.85A
L65CZ1	Refrigerator(200L~320L)	220v~240v /50Hz	170W	136W	6.5cm ³	R134a	:RSIR	1.25W/W	8.2 ± 0.4kg	1.15A
L72CZ1	Refrigerator(200L~370L)	220v~240v /50Hz	195W	150W	7.2cm ³	R134a	RSIR	1.3W/W	9.1 ± 0.4kg	1.04A
L76CZ1	Refrigerator(280L~360L)	220v~240v /50Hz	220W	170W	7.6cm ³	R134a	RSIR	1.32W/W	8.9 ± 0.4kg	1.4A
NE5165CZ	Refrigerator(1000L~2000L)	220v~240v /50Hz	850W	380W	9cm ³	R134a	RSIR	2.1W/W	11 ± 0.5kg	2.3A
NE6188CZ	Refrigerator(1000L~2000L)	220v~240v /50Hz	860W	410W	12.1cm ³	R134a	CSIR	2.0W/W	11 ± 0.5kg	2.6A
NE6210CZ	Refrigerator(1000L~2000L)	220v~240v /50Hz	1050W	500W	14.2cm ³	R134a	CSIR	2.1W/W	11.2 ± 0.5kg	3.5A

Private Picture Copyright : WWW.MBSM.PRO

L76CZ1, Donper, R134A, refrigerator, RSIR, 220W, 1/4 Hp, (+BIg), (1/3- HP), compressor, High Pressure, High Pressure ,