



BUZYAPsAN

Hakkımızda

1970 yılında beyaz eşya servisi ve yedek parça satışıyla ticari hayatına başlayan firmamız, ısıtma ve soğutma sistem ve malzemelerine dair aradığınız en kaliteli ve en güvenli ürünleri özenle hizmetinize sunmuştur.

52 yıldır samimiyetle hakkaniyetle sektöre hizmet veren BUZYAPSAN'ın faaliyet alanlarının başında; soğutma sistemleri, ısıtma sistemleri, elektrikli ev aletleri, beyaz eşya ve klima ürün, yedek parça ve satışı gelmektedir.

Bu faaliyetlerimize ilave olarak 2016 yılından itibaren BYS Soğutma adıyla Süt Soğutma ve Endüstriyel Soğutma Üniteleri İmalatını gerçekleştirerek bu alanda da müşterilerimizin yüzünü güldürmeye ve topyekun imalat, satış ve servis çalışmalarımızı yapmaya devam etmekteyiz.

Dört şubesi olan firmamız, soğutma ve ısıtma adına tüm yedek parça tedariklerinizde sizlere yardımcı olmak amacıyla 2003-2017 arası İç, Ege ve Akdeniz bölgelerine sıcak satış gerçekleştirmiş ve sizlerden gelen yoğun talep üzerine 2017 yılı itibariyle byssogutma.com adresiyle e-ticaret sistemine geçmiştir.

BUZYAPSAN SOĞUTMA Özverili çalışması, kaliteli ürünleri, güvenli satışı ve geniş servis ağıyla daha mükemmel ve daha seçenekli bir hizmet anlayışıyla farklı ihtiyaçlara çözüm üretmeyi hedefleyerek, kalitesinden ödün vermeden yıldan yıla büyüyerek ülkemiz insanına hizmet veren ve bu anlamda öncü isim olmayı kendine şiar edinmiştir.

BUZYAPSAN SOĞUTMA; SOĞUTMADA
BULACAĞINIZ SICAKLIK

İÇİNDEKİLER

SOĞUTMA	05
EL ALETLERİ	95
ENDÜSTRİYEL BUZDOLABI	117
EV TİPİ BUZDOLABI	135
HAVA PERDELERİ	155
ELEKTRİK VE PANO MALZEMELERİ	159
KLİMA	173
OTOMATİK ÇAMAŞIR MAKİNESİ	187
BULAŞIK MAKİNESİ	221
FIRIN	235
ISITICI	247
SÜPÜRGE	257



01

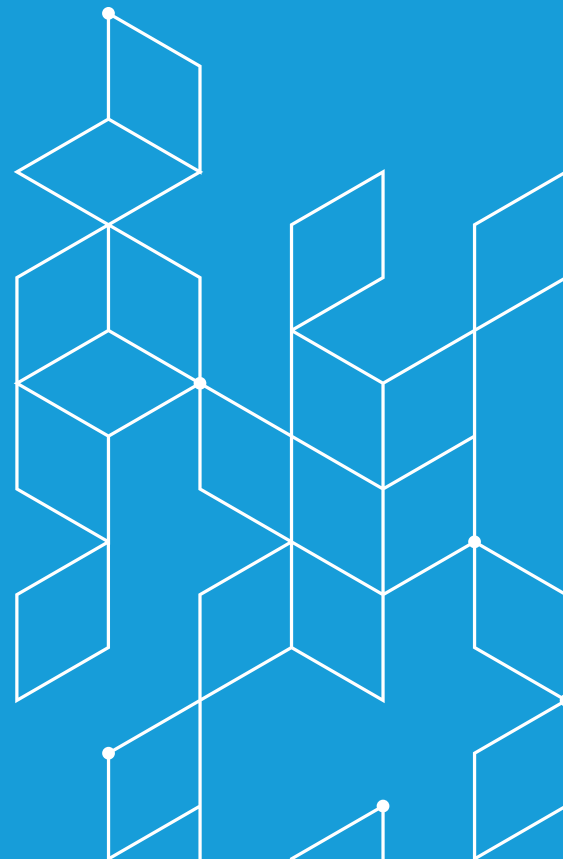

SOĞUTMA

KOMPRESÖRLER	06
SOĞUTUCU AKIŞKANLAR	35
KONDENSERLER	37
SOĞUTUCULAR	47
SOĞUK HAVA DEPOSU EKİPMANLARI	59
ISITICILAR	64
BAKIR BORULAR	66
BAKIR BAĞLANTI ELEMANLARI	67
TERMOSTATLAR	73
EXPANSION VALFLER	76
SOLENOID VALFLER	80
VANALAR	83
DRAYERLER	84
BASINÇ PROSESTATLARI	85
FANLAR VE AKSESUARLARI	87
LİKİT TUTUCULAR	89
YAĞ AYIRICILAR	89
LİKİT GAZ TANKLARI	90
TİTREŞİM ALICILAR	91
GAZ GÖZETLEME CAMLARI	92
YAĞLAR	92



SOĞUTMA

KOMPRESÖRLER

HERMETİK

embraco	MODEL	HP	GAZ CİNSİ	VOLTAJ	
	ERUS 60 HLP	1/6 Hp LBP 123Kcal	R134a	220V	
	EMYE 70 HEP	1/5 Hp LBP 144Kcal	R134a	220V	
	ERU2 80HSP	1/4+Hp 170Kcal	R134a	220V	
	EGAS 90 HLR	1/3 Hp (1/4+) 190Kcal	R134a	220V	
	EGAS 100 HLR	1/3 215Kcal	R134a	220V	
	FF 8.5 HBK	1/4 Hp 725Kcal	R134a	220V	
	FFI 12 HBK	3/8 Hp 1130Kcal	R134a	220V	
	EMT 6170 Z	1/4 Hp 680Kcal	R134a	220V	
	NEU 6210 Z	1/2 Hp 1050Kcal	R134a	220V	
	NT 6217 Z	3/4 Hp 1600Kcal	R134a	220V	
	NT 6220 Z	3/4 Hp 1730Kcal	R134a	220V	
	NEU 6214 E	1/2 Hp 1447 Kcal	R22	220V	
	NJ 9226 E	1 Hp 2600 Kcal	R22	220V	
		NJ 9232 E	1-1/4 Hp 3190 Kcal	R22	220V
NJ 9238 E		1-1/2 Hp 3850 Kcal	R22	220V	
NJ 9238 P		1-1/2 Hp 3850Kcal	R22	380V	
NEK 6181 GK		1/3 Hp 935Kcal	R404a	220V	
NEU 6212 GK		3/8 Hp 1236Kcal	R404a	220V	
NEU 6215 GK		1/2 Hp 1600Kcal	R404a	220V	
NEK 6217 GK		1/2 Hp 1785Kcal	R404a	220V	
NT 6222 GK		1 Hp 2150Kcal	R404a	220V	
NT 6226 GK		1 Hp 2885Kcal	R404a	220V	
NJ 9232 GK		1-1/4 Hp 3465Kcal	R404a	220V	
NJ 9238 GK		1-1/2 Hp 3970Kcal	R404a	220V	
NJ 9238 GS		1-1/2 Hp 4160Kcal	R404a	380V	
		NJX 6250 GS	2 Hp 5100Kcal	R404a	R404a
		EMT 2121 GK	1/3 Hp 258Kcal	R404a	R404a
	EMT 2125 GK	3/8 Hp 300Kcal	R404a	R404a	
	EMT 2130 GK	1/2 Hp 335Kcal	R404a	R404a	
	NEU 2140 GK	1/2 Hp 415Kcal	R404a	R404a	
	NEU 2155 GK	3/4 Hp 565Kcal	R404a	R404a	
	NEU 2168 GK	3/4 Hp 640Kcal	R404a	R404a	
	NEU 2178 GK	1 Hp 770Kcal	R404a	R404a	
	NT 2192 GK	1-1/4 Hp 905Kcal	R404a	R404a	
	NT 2212 GK	1-1/2 Hp 1180Kcal	R404a	R404a	
	NJ 2212 GK	1-1/2 Hp 1330Kcal	R404a	R404a	
	NJ 2212 GS	1-1/2 Hp 1270Kcal	R404a	R404a	
	NJX 2219 GS	2 Hp 1865Kcal	R404a	R404a	

KOMPRESÖRLER

HERMETİK

jaxipera	MODEL	HP	GAZ CİNSİ	VOLTAJ
	TT1116Y	1/5	R600A	220 V
	TT1117Y	1/4	R600A	220 V
	TT1117GY	1/4	R600A	220 V
	TT1119Y	1/4+	R600A	220 V
	NS1121Y	1/4+	R600A	220 V
	N1117Z	1/4	R134A	220 V
	N1118Z	1/4+	R134A	220 V



SECCP	MODEL	HP	GAZ CİNSİ	VOLTAJ
	GVM 44 AT	1/6 Hp 115Kcal	R134a	220V
	GVM 57 AT	1/5 Hp 140Kcal	R134a	220V
	GVM 66 AT	1/4 Hp 160Kcal	R134a	220V
	GVY 75 AN	1/4+ Hp 190Kcal	R134a	220V
	HMK 12 AA	1/4+ Hp 170Kcal	R600a	220V

cubigel® compressors	HP	MODEL	SOĞUTUCU GAZ	TEMP.	KCAL	VOLTAJ	CM	SOĞUTMA	MOTOR TİPİ
	1/3	L 76 TN	R 22	+ 7,2°C	820	220-240V 50Hz.	7,57	FAN	CSIR
	3/8	L 88 TN	R 22	+ 7,2°C	980	220-240V 50Hz.	8,86	FAN	CSIR
	1/2	P 12 TN	R 22	+ 7,2°C	1.323	220-240V 50Hz.	12,05	FAN	CSR
	3/4	S 18 TN-V	R 22	+ 7,2°C	2.050	220-240V 50Hz.	18,10	FAN	CSR
	1	S 22 TN-V	R 22	+ 7,2°C	2.500	220-240V 50Hz.	21,77	FAN	CSR
	1 1/4	S 26 TN-V	R 22	+ 7,2°C	3.051	220-240V 50Hz.	25,93	FAN	CSR
	1/5	GL 80 TB	R 134a	+ 7,2°C	570	220-240V 50Hz.	7,57	FAN	CSIR
	1/4	GL 90 TB	R 134a	+ 7,2°C	680	220-240V 50Hz.	8,85	FAN	CSIR
	3/8	GP 14 TB	R 134a	+ 7,2°C	1.030	220-240V 50Hz.	14,17	FAN	CSIR
	1/2	GP16TB	R 134a	+ 7,2°C	1.240	220-240V 50Hz.	16,15	FAN	CSIR
	1/2 +	GPY 16 Raa	R 134a	+ 7,2°C	1.351	220-240V 50Hz.	16,15	FAN	CSIR
	3/4	GX 23TB	R 134a	+ 7,2°C	1.780	220-240V 50Hz.	23,20	FAN	CSIR
	1	GS34TB-V	R 134a	+ 7,2°C	2.931	220-240V 50Hz.	34,42	FAN	CSR
	1/3	ML 80 TB	R 404A	+ 7,2°C	950	220-240 V 50 HZ	7,57	FAN	CSIR
	3/8	ML 90 TB	R 404A	+ 7,2°C	1.140	220-240 V 50 HZ	8,85	FAN	CSIR
	3/8+	MLT 12 RA	R 404A	+ 7,2°C	1.494	220-240 V 50 HZ	10,70	FAN	CSIR
	1/2	MPT 12 RA	R 404A	+ 7,2°C	1.685	220-240 V 50 HZ	12,10	FAN	CSR
	3/4	MPT 14 RA	R 404A	+ 7,2°C	1.900	220-240 V 50 HZ	14,32	FAN	CSR
3/4	MX 16 TBA	R 404A	+ 7,2°C	2.030	220-240 V 50 HZ	16,03	FAN	CSR	

KOMPRESÖRLER

HERMETİK

	HP	MODEL	SOĞUTUCU GAZ	TEMP.	KCAL	VOLTAJ	CM	SOĞUTMA	MOTOR TİPİ
		1	MX 21 TBA	R 404A	+ 7,2°C	2.620	220-240 V 50 HZ	20,72	FAN
1		MS 22 TB-V	R 404A	+ 7,2°C	2.790	220-240 V 50 HZ	21,75	FAN	CSR
1 3/8		MS 26 TB-V	R 404A	+ 7,2°C	3.449	220-240 V 50 HZ	25,93	FAN	CSR
1 1/2		MS 34 TB-V	R 404A	+ 7,2°C	4.551	220-240 V 50 HZ	34,42	FAN	CSR
1 1/2		MS 34 T3-V	R 404A	+ 7,2°C	4.551	400/440 V 50/60 HZ	34,42	FAN	TRİFAZE
1/3		ML 80 FB	R 404A	- 23,3°C	320	220-240 V 50 HZ	7,57	FAN	CSİR
3/8		ML 90 FB	R 404A	- 23,3°C	350	220-240 V 50 HZ	8,85	FAN	CSİR
1/2		MP 14 FB	R 404A	- 23,3°C	540	220-240 V 50 HZ	14,32	FAN	CSİR
3/4		MPT 14 LA	R 404A	- 23,3°C	670	220-240 V 50 HZ	14,32	FAN	CSR
1		MPT 16 LA	R 404A	- 23,3°C	765	220-240 V 50 HZ	16,15	FAN	CSR
1+		MPT 18 LA	R 404A	- 23,3°C	830	220-240 V 50 HZ	18,00	FAN	CSR
1		MX 23 FB	R 404A	- 23,3°C	915	220-240 V 50 HZ	23,20	FAN	CSR
1 1/2		MS 34 FB-V	R 404A	- 23,3°C	1.400	220 V 50 HZ	34,42	FAN	CSR
1 1/2		MS 34 F3-V	R 404A	- 23,3°C	1.400	400/440 V 50/60 HZ	34,42	FAN	TRİFAZE



	MODEL	HP	GAZ CİNSİ	VOLTAJ
		E100CL(AL)	1/5	R600a
E190CA		1/4	R600a	190W
E130CL(AL)		1/4+	R600a	225W
E55HBL(AL)		1/6	R134a	145W
E60HBL(AL)		1/5	R134a	170W
E70HBL(AL)		1/4	R134a	190W
E80HBL(AL)		1/4+	R134a	225W

	MODEL	HP	GAZ CİNSİ	VOLTAJ
		HVY75AA	1/4	R600
HVYX9AA		1/4+	R600	220 V
GVY75AA		1/4+	R134	220 V



KOMPRESÖRLER

HERMETİK

	MODEL	HP	GAZ CİNSİ	VOLTAJ
	BKT660AA	1/4 Hp 170 Kcal	R134a	220V
	BKT770AA	1/4+ Hp 185 Kcal	R134a	220V
	BKT120AA	1/4+ Hp 174 Kcal	R600a	220V

	MODEL	HP	GAZ CİNSİ	VOLTAJ
	GL 45 TB	1/6 HP	R-134A	220 V
	GL 60 TB	1/5 HP	R-134A	220 V
	GL 80 TB	1/5 HP	R-134A	220 V
	GL 90 TB	1/4 HP	R-134A	220 V
	GP 12 TB	1/3+ HP	R-134A	220 V
	GP 14 TB	3/8+ HP	R-134A	220 V
	GP 16 TB	1/2 HP	R-134A	220 V

	GM 35 AF	1/8 HP	R134A	220 V
	GM 55 AF	1/6 HP	R134A	220 V
	GM 70 AF	1/5 HP	R134A	220 V
	GM 75 AF	1/4 HP	R134A	220 V
	GM 80 AF	1/4+ HP	R134A	220 V
	GM 80 AF+	1/4+ HP	R-134A	220 V
	GM 90 AF	1/3 HP	R-134A	220 V
	GM 99 AZ	1/3 HP	R-134A	220 V
	GP 12 FB	1/2 HP	R-134A	220 V
	HL 80 AH	1/4 HP	R 600A	220 V
	HPT14AH	1/3+ HP	R600	220 V

	MODEL	BAĞLANTI ŞEKLİ	HP	VOLTAJ
	CR 22 K6ME PF1 111	KAYNAKLI	1,5	220
	CR 22 K6ME TFM 111	KAYNAKLI	1,5	380
	CR 24 K6ME PFZ 135	VANA BAĞLANTILI	2	220
	CR 24 K6E TFD 132	VANA BAĞLANTILI	2	380
	CR 28 K6E TFD 525	KAYNAKLI	2,3	380
	CR 30 K6ME PFZ 135	VANA BAĞLANTILI	2,5	220
	CR 30 K6ME TFM 111	KAYNAKLI	2,5	380
	CR 34 K6ME PFZ 135	VANA BAĞLANTILI	3	220



KOMPRESÖRLER



HERMETİK

	MODEL	BAĞLANTI ŞEKLİ	HP	VOLTAJ
	CR 34 K6ME TFD 132	VANA BAĞLANTILI	3	380
	CR 42 K6ME TFM 135	VANA BAĞLANTILI	3,5	380
	CR 47 KQME TFD 201	KAYNAKLI	4	380
	CR 53 KQE TFD 556	KAYNAKLI	4	380
	CRP5 045E TFD 595	VANA BAĞLANTILI	4,5	380
	CR 57 KQME TFD 203	KAYNAKLI	5	380
	CR 62 KQME TFD 203	KAYNAKLI	6	380
	CS 11 K6ME TFM 132	VANA BAĞLANTILI	2	220
	CS 13 K6ME TFM 132	VANA BAĞLANTILI	2,3	380
	CS 17 K6ME TFM 132	VANA BAĞLANTILI	3	380
	CS 20 K6ME TFM 132	VANA BAĞLANTILI	3,5	380
	CS 27 KQME TFD 233	VANA BAĞLANTILI	4	380
	CS 33 KQME TFD 233	VANA BAĞLANTILI	5	380
		MODEL	HP	GAZ CİNSİ
	WJ 9490 Z	1 1/3 Hp	R404	220V
	WJ 9513 Z	1 1/2 Hp	R404	220V
	AW 7514 Z	2 Hp	R404	220V
	AW 9516 Z	2 1/2 Hp	R404	220V
	AW 5526 Z-9	2 Hp	R404	380V
	AW 5534 Z-9	2 1/2 Hp	R404	380V
	AW 5538 Z-9	3 Hp	R404	380V
	AW 5545 Z-9	4 Hp	R404	380V
	KA 5558 ZXG	5 Hp	R404	380V
	KA 5564 ZXG	5 Hp	R404	380V
	KA 5572 ZXG	7 Hp	R404	380V
	LA 5590 ZXG	8 Hp	R404	380V
	LA 5610 ZXG	9 Hp	R404	380V
	LA 5612 ZXG	10 Hp	R404	380V
	AW 2464 ZK	1 1/2 Hp	R404	220V
	AW 2495 ZK	2 Hp	R404	220V
	AW 2464 Z-9	1 1/2 Hp	R404	380V
	AW 2495 Z-9	2 Hp	R404	380V
	AW 2512 ZXG	3 Hp	R404	380V
	KA 2520 ZXG	5 Hp	R404	380V

KOMPRESÖRLER

HERMETİK

	MODEL	HP		
	Danfoss Hermetik Kompresörler, R.134a, R.404A, R.407C - Orta ve Yüksek Basınç			
	MTZ - 18	1,5		
	MTZ - 22	1,8		
	MTZ - 28	2,3		
	MTZ - 32	2,7		
	MTZ - 36	3		
	MTZ - 40	3,5		
	MTZ - 50	4		
	MTZ - 56	4,6		
	MTZ - 64	5		
	MTZ - 72	6		
	MTZ - 80	6,5		
	MTZ - 100	8,5		
	MTZ - 125	10		
	MTZ - 144	12		
	MTZ - 160	13		
	Danfoss Hermetik Kompresörler, R.404A, R507A - Alçak Basınç			
	NTZ - 048	1,8		
	NTZ - 068	2,3		
	NTZ - 096	3,5		
	NTZ - 108	3,75		
	NTZ - 136	5		
NTZ - 215	7,5			
NTZ - 271	8,5			

	HP	TİP	GAZ	ELEKTRİK	BAĞLANTI
	TİCARİ TİP MEDIUM R.404A				
	1/4	AE 4425 ZNBR	R.404A	220 V 50Hz/60Hz	Bakır Boru
	1/3	AE 4430 ZNBR			
	3/8	AE 4440 ZNBR			
	1/2	AE 4450 ZNBR			
	1/2 +	AE 4460 ZNBR			
	3/4	AE 4470 ZNBR			
	TİCARİ TİP MEDIUM R.404A				
	3/4	CAJ 9480 Z	R.404A	208 V / 220 V 50 Hz	Vana
	1	CAJ 9510 Z			
	1+	CAJ 9513 Z			
	1.3	CAJ 4517 Z			
1.5	CAJ 4519 Z				

KOMPRESÖRLER

HERMETİK

	HP	TİP	GAZ	ELEKTRİK	BAĞLANTI
	TİCARİ TİP MEDIUM R.404A				
	1.3	TAJ 4517 Z	R.404A	400 V - 50 Hz 440 V - 60 Hz	Vana
	1.5	TAJ 4519 Z			
	4	TAG 4546 Z - TUBE	R.404A	400 V - 50 Hz 440 V - 60 Hz	Bakır Boru
	4.5	TAG 4553 Z - TUBE			
	5	TAG 4561 Z - TUBE			
	6	TAG 4568 Z - TUBE			
	7	TAG 4573 Z - TUBE			
	8	TAG 4581 Z - TUBE			
	4	TAG 4546 Z	R.404A	400 V - 50 Hz 440 V - 60 Hz	Vana
	4.5	TAG 4553 Z			
	5	TAG 4561 Z			
	6	TAG 4568 Z			
	7	TAG 4573 Z			
	8	TAG 4581 Z			
	DERİN SOĞUTMA TİCARİ TİP LOW BACK - R.404A				
	3/8 +	AE 2420 ZNBR	R.404A	220 V 50Hz/60Hz	Bakır Boru
	1/2	AE 2425 ZNBR			
3/4	AE 2430 ZNBR				
DERİN SOĞUTMA TİCARİ TİP LOW BACK - R.404A					
1/2 +	CAJ 2428 Z	R.404A	208 V / 220 V 50 Hz	Vanalı	
3/4	CAJ 2432 Z				
3/4 +	CAJ 2440 Z				
1	CAJ 2446 Z				
1.5	CAJ 2464 Z				
1	TAJ 2446 Z	R.404A	400 V - 50 Hz 440 V - 60 Hz	Vanalı	
1.5	TAJ 2464 Z				
4	TAG 2513 Z - TUBE	R.404A	400 V - 50 Hz 440 V - 60 Hz	Bakır Boru	
5	TAG 2516 Z - TUBE				
7	TAG 2522 Z - TUBE				
8	TAG 2525 Z - TUBE				
4	TAG 2513 Z	R.404A	400 V - 50 Hz 440 V - 60 Hz	2 Vanalı	
5	TAG 2516 Z				
7	TAG 2522 Z				
8	TAG 2525 Z				
					

KOMPRESÖRLER

HERMETİK





HP	TİP	GAZ	ELEKTRİK	BAĞLANTI
TİCARİ TİP MEDIUM / HIGH BACK - R.134a				
1.5	FH 4518 Y - XC	R.134a	220 V / 240 V 50 Hz	Vana
2	FH 4525 Y - XC			
1.5	FH 4518 Y - XG	R.134a	380-420 V - 50 Hz 460 V - 60 Hz	Vana
2	FH 4525 Y - XG			
TİCARİ TİP LOW BACK - R.404A				
2	FH 2480 Z - XC TUBE	R.404A	220 V / 240 V 50 Hz	Bakır Boru
3	FH 2511 Z - XC TUBE			
2	FH 2480 Z - XC	R.404A	220 V / 240 V 50 Hz	Vana
3	FH 2511 Z - XC			
2	FH 2480 Z - XG TUBE	R.404A	380-420 V / 50 Hz 460 V / 60 Hz	Bakır Boru
3	FH 2511 Z - XG TUBE			
2	FH 2480 Z - XG	R.404A	380-420 V / 50 Hz 460 V / 60 Hz	Vana
3	FH 2511 Z - XG			
TİCARİ TİP MEDIUM / HIGH BACK - R.404A				
2	FH 4524 Z - XC	R.404A	220 V / 240 V 50 Hz	Vana
2.5	FH 4532 Z - XC			
3	FH 4538 Z - XC			
2	FH 4524 Z - XG TUBE	R.404A	380-420 V / 50 Hz 460 V / 60 Hz	Bakır Boru
2.5	FH 4532 Z - XG TUBE			
3	FH 4538 Z - XG TUBE			
4	FH 4544 Z - XG TUBE			
2	FH 4524 Z - XG	R.404A	380-420 V / 50 Hz 460 V / 60 Hz	Vana
2.5	FH 4532 Z - XG			
3	FH 4538 Z - XG			
4	FH 4544 Z - XG			

KOMPRESÖRLER



HERMETİK

	HP	MODEL	VOLTAJ	TEMP	SOĞUTUCU GAZ	KCAL	BAGLANTI TİPİ
	2	QR 44	220V/50Hz	7,2°C	R 404A	5.140	VANALI
	2,5	QR 58	220V/50Hz	7,2°C	R 404A	6.852	VANALI
	2	QR3-44	380V/50Hz	7,2°C	R 404A	5.140	VANALI
	2,5	QR3-58	380V/50Hz	7,2°C	R 404A	6.852	VANALI
	3	QR3-74	380V/50Hz	7,2°C	R 404A	8.440	VANALI
	4	QR3-90	380V/50Hz	7,2°C	R 404A	9.718	VANALI
	5	QR3-112	380V/50Hz	7,2°C	R 404A	12.711	VANALI
	6	QR3-124	380V/50Hz	7,2°C	R 404A	14.319	VANALI
	7	QR3-134	380V/50Hz	7,2°C	R 404A	15.678	VANALI
	2,5	QL 52	220V/50Hz	-23,3°C	R 404A	2.069	VANALI
	3	QL 62	220V/50Hz	-23,3°C	R 404A	2.708	VANALI
	2,5	QL3 - 52	380V/50Hz	-23,3°C	R 404A	2.069	VANALI
	3	QL3 - 74	380V/50Hz	-23,3°C	R 404A	3.156	VANALI
	5	QL3 - 112	380V/50Hz	-23,3°C	R 404A	4.350	VANALI
	7	QL3 - 134	380V/50Hz	-23,3°C	R 404A	5.520	VANALI
	3/8+	MLT 12 RA	R 404A	+ 7,2°C	1.494	220-240 V 50 HZ	10,70
	1/2	MPT 12 RA	R 404A	+ 7,2°C	1.685	220-240 V 50 HZ	12,10
	3/4	MPT 14 RA	R 404A	+ 7,2°C	1.900	220-240 V 50 HZ	14,32
3/4	MX 16 TBA	R 404A	+ 7,2°C	2.030	220-240 V 50 HZ	16,03	

	MODEL	HP	GAZ CİNSİ	VOLTAJ
	WD 30 G		R134a	12-24V

KOMPRESÖRLER

ROTARY

	MODEL	BTU	GAZ CİNSİ
	QKS164HMA	9220	R22
	QK222PFA	13250	R22
	QJ306PCB	18300	R22
	QP407PAA	24100	R22
	QP442PBA	26000	R22

KOMPRESÖRLER

ROTARY

TOSHIBA AIR CONDITIONING	MODEL	BTU	GAZ CİNSİ
	PH160G1C-4DZDE2	9503	R22
	PH215M1A-4FT2	12727	R22
	PH295M2AS-4KUH1	18460	R22
	PH400G2CS-4KU1	24243	R22
	PH480X3CS-4MU1	28866	R22
	PA108M1C-4DZDE2	9000	R410
	PA145G1C-4FT1	12350	R410
	PA215M2AS-4KU	18000	R410
	PA270G2CS-4MU1	24000	R410

KOMPRESÖRLER

SCROLL

FRIO	MODEL	TİP	HP	SİLİNDİR HACMİ	EVAPARASYON 7,2 C	GAZ TİPİ	VOLTAJ
	WR36KE-PFJ	ORTA - YÜKSEK BASINÇ	3	8,1	8780W	R407C	220-240 V
	WR42KE-PFJ	ORTA - YÜKSEK BASINÇ	3,5	9,8	9610W	R407C	220-240 V
	WR36KE-TFD	ORTA - YÜKSEK BASINÇ	3	8,1	8450W	R407C	380-420 V
	WR42KE-TFD	ORTA - YÜKSEK BASINÇ	3,5	9,8	9920W	R407C	380-420 V
	WR48KE-TFD	ORTA - YÜKSEK BASINÇ	4	11,4	11500W	R407C	380-420 V
	WR61KE-TFD	ORTA - YÜKSEK BASINÇ	5	14,4	15100W	R407C	380-420 V
	WR72 KE-TFD	ORTA - YÜKSEK BASINÇ	6	17,2	16500W	R407C	380-420 V
	WR81 KE-TFD	ORTA - YÜKSEK BASINÇ	7	18,8	18900W	R407C	380-420 V
	WR94 KE-TFD	ORTA - YÜKSEK BASINÇ	8	22,1	22700W	R407C	380-420 V
	WR108 KE-TFD	ORTA - YÜKSEK BASINÇ	9	25,5	26100W	R407C	380-420 V
	WR125 KE-TFD	ORTA - YÜKSEK BASINÇ	10	29,1	30200W	R407C	380-420 V
	WR144 KE-TFD	ORTA - YÜKSEK BASINÇ	12	33,2	34700W	R407C	420V
	WR160 KE-TFD	ORTA - YÜKSEK BASINÇ	13	36,3	37200W	R407C	420V
WR110 KE-TFD	ORTA - YÜKSEK BASINÇ	15	43,3	43700W	R407C	420V	

KOMPRESÖRLER

SCROLL

Panasonic



Orta - Yüksek Basınç

MODEL	TİP	HP	SİLİNDİR HACMİ (CC)	DEPLASMAN (m ³ /hr)	R-404A -10 °C Evap. 45 °C Cond. (WATT)	R-407C 7,4 °C Evap. 54,4 °C Cond. (BTU)	FAZ
R-404 A / R-407 C / R-134 A / R-22							
CSBN 263 H8A	Standart	3,5	55,7	9,69	6.270	32.800	3
CSBN 303 H8G	Tandem	4	66,8	11,62	7.540	39.600	3
CSBN 353 H8G	Tandem	4,5	77,4	13,46	8.740	45.800	3
CSBN 373 H8G	Tandem	5	83,2	14,48	9.120	49.500	3
CSBN 453 H8G	Tandem	6	100	17,4	11.340	60.100	3
CSBS 235 H38B	Tandem	7	110,2	19,17	12.090	66.600	3
CSCN 583 H8K	Tandem	8	131,9	22,95	14.480	80.600	3
CSCN 603 H8K	Tandem	8	137	23,84	13.860	83.600	3
CSCN 673 H8K	Tandem	9	148,8	25,89	16.250	90.500	3
CSCN 753 H8K	Tandem	10	171,2	29,79	18.850	102.100	3
CSCN 903 H8K	Tandem	12	205,4	35,74	22.030	119.200	3
R-22							
CSB 263 H8A	Standart	3,5	55,7	9,69	5.650	31.200	3
CSBX 120 H38A	Standart	3,5	55,7	9,69	5.850	32.300	3
CSBR 235 H38A	Standart	7	110,2	19,17	11.390	65.600	3

MODEL	TİP	HP	SİLİNDİR HACMİ (CC)	DEPLASMAN (m ³ /hr)	R-410 A 7,4 °C Evap. 54,4 °C Cond. (WATT / BTU)		FAZ
R-410 A							
CSBN 263 H8D	Standart	3,5	37,5	6,52	8.851	30.200	3
CSBP 120 H38A	Standart	3,5	39,9	6,94	10.082	34.400	3
CSBN 303 H8H	Tandem	4	39,9	6,94	9.818	33.500	3
CSBN 353 H8D	Standart	4,5	51,8	9,01	13.013	44.400	3
CSBN 373 H8D	Standart	5	55,7	9,69	14.097	48.100	3
CSBN 373 H8H	Tandem	5	55,7	9,69	14.097	48.100	3
CSBP 170 H38A	Standart	5	55,7	9,69	14.332	48.900	3
CSBN 453 H8D	Standart	6	66,8	11,62	16.413	56.000	3
CSBN 453 H8H	Tandem	6	66,8	11,62	16.413	56.000	3
CSBN 523 H8D	Standart	7	77,4	13,46	19.226	65.600	3
CSBN 523 H8H	Tandem	7	77,4	13,46	19.226	65.600	3

KOMPRESÖRLER

SCROLL

Panasonic



MODEL	TİP	HP	SİLİNDİR HACMİ (CC)	DEPLASMAN (m ³ /hr)	R-410 A 7,4 °C Evap. 54,4 °C Cond. (WATT / BTU)		VFAZ
YÜKSEK / HIGH COP							
CSCP 270 H38A	Standart	8	89,2	15,51	22.421	76.500	3
CSCP 270 H38B	Tandem	8	89,2	15,51	22.421	76.500	3
CSCP 315 H38A	Standart	10	104,1	18,1	26.026	88.800	3
CSCP 315 H38B	Tandem	10	104,1	18,1	26.026	88.800	3
CSCP 360 H38A	Standart	11	120,2	20,9	29.807	101.700	3
CSCP 360 H38B	Tandem	11	120,2	20,9	29.807	101.700	3
CSCP 400 H38A	Standart	12	131,9	22,94	32.825	112.000	3
CSCP 400 H38B	Tandem	12	131,9	22,94	32.825	112.000	3
CSCP 435 H38B	Tandem	13	148,8	25,87	37.140	126.720	3
CSCP 510 H38B	Tandem	15	171,2	29,78	43.933	149.900	3

Low Pressure

MODEL	TİP	HP	SİLİNDİR HACMİ (CC)	DEPLASMAN (m ³ /hr)	R-404A -30 / +45 (WATT)		FAZ
CSBN 303 L8A	Tandem	4	66,8	11,62	2.200	6.200	3
CSBN 373 L8A	Tandem	5	83,2	14,48	2.900	8.170	3
CSBN 453 L8A	Tandem	6	96,2	16,74	4.070	9.660	3
CSCN 523 L8H	Tandem	7	120	20,88	4.430	11.280	3
CSCN 603 L8H	Tandem	8	137	23,84	4.920	12.690	3
CSCN 753 L8H	Tandem	10	171,2	29,79	5.920	16.250	3

Low Pressure

MODEL	INVERTER	SOĞUTUCU GAZ	HP	SİLİNDİR HACMİ	7,4 °C Evap. 54,4 °C Cond. BTU		7,4 °C Evap. 54,4 °C Cond. Watt	
CSDP205H02B INV	DC	R-410A	6	42,3	21.000	72.200	6.150	21.200
CSDP330H02B INV	DC	R-410A	10	66,8	33.100	113.200	9.700	33.200

MODEL	INVERTER	SOĞUTUCU GAZ	HP	SİLİNDİR HACMİ	R-404A -10 °C Evap 45 °C Cond. Watt		R-407C 7,4 °C Evap. 54,4 °C Cond. BTU	
					30 HZ	90 HZ	30 HZ	90 HZ
CSBS180H00B INV	AC	R-404A/407C/134A	6	55,7	2.270	10.730	4.700	18.650

MODEL	DRIVE	PANASONIC COMPRESSOR MODEL	GİRİŞ		ÇIKIŞ	HABERLEŞME	
			MAX GÜÇ	BESLEME GERİLİMİ	FREKANS	CONNECTOR	SERIAL PORT
HMD3W-2A	DC	CSDP205H02B INV	8 KW / 16A	380V/3/50-60HZ	15-100	RS485	RS232
HMD3W-2J	DC	CSDP330H02B INV	13KW / 26A				

KOMPRESÖRLER

SCROLL



MODEL	ÇALIŞMA REJİMİ	HP	ELEKTRİK BESLEMESİ	SOĞUTUCU AKIŞKAN	SOĞUTMA KAPASİTESİ (Watt)	EMİŞ HATTI	BASMA HATTI
JT95GBBY1L	HBP (+7,2°C / +54,4°C)	3	380V	R404A/R407C/R22/R134A	10.490	7/8"	5/8"
JT125GBBY1L	HBP (+7,2°C / +54,4°C)	4	380V	R404A/R407C/R22/R134A	13.250	7/8"	5/8"
JT160GBBY1L R404A	HBP (+7,2°C / +54,4°C)	5	380V	R404A/R407C/R22/R134A	16.720	7/8"	5/8"
JT170GBBY1L R404A	HBP (+7,2°C / +54,4°C)	6	380V	R404A/R407C/R22/R134A	17.890	7/8"	5/8"
JT212DAY1 R404A - 407C	HBP (+7,2°C / +54,4°C)	7 1/2	380V	R404A/R407C/R22/R134A	23.650	1"	3/4"
JT236DAYE R404A - 407C	HBP (+7,2°C / +54,4°C)	8	380V	R404A/R407C/R22/R134A	26.590	1 3/8"	3/4"
JT265DAY1 R404A	HBP (+7,2°C / +54,4°C)	9	380V	R404A/R407C/R22/R134A	29.450	1 3/8"	3/4"
JT300DA-Y1L R404A	HBP (+7,2°C / +54,4°C)	10	380V	R407C	32.790	1 3/8"	3/4"
JT335DA-Y1L R404A	HBP (+7,2°C / +54,4°C)	12	380V	R407C	37.250	1 3/8"	3/4"
JT90G-P8Y1 R410A	HBP (+7,2°C / +54,4°C)	2 3/4	380V	R410A	9.150	3/4"	5/8"
JT125L-P8Y1 R410A	HBP (+7,2°C / +54,4°C)	4	380V	R410A	13.380	3/4"	5/8"
JT160L-P8Y1 R410A	HBP (+7,2°C / +54,4°C)	4 1/2	380V	R410A	16.710	3/4"	5/8"
JT180L-P8Y1 R410A	HBP (+7,2°C / +54,4°C)	4 1/2	380V	R410A	16.710	3/4"	5/8"



MODEL	HP	SOĞUTUCU AKIŞKAN	SÜPÜRME HACMİ (m ³ /h 50hz)	VOLTAJ
ZR 22 K3E PFJ 522	2.0	R407C, R22, R134A	4,5	220 - 240V
ZR 28 K3E PFJ 522	2.5	R407C, R22, R134A	5.9	220 - 240V
ZR 22 K3E TFD 522	2.0	R407C, R22, R134A	4,5	380 - 420V
ZR 28 K3E TFD 522	2.5	R407C, R22, R134A	5.9	80 - 420V
ZR 34 K3E PFJ 522	2,8	R407C, R22, R134A	7,0	220 - 240V
ZR 34 K3E TFD 522	2,8	R407C, R22, R134A	8,0	380 - 420V
ZR 40 K3E TFD 522	3,5	R407C, R22, R134A	8,2	380 - 420V
ZR 40 K3E PFJ 522	3,5	R407C, R22, R134A	8,2	220 - 240V
ZR 48 K3E TFD 522	4	R407C, R22, R134A	10,1	380 - 420V
ZR 48 K3E PFJ 522	4	R407C, R22, R134A	10,1	20 - 240V
ZR 48 K3E TFD 422	4	R407C, R22, R134A	10,1	80 - 420V
ZR 61 KCE TFD 522	5	R407C, R22, R134A	12,5	380 - 420V
ZR 61 KCE TFD 422	5	R407C, R22, R134A	5,1	380 - 420V
ZR 72 KCE TFD 522	6	R407C, R22, R134A	14,4	380 - 420V

KOMPRESÖRLER

SCROLL

Copeland®
brand products



MODEL	HP	SOĞUTUCU AKIŞKAN	SÜPÜRME HACMİ (m ³ /h 50hz)	VOLTAJ
ZR 72 KCE TFD 422	6	R407C, R22, R134A	14,8	380 - 420V
ZR 81 KCE TFD 522	6,8	R407C, R22, R134A	16,7	380 - 420V
ZR 81 KCE TFD 422	6,8	R407C, R22, R134A	16,7	380 - 420V
ZR 94 KCE TFD 455	8	R407C, R22, R134A	20,6	380 - 420V
ZR 108 KCE TFD 455	9	R407C, R22, R134A	23	380 - 420V
ZR 125 KCE TFD 455	10	R407C, R22, R134A	27	380 - 420V
ZR 144 KCE TFD 455	12	R407C, R22, R134A	30,9	380 - 420V
ZR 160 KCE TFD 455	13	R407C, R22, R134A	33,4	380 - 420V
ZR 190 KCE TFD 455	15	R407C, R22, R134A	39,3	380 - 420V
ZR 250 KCE TWD 522	20	R407C, R22, R134A	56,6	380 - 420V
ZR 310 KCE TWD 522	25	R407C, R22, R134A	71,4	380 - 420V
ZR 380 KCE TWD 522	30	R407C, R22, R134A	87,3	380 - 420V
ZR 90 K3E TWD 961	7,5	R407C, R22, R134A	18,7	380 - 420V
ZR 11 M3E TWD 961	9		20,7	380 - 420V
ZR 12 M3E TWD 961	10	R407C, R22, R134A	26,3	380 - 420V
ZR 16 M3E TWD 961	13	R407C, R22, R134A	32,2	380 - 420V



ZR 19 M3E TWD 961	15	R407C, R22, R134A	39,4	380 - 420V
ZP 24 K5E TFD 522	1,9	R410A		380 - 420V
ZP 24 K5E PFJ 522	1,9	R410A		220 - 240V
ZP 29 K5E PFJ 522	2,5	R410A		220 - 240V
ZP 31 K5E PFJ 522	2,7	R410A		220 - 240V
ZP 36 K5E PFJ 522	2,9	R410A		220 - 240V
ZP 36 K5E TFM 522	2,9	R410A		380 - 420V
ZP 42 K5E TFD 522	3,5	R410A		380 - 420V
ZP 54 K5E TFD 522	4,6	R410A		380 - 420V
ZP 61 K5E TFD 522	5	R410A		380 - 420V
ZP 72 KCE TFD 522	6	R410A		380 - 420V
ZP 83 KCE TFD 522	7	R410A		380 - 420V
ZP 91 KCE TFD 522	8	R410A		380 - 420V
ZP 104 KCE TFD 522	9	R410A		380 - 420V
ZP 122 KCE TFD 455	10	R410A		380 - 420V
ZP 143 KCE TFD 455	12	R410A		380 - 420V
ZP 154 KCE TFD 455	13	R410A		380 - 420V
ZP 182 KCE TFD 455	15	R410A		380 - 420V
ZP 235 KCE TWD 522	20	R410A		380 - 420V
ZP 295 KCE TWD 522	25	R410A		380 - 420V
ZP 385 KCE TWD 522	30	R410A		380 - 420V
ZP 485 KCE TWD 522	40	R410A		380 - 420V

KOMPRESÖRLER

SCROLL

Copeland® brand products	MODEL	HP	SOĞUTUCU AKIŞKAN	SÜPÜRME HACMI (m ³ /h 50hz)	VOLTAJ
	ZB 15 KCE TFD 551	2.0	R407A, R407C, R407F, R22, R404A, R134A	3,3	380 - 420V
	ZB 19 KCE TFD 551	2.5	R407A, R407C, R407F, R22, R404A, R134A	4,2	380 - 420V
	ZB 21 KCE TFD 551	3.0	R407A, R407C, R407F, R22, R404A, R134A	5,1	380 - 420V
	ZB 26 KCE TFD 551	3,5	R407A, R407C, R407F, R22, R404A, R134A	5,8	380 - 420V
	ZB 30 KCE TFD 551	4	R407A, R407C, R407F, R22, R404A, R134A	6,9	380 - 420V
	ZB 38 KCE TFD 551	5	R407A, R407C, R407F, R22, R404A, R134A	8,5	380 - 420V
	ZB 45 KCE TFD 551	6	R407A, R407C, R407F, R22, R404A, R134A	10,1	380 - 420V
	ZB 48 KCE TFD 551	6,5	R407A, R407C, R407F, R22, R404A, R134A	11,9	380 - 420V
	ZB 50 KCE TFD 551	6,5	R407A, R407C, R407F, R22, R404A, R134A	11,9	380 - 420V
	ZB 58 KCE TFD 551	8	R407A, R407C, R407F, R22, R404A, R134A	13,3	380 - 420V
	ZB 66 KCE TFD 551	9	R407A, R407C, R407F, R22, R404A, R134A	15,1	380 - 420V
	ZB 76 KCE TFD 551	10	R407A, R407C, R407F, R22, R404A, R134A	17,9	380 - 420V
	ZB 95 KCE TFD 551	13	R407A, R407C, R407F, R22, R404A, R134A	21,7	380 - 420V
	ZB 114 KCE TFD 551	15	R407A, R407C, R407F, R22, R404A, R134A	43,4	380 - 420V
	ZB 220 KCE TFD 551	30		87,3	380 - 420V
	ZF 06 K4E TFD 556	2.0	R407A, R407C, R407F, R22, R404A, R134A	5.9	380 - 420V
	ZF 08 K4E TFD 556	2.5	R407A, R407C, R407F, R22, R404A, R134A	7,0	380 - 420V
	ZF 09 K4E TFD 556	2,8	R407A, R407C, R407F, R22, R404A, R134A	8,0	380 - 420V

KOMPRESÖRLER

SCROLL



MODEL	ÇALIŞMA REJİMİ	HP	ELEKTRİK BESLEMESİ	SOĞUTUCU AKIŞKAN	SOĞUTMA KAPASİTESİ (Watt)	EMİŞ HATTI	BASMA HATTI
MLZ 015 T5LP9	HBP (+7,2°C / +54,4°C)	2	220V	R404A	6.003	3/4"	1/2"
MLZ 021 T5LP9	HBP (+7,2°C / +54,4°C)	3	220V	R404A	8.374	3/4"	1/2"
MLZ 026 T5LP9	HBP (+7,2°C / +54,4°C)	3 1/2	220V	R404A	10.146	3/4"	1/2"
MLZ 030 T5LC9	HBP (+7,2°C / +54,4°C)	4	220V	R404A	12.185	7/8"	1/2"
MLZ 038 T5LC9	HBP (+7,2°C / +54,4°C)	5	220V	R404A	14.696	7/8"	1/2"
MLZ 015 T4LP9	HBP (+7,2°C / +54,4°C)	2	380V	R404A	4.890	3/4"	1/2"
MLZ 021 T4LP9	HBP (+7,2°C / +54,4°C)	3	380V	R404A	7.059	3/4"	1/2"
MLZ 026 T4LP9	HBP (+7,2°C / +54,4°C)	3 1/2	380V	R404A	10.258	3/4"	1/2"
MLZ 030 T4LC9	HBP (+7,2°C / +54,4°C)	4	380V	R404A	10.633	7/8"	1/2"
MLZ 038 T4LC9	HBP (+7,2°C / +54,4°C)	5	380V	R404A	12.672	7/8"	1/2"
MLZ 015 T5LP9	HBP (+7,2°C / +54,4°C)	2	220V	R404A	6.003	3/4"	1/2"
MLZ 021 T5LP9	HBP (+7,2°C / +54,4°C)	3	220V	R404A	8.374	3/4"	1/2"
MLZ 026 T5LP9	HBP (+7,2°C / +54,4°C)	3 1/2	220V	R404A	10.146	3/4"	1/2"
MLZ 030 T5LC9	HBP (+7,2°C / +54,4°C)	4	220V	R404A	12.185	7/8"	1/2"
MLZ 038 T5LC9	HBP (+7,2°C / +54,4°C)	5	220V	R404A	14.696	7/8"	1/2"
MLZ 015 T4LP9	HBP (+7,2°C / +54,4°C)	2	380V	R404A	4.890	3/4"	1/2"
MLZ 021 T4LP9	HBP (+7,2°C / +54,4°C)	3	380V	R404A	7.059	3/4"	1/2"
MLZ 026 T4LP9	HBP (+7,2°C / +54,4°C)	3 1/2	380V	R404A	10.258	3/4"	1/2"
MLZ 030 T4LC9	HBP (+7,2°C / +54,4°C)	4	380V	R404A	10.633	7/8"	1/2"
MLZ 038 T4LC9	HBP (+7,2°C / +54,4°C)	5	380V	R404A	12.672	7/8"	1/2"
MLZ 045 T4LC9	HBP (+7,2°C / +54,4°C)	6	380V	R404A	15.287	7/8"	1/2"
MLZ 048 T4LC9	HBP (+7,2°C / +54,4°C)	7	380V	R404A	19.315	7/8"	3/4"
MLZ 058 T4LC9	HBP (+7,2°C / +54,4°C)	8	380V	R404A	22.623	1 1/8"	7/8"
MLZ 066 T4LC9	HBP (+7,2°C / +54,4°C)	9	380V	R404A	26.232	1 1/8"	7/8"
MLZ 076 T4LC9	HBP (+7,2°C / +54,4°C)	10	380V	R404A	28.345	1 1/8"	7/8"
LLZ 013 T4LQ9	LBP (-23,3°C / +54,4°C)	4	380V	R404A	5.314	3/4"	1/2"
LLZ 015 T4LQ9	LBP (-23,3°C / +54,4°C)	5	380V	R404A	6.376	3/4"	1/2"
LLZ 018 T4LQ9	LBP (-23,3°C / +54,4°C)	6	380V	R404A	7.494	3/4"	1/2"
LLZ 024 T4LQ9	LBP (-23,3°C / +54,4°C)	8	380V	R404A	9.557	1 1/8"	3/4"
LLZ 034 T4LQ9	LBP (-23,3°C / +54,4°C)	10	380V	R404A	12.823	1 1/8"	3/4"
HRP 034 T5LP6	HBP (+7,2°C / +54,4°C)	2 3/4	220-240V	R404A/R407C/R22/R134A	7.900	3/4"	1/2"
HRP 034 T4LP6	HBP (+7,2°C / +54,4°C)	2 3/4	380V	R404A/R407C/R22/R134A	7.900	3/4"	1/2"
HRP 040 T4LP6	HBP (+7,2°C / +54,4°C)	3 1/3	380V	R404A/R407C/R22/R134A	9.100	3/4"	1/2"
HRP 048 T4LP6	HBP (+7,2°C / +54,4°C)	4	380V	R404A/R407C/R22/R134A	11.100	7/8"	1/2"

KOMPRESÖRLER

SCROLL



MODEL	ÇALIŞMA REJİMİ	HP	ELEKTRİK BESLEMESİ	SOĞUTUCU AKIŞKAN	SOĞUTMA KAPASİTESİ (Watt)	EMİŞ HATTI	BASMA HATTI
HRP 060 T4LP6	HBP (+7,2°C / +54,4°C)	5	380V	R404A/R407C/R22/R134A	13.900	7/8"	1/2"
HLP 072 T4LC6	HBP (+7,2°C / +54,4°C)	6	380V	R404A/R407C/R22/R134A	16.600	7/8"	1/2"
HLP 081 T4LC6	HBP (+7,2°C / +54,4°C)	6 1/2	380V	R404A/R407C/R22/R134A	19.500	7/8"	1/2"
HCP 109 T4LC7	HBP (+7,2°C / +54,4°C)	9	380V	R404A/R407C/R22/R134A	26.000	1 1/8"	7/8"
HCP 109 T4LC6	HBP (+7,2°C / +54,4°C)	9	380V	R404A/R407C/R22/R134A	26.000	1 1/8"	7/8"
HCP 120 T4LC7	HBP (+7,2°C / +54,4°C)	10	380V	R404A/R407C/R22/R134A	28.100	1 1/8"	7/8"
SZ 120-4VI / I	HBP (+7,2°C / +54,4°C)	10	380V	R407C	28.567	1 3/8"	7/8"
SZ 084-4VI / I	HBP (+7,2°C / +54,4°C)	7	380V	R407C	19.329	1 1/8"	3/4"
SZ 125-4RI (97.519)	HBP (+7,2°C / +54,4°C)	10 2/5	380V	R407C	28.565	1 3/8"	7/8"
SZ 090-4VI / I	HBP (+7,2°C / +54,4°C)	7 1/2	380V	R407C	20.396	1 1/8"	3/4"
SZ 100-4VI / I	HBP (+7,2°C / +54,4°C)	8 1/3	380V	R407C	21.586	1 1/8"	3/4"
SZ 148-4VAI / I	HBP (+7,2°C / +54,4°C)	12 1/3	380V	R407C	35.119	1 3/8"	7/8"
SZ 110-4VI / I	HBP (+7,2°C / +54,4°C)	9 1/6	380V	R407C	24.610	1 3/8"	7/8"
SZ 160-4RAI	HBP (+7,2°C / +54,4°C)	13 1/3	380V	R407C	38.585	1 5/8"	1 1/8"
SZ 115-4RI (91.650)	HBP (+7,2°C / +54,4°C)	9 3/5	380V	R407C	26.851	1 3/8"	7/8"
SZ 161-4VAI	HBP (+7,2°C / +54,4°C)	13 2/5	380V	R407C	38.007	1 3/8"	7/8"
SZ 175-4RI	HBP (+7,2°C / +54,4°C)	14 3/5	380V	R407C	40.126	1 5/8"	1 1/8"
SZ 185-4RI	HBP (+7,2°C / +54,4°C)	15 1/2	380V	R407C	43.113		
SY185-4RI	HBP (+7,2°C / +54,4°C)	15 1/2	380V	R407C	43.113	1 3/8"	7/8"
SY240A4PBI	HBP (+7,2°C / +54,4°C)	20	380V	R407C	59.136	1 5/8"	1 1/8"
SY300A4PBI	HBP (+7,2°C / +54,4°C)	25	380V	R407C	72.782	1 5/8"	1 1/8"
SY380A4CBI	HBP (+7,2°C / +54,4°C)	30	380V	R407C	89.600	1 5/8"	1 1/8"
HRH 036 U4LP6	HBP (+7,2°C / +54,4°C)	3	380V	R410A	8.800	3/4"	1/2"
HRH 040 U4LP6	HBP (+7,2°C / +54,4°C)	3 1/3	380V	R410A	10.200	3/4"	1/2"
HRH 044 U4LP6	HBP (+7,2°C / +54,4°C)	3 2/3	380V	R410A	10.800	7/8"	1/2"
HRH 054 U4LP6	HBP (+7,2°C / +54,4°C)	4 1/2	380V	R410A	13.300	7/8"	1/2"
HLH 061 T4LC6	HBP (+7,2°C / +54,4°C)	5 1/3	380V	R410A	14.800	7/8"	1/2"
HLJ 072 T4LC6	HBP (+7,2°C / +54,4°C)	6	380V	R404A/R407C/R22/R134A	17.800	7/8"	1/2"
HLJ 083 T4LC8	HBP (+7,2°C / +54,4°C)	7	380V	R410A	20.400	7/8"	1/2"
SH 090 - 120H0003	HBP (+7,2°C / +54,4°C)	8	380V	R410A	22.300	1 3/8"	7/8"

KOMPRESÖRLER



SCROLL



MODEL	ÇALIŞMA REJİMİ	HP	ELEKTRİK BESLEMESİ	SOĞUTUCU AKIŞKAN	SOĞUTMA KAPASİTESİ (Watt)	EMİŞ HATTI	BASMA HATTI
SH 105 - 120H0211	HBP (+7,2°C / +54,4°C)	9	380V	R410A	26.800	1 3/8"	7/8"
SH 120 - 120H0013	HBP (+7,2°C / +54,4°C)	10	380V	R410A	30.000	1 3/8"	7/8"
SH 140 - 120H0201	HBP (+7,2°C / +54,4°C)	12	380V	R410A	34.700	1 3/8"	7/8"
SH 161 - 120H0023	HBP (+7,2°C / +54,4°C)	13	380V	R410A	38.800	1 3/8"	7/8"
SH 180 - 120H0275	HBP (+7,2°C / +54,4°C)	15	380V	R410A	44.500	1 3/8"	7/8"
SH 295 - 120H0827	HBP (+7,2°C / +54,4°C)	20	380V	R410A	59.742	1 5/8"	1 1/8"
SH 240 - 120H0299	HBP (+7,2°C / +54,4°C)	20	380V	R410A	59.742	1 5/8"	1 1/8"
SH 300 - 120H0239	HBP (+7,2°C / +54,4°C)	25	380V	R410A	75.186	1 5/8"	1 1/8"
SH 380 - 120H0255	HBP (+7,2°C / +54,4°C)	30	380V	R410A	90.500	1 5/8"	1 1/8"
SH 485 - 120H1064	HBP (+7,2°C / +54,4°C)	40	380V	R410A	116.400	1 5/8"	1 1/8"

KOMPRESÖRLER

YARI HERMETİK

	MODEL (ESKİ MODEL)	SİLİNDİR HACMİ (m ³ /h-50Hz)	TANIMLAMA
	Bitzer Yarı Hermetik Pistonlu Kompresörler - Orta ve Yüksek Basınç. (R404a - R507a)		
	2KES-05Y (2KC-05.2Y)	4,06	Standart motor(1) , Yağ, Emme ve basma vanaları, 4 adet titreşim sönümleyici takoz, INT 69V/7-II elektronik kontrolü ile birlikte motor PTC sensörleri, IP65 koruma sınıfı terminal kutusu ve Karter ısıtıcısı(4) ile birlikte
	2JES-07Y (2JC-07.2Y)	5,21	
	2HES-2Y (2HC-2.2Y)	6,51	
	2FES-3Y (2FC-3.2Y)	9,54	
	2EES-3Y (2EC-3.2Y)	11,36	
	2DES-3Y (2DC-3.2Y)	13,42	
	2CES-4Y (2CC-4.2Y)	16,24	
	4FES-5Y (4FC-5.2Y)	18,05	
	4EES-6Y (4EC-6.2Y)	22,72	
	4DES-7Y (4DC-7.2Y)	26,84	
4CES-9Y (4CC-9.2Y)	32,48		
	4VES-10Y (4VCS-10.2Y)	34,73	Kısmi sargılı standart motor(3), Yağ, Koruyucu şarj, Emme ve basma vanaları, 4 adet titreşim sönümleyici takoz, INT 69VS elektronik kontrolü ile birlikte motor PTC sensörleri, IP54 korumasını terminal kutusu, Karter ısıtıcısı(4)
	4TES-12Y (4TCS-12.2Y)	41,33	
	4PES-15Y (4PCS-15.2Y)	48,5	
	4NES-20Y (4NCS-20.2Y)	56,25	
	4JE-22Y (4J-22.2Y)	63,5	
	4HE-25Y (4H-25.2Y)	73,6	
	4GE-30Y (4G-30.2Y)	84,5	
	6JE-33Y (6J-33.2Y)	95,3	
	4FE-35Y (YENİ)	101,8	
	6HE-35Y (6H-35.2Y)	110,5	
	6GE-40Y (6G-40.2Y)	126,8	
	6FE-50Y (6F-50.2Y)	151,6	
	8GE-60Y (8GC-60.2Y)	185	
	8FE-70Y (8FC-70.2Y)	221	

Açıklamalar

(1) 230 VΔ /380-420 V Y/3/50 Hz, 440-480 VY/3/60 Hz.

(2) 380-420 V YY/3/50 Hz, 440-480 V YY/3/60 Hz.

(3) 380-420 V YY/3/50 Hz, 440-480 V YY/3/60 Hz.

Sadece 6F-50.2 için: 380-400 V YY/3/50 Hz, 440-460 V YY/3/60 Hz.

(4) 230 V/1/50 & 60 Hz

2KC-05.2 (Y) ... 2FC-3.2 (Y) : 0 - 60 W sıcaklık kontrollü PTC ısıtıcı

2EC-2.2 (Y) ... 4CC-6.2 (Y) : 0 - 120 W sıcaklık kontrollü PTC ısıtıcı



4Z-5.2 (Y) ... 4N-20.2 (Y) : 100 W

4J-13.2 (Y) ... 6F-50.2 (Y) : 140 W

* Diğer aksesuarlar için lütfen firmamızı arayınız.

KOMPRESÖRLER

YARI HERMETİK

	MODEL (ESKİ MODEL)	SİLİNDİR HACMİ (m ³ /h-50Hz)	TANIMLAMA
	Bitzer Yarı Hermetik Pistonlu Kompresörler - Alçak ve Orta Basınc. (R404a - R507a)		
	2KES-05Y (2KC-05.2Y)	4,06	Standart motor(1) , Yağ, Emme ve basma vanaları, 4 adet titreşim sönümleyici takoz, INT 69V/7-II elektronik kontrolü ile birlikte motor PTC sensörleri, IP65 koruma sınıfı terminal kutusu ve Karter ısıtıcısı(4) ile birlikte
	2JES-07Y (2JC-07.2Y)	5,21	
	2HES-1Y (2HC-1.2Y)	6,51	
	2GES-2Y (2GC-2.2Y)	7,58	
	2FES-2Y (2FC-2.2Y)	9,54	
	2EES-2Y (2EC-2.2Y)	11,36	
	2DES-2Y (2DC-2.2Y)	13,42	
	2CES-3Y (2CC-3.2Y)	16,24	
	4FES-3Y (4FC-3.2Y)	18,05	
	4EES-4Y (4EC-4.2Y)	22,72	
	4DES-5Y (4DC-5.2Y)	26,84	Kısmi sargılı standart motor(3), Yağ, Koruyucu şarj, Emme ve basma vanaları, 4 adet titreşim sönümleyici takoz, INT 69VS elektronik kontrolü ile birlikte motor PTC sensörleri, IP54 korumasını terminal kutusu, Karter ısıtıcısı(4)
	4CES-6Y (4CC-6.2Y)	32,48	
	4VES-7Y (4VCS-6.2Y)	34,7	
	4TES-9Y (4TCS-8.2Y)	41,3	
	4PES-12Y (4PCS-10.2Y)	48,5	
	4NES-14Y (4NCS-12.2Y)	56,2	
	4JE-15Y (4J-13.2Y)	63,5	
	4HE-18Y (4H-15.2Y)	73,7	
	4GE-23Y (4G-20.2Y)	84,6	
6JE-25Y (6J-22.2Y)	95,3		
4FE-28Y (YENİ)	101,8		
6HE-28Y (6H-25.2Y)	110,5		
6GE-34Y (6G-30.2Y)	126,8		
6FE-44Y (6F-40.2Y)	151,6		

Açıklamalar

1) 230 VΔ /380-420 V Y/3/50 Hz, 440-480 VY/3/60 Hz.

(2) 380-420 V YY/3/50 Hz, 440-480 V YY/3/60 Hz.

(3) 380-420 V YY/3/50 Hz, 440-480 V YY/3/60 Hz.

Sadece 6F-50.2 için: 380-400 V YY/3/50 Hz, 440-460 V YY/3/60 Hz.

(4) 230 V/1/50 & 60 Hz

2KC-05.2 (Y) ... 2FC-3.2 (Y) : 0 - 60 W sıcaklık kontrollü PTC ısıtıcı

2EC-2.2 (Y) ... 4CC-6.2 (Y) : 0 - 120 W sıcaklık kontrollü PTC ısıtıcı



4Z-5.2 (Y) ... 4N-20.2 (Y) : 100 W

4J-13.2 (Y) ... 6F-50.2 (Y) : 140 W

* CIC ve diğer aksesuarlar için lütfen firmamızı arayınız.



KOMPRESÖRLER

YARI HERMETİK

	MODEL (ESKİ MODEL)	SİLİNDİR HACMİ m ³ /h (A.B. / Y.B.)		TANIMLAMA
	Bitzer Çift Kademeli Kompresörler (R404a - R507a)			
	S4T-5.2-Y		19,7 / 12,6	Standart motor(1) , Ester yağ, Koruyucu şarj, Emme ve basma vanaları, 4 adet titreşim sönümleyici takoz, INT 69V/7-II elektronik kontrolü ile birlikte motor PTC sensörleri, IP65 koruma sınıfı terminal kutusu ve Karter ısıtıcısı(4) ile birlikte
	S4N-8.2-Y		28 / 17,9	
	S4G-12.2-Y		42,3 / 27	
	S6J-16.2-Y		63,5 / 31,8	
	S6H-20.2-Y		73,6 / 36,9	
	S6G-25.2-Y		84,5 / 42,3	
	S6F-30.2-Y		101,1 / 50,5	

Açıklamalar

LS:Liquid Subcooler (Likit Enjeksiyon), Kompresörler standart olarak Likit enjeksiyon kiti montajlı olarak satılmaktadır.
 230 VΔ /380-420 V Y/3/50 Hz, 440-480 VY/3/60 Hz.
 380-420 V YY/3/50 Hz, 440-480 V YY/3/60 Hz.
 380-420 V YY/3/50 Hz, 440-480 V YY/3/60 Hz.
 Sadece 6F-50.2 için: 380-400 V YY/3/50 Hz, 440-460 V YY/3/60 Hz.
 230 V/1/50 & 60 Hz
 2KC-05.2 (Y) ... 2FC-3.2 (Y) : 0 - 60 W sıcaklık kontrollü PTC ısıtıcı
 2EC-2.2 (Y) ... 4CC-6.2 (Y) : 0 - 120 W sıcaklık kontrollü PTC ısıtıcı
 4Z-5.2 (Y) ... 4N-20.2 (Y) : 100 W
 4J-13.2 (Y) ... 6F-50.2 (Y) : 140 W
 R134a, R407C ve diğer soğutucu akışkanlarla kullanılacak kompresörler için lütfen firmamızı arayınız.
 CIC ve diğer aksesuarlar için lütfen firmamızı arayınız.

	MODEL (ESKİ MODEL)	SİLİNDİR HACMİ m ³ /h (A.B. / Y.B.)			TANIMLAMA
		30Hz	50Hz	87Hz	
	Bitzer Frekans İntertörlü Kompresörler				Standart motor(1) , Ester yağ, Koruyucu şarj, Emme ve basma vanaları, 4 adet titreşim sönümleyici takoz ve frekans invertörü
	2DC-3.F1Y	8,05	13,42	23,7	
	4FC-5.F1Y	11,03	18,05	32	
	4EC-6.F1Y	13,63	22,72	40,1	
	4DC-7.F1Y	16,1	26,84	47,3	
	4CC-6.F1Y	19,8	32,48	57,4	
	4DC-7.F3Y	16,1	26,84	47,3	
	4CC-9.F3Y	19,8	32,48	57,4	
	4VCS-10.F4Y	21,14	35,23	61,3	

KOMPRESÖRLER

YARI HERMETİK

SERİ SİLİNDİR	MODEL	BASMA HACMI	ÇALIŞMA ARALIĞI (°C)	MAKSİMUM ÇALIŞMA AKIMI (A)	KİLİTLİ MOTOR AKIMI	BAĞLANTI (mm)		YAĞ LİTRE
			R404A / R507	380-420V / 3 / 50Hz	EMME	BASMA		
DORIN H SERİSİ SEMİ HERMETİK KOMPRESÖRLER								
	H 51 CS	4,42	-5 - -45	1,8	9,0	12	12	1
	H 80 CC	4,42	+7,5 - -45	2,4	11,1	12	12	1
	H 80 CS	5,37	-5 - -45	2,4	11,1	16	12	1
	H 101 CC	5,37	+7,5 - -45	2,9	13,8	16	12	1
	H 101 CS	6,71	-5 - -45	2,9	13,8	16	12	1
	H 151 CC	6,71	+7,5 - -45	3,4	15,5	16	12	1
	H 151 CS	7,50	-5 - -45	3,4	15,5	16	12	1
	H 181 CC	7,50	+7,5 - -45	4,4	20,0	16	12	1
	H 181 CS	9,16	-5 - -45	4,4	20,0	16	12	1
	H 201 CC	9,16	+7,5 - -45	6,0	24,4	16	12	1
	H 201 CS	9,88	-5 - -45	4,4	20,0	18	16	1
	H 221 CC	9,88	+7,5 - -45	6,0	24,4	18	16	1
	H 221 CS	10,61	-5 - -45	6,0	24,4	18	16	1
	H 251 CC	10,61	+7,5 - -45	7,3	32,0	18	16	1
	H 251 CS	11,64	-5 - -45	6,0	24,4	18	16	1
	H 281 CC	11,64	+7,5 - -45	7,3	32,0	18	16	1
	H 281 SB	13,23	-5 - -45	6,0	24,4	18	16	1
	H 281 CS	13,23	-5 - -45	7,3	32,0	18	16	1
H1 / 2	H 180 CC	7,71	+7,5 - -45	4,4	20,0	16	12	1
	H 220 CC	9,88	+7,5 - -45	6,0	24,4	18	16	1
H2 / 2	H 290 CS	14,74	-5 - -45	7,5	34,2	22	16	1,4
	H 300 CC	14,74	+7,5 - -45	9,4	43,6	22	16	1,4
	H 300 CS	15,94	-5 - -45	7,5	34,2	28	16	1,4
	H 350 CC	15,94	+7,5 - -45	9,4	43,6	28	16	1,4
	H 350 SB	17,53	-5 - -45	7,5	34,2	28	16	1,4
	H 380 CC	17,53	+7,5 - -45	9,4	43,6	28	16	1,4
	H 380 SB	19,53	-20 - -45	7,5	34,2	28	16	1,4
	H 390 CS	19,53	-5 - -45	9,4	43,6	28	16	1,4
H32 / 2	H 392 CS	23,31	-20 - -45	11,3	53,8	28	16	1,4
	H 403 CC	19,98	+7,5 - -45	10,5	53,2	28	16	2
	H 403 CS	22,83	-5 - -45	10,5	53,2	28	16	2
	H 503 CC	22,83	+7,5 - -45	12,9	63,1	28	16	2
	H 503 CS	26,44	-5 - -45	12,9	63,1	35	16	2
H33 / 4	H 743 CC	26,44	+7,5 - -45	16,7	86,0	35	16	2
	H 355 CS	19,29	-5 - -45	10,5	53,00	22	16	1,8
	H 405 CC	19,29	+7,5 - -45	14,5	63,00	22	16	1,8
	H 405 CS	23,13	-5 - -45	10,5	53,00	28	16	1,8
	H 505 CC	23,13	+7,5 - -45	14,5	63,00	28	16	1,8
	H 505 CS	27,33	-5 - -45	14,5	63,00	28	16	1,8
	H 705 CC	27,33	+7,5 - -45	19,5	86,00	28	16	1,8
H 705 CS	31,88	-5 - -45	14,5	63,00	28	16	1,8	
H 755 CC	31,88	+7,5 - -45	19,5	86,00	28	16	1,8	



KOMPRESÖRLER

YARI HERMETİK

SERİ SİLİNDİR	MODEL	BASMA HACMI	ÇALIŞMA ARALIĞI (°C)	MAKSİMUM ÇALIŞMA AKIMI (A)	KİLİTLİ MOTOR AKIMI	BAĞLANTI (mm)		YAĞ LİTRE	
			R404A / R507	380-420V / 3 / 50Hz	EMME	BASMA			
DORIN H SERİSİ SEMİ HERMETİK KOMPRESÖRLER									
	H35 / 4	H 401 CS	19,29	-5 - -45	10,5	53,2	22	18	2
		H 451 CC	19,29	+7,5 - -45	14,5	63,1	22	18	2
		H 451 CS	23,13	-5 - -45	10,5	53,2	28	18	2
		H 551 CC	23,13	+7,5 - -45	14,5	63,1	28	18	2
		H 551 CS	27,33	-5 - -45	14,5	63,1	28	22	2
		H 701 CC	27,33	+7,5 - -45	19,5	86	28	22	2
		H 701 CS	31,88	-5 - -45	14,5	63,1	28	22	2
		H 751 CC	31,88	+7,5 - -45	19,5	86	28	22	2
		H 751 CS	38,06	-5 - -45	19,5	86	35	22	2
		H 1002 CC	38,06	+7,5 - -45	23	92	35	22	2
		H 801 CS	43,73	-5 - -45	19,5	86	35	22	2
		H 1003 CC	43,73	+7,5 - -45	23	92	35	22	2
H34 / 4	H 850 CB	45,67	-20 - -45	16,7	86,0	35	22	2	
H41 / 4	H 851 CS	42,81	-5 - -45	20	104,6	35	28	2,5	
	H 1201 CC	42,82	+7,5 - -45	28	134,7	35	28	2,5	
	H 1001 CS	48,82	-5 - -45	24	108,7	35	28	2,5	
	H 1501 CC	48,82	+7,5 - -45	34	170,5	42	28	2,5	
	H 1501 CS	56,87	-5 - -45	28	134,7	35	28	2,5	
	H 2001 CC	56,87	+7,5 - -45	38	177	42	28	2,5	
	H 1601 CS	63,76	-5 - -45	34	170,5	42	28	2,5	
	H 2201 CC	63,76	+7,5 - -45	45	203	42	28	2,5	
H5 / 4	H 2000 CS	75,83	-5 - -45	38	177	42	28	3,5	
	H 2500 CC	75,83	+7,5 - -45	48	203	54	28	3,5	
	H 2500 CS	85,01	-5 - -45	45	203	54	28	3,5	
	H 3000 CC	85,01	+7,5 - -45	56	224	54	28	3,5	
	H 2700 CS	92,25	-5 - -45	48	203	54	35	3,5	
	H 3200 CC	92,25	+7,5 - -45	60	260	54	35	3,5	
	H 2900 CS	102,35	-5 - -45	56	245	54	35	3,5	
	H 3400 CC	102,35	+7,5 - -45	60	260	54	35	3,5	
H6 / 6	H 3000 CS	113,74	-5 - -45	60	245	54	35	3,5	
	H 3500 CC	113,74	+7,5 - -45	66	260	54	35	3,5	
	H 3500 CS	127,52	-5 - -45	60	245	54	35	3,5	
	H 4000 CC	127,52	+7,5 - -45	75	290	54	35	3,5	
	H 4000 CS	138,37	-5 - -45	66	260	54	42	3,5	
	H 4500 CC	138,37	+7,5 - -45	84	323	54	42	3,5	
	H 4500 CS	153,52	-5 - -45	75	290	54	42	3,5	
	H 5000 CC	153,52	+7,5 - -45	93	358	54	42	3,5	
H7 / 8	H 5000 CS	164,30	-5--40	90	367	66	42	8,5	
	H 5500 CC	164,30	+10--40	105	455	66	42	8,5	
	H 5500 CS	184,19	-5--40	105	455	80	42	8,5	
	H 6000 CC	184,19	+10--40	120	544	80	42	8,5	
	H 6000 CS	199,86	-5--40	105	455	80	42	8,5	



KOMPRESÖRLER

YARI HERMETİK

	SERİ SİLİNDİR	MODEL	BASMA HACMİ	ÇALIŞMA ARALIĞI (°C)	MAKSİMUM ÇALIŞMA AKIMI (A)	KİLİTLİ MOTOR AKIMI	BAĞLANTI (mm)		YAĞ LİTRE
				R404A / R507	380-420V / 3 / 50Hz	EMME	BASMA		
	DORIN H SERİSİ SEMİ HERMETİK KOMPRESÖRLER								
	H7 / 8	H 7500 CC	199,86	+10--40	148	584	80	42	8,5
		H 7501 CS	221,75	-5--40	120	544	80	54	8,5
		H 8001 CC	221,75	+10--40	148	584	80	54	8,5
		H 8000 CS	244,78	-5--40	120	544	80	54	8,5
		H 9000 CC	244,78	+10--40	148	584	80	54	8,5

	DORIN ÇİFT KADEMELİ SEMİ HERMETİK KOMPRESÖRLER								
	SERİ SİLİNDİR	MODEL	BASMA HACMİ	ÇALIŞMA ARALIĞI (°C)	MAKSİMUM ÇALIŞMA AKIMI (A)	KİLİTLİ MOTOR AKIMI	BAĞLANTI (mm)		YAĞ LİTRE
2S-H5	2S-H1500	56,49+37,91	-25 - -60	34	170,5	42	28	3,5	
	2S-H6	2S-H2000	75,83+37,91	-25 - -60	38	177	42	35	3,5
		2S-H2500	85,01+42,51	-25 - -60	48	203	42	35	3,5
		2S-H3000	102,35+51,17	-25 - -60	56	224	54	35	3,5
		2S-H3500	112,97+56,49	-25 - -60	60	260	54	35	3,5
		2S-H4000	122,39+61,19	-25 - -60	72	290	54	35	3,5
2S-H7	2S-H5000	138,15+61,19	-25 - -60	90	367	66	42	8,5	
	2S-H6000	166,31+61,19	-25 - -60	105	455	66	42	8,5	
	2S-H6500	183,58+61,19	-25 - -60	105	455	66	42	8,5	

	DORIN ÇİFT KADEMELİ ULTRA DERİN SOĞUTMA SEMİ HERMETİK KOMPRESÖRLER								
	SERİ SİLİNDİR	MODEL	BASMA HACMİ	ÇALIŞMA ARALIĞI (°C)	MAKSİMUM ÇALIŞMA AKIMI (A)	KİLİTLİ MOTOR AKIMI	BAĞLANTI (mm)		YAĞ LİTRE
2S-H5	2S-H1200 L	56,49+37,91	-40 - -75	25	134,7	42	28	3,5	
	2S-H6	2S-H1500 L	75,83+37,91	-40 - -75	34	170,5	42	35	3,5
		2S-H2000 L	85,01+42,51	-40 - -75	38	177	42	35	3,5
		2S-H2500 L	102,35+51,17	-40 - -75	48	203	54	35	3,5
		2S-H3000 L	112,97+56,49	-40 - -75	56	224	54	35	3,5
		2S-H3200 L	122,39+61,19	-40 - -75	56	224	54	35	3,5

	SERİ SİLİNDİR	MODEL	BASMA HACMİ (m ³ /h)			MAKSİMUM ÇALIŞMA AKIMI (A)	KİLİTLİ MOTOR AKIMI	BAĞLANTI (mm)		YAĞ LİTRE
			20 Hz	50 Hz	90 Hz			EMME	BASMA	
	DORIN H SERİSİ SEMİ HERMETİK KOMPRESÖRLER									
	HI 11 / 2	HI 101 CC	2,21	5,53	9,95	5	24	18	12	1
		HI 151 CC	2,84	7,10	12,78	5,9	27	18	16	1
		HI 241 CC	3,81	9,52	17,14	12,6	55	22	16	1
	HI 34 / 4	HI 400 CC	6,60	16,50	29,70	17,2	75,3	28	16	2
		HI 35 / 4	HI 361 CC	5,40	13,50	24,30	18,1	92	28	22
	HI 421 CC		6,48	16,19	29,14	18,1	92	28	22	2
	HI 451 CC		7,72	19,29	34,72	22,5	109	28	22	2
	HI 551 CC		9,25	23,13	41,63	22,5	109	28	22	2
	HI 701 CC		10,93	27,33	49,19	29	149	35	28	2
	HI 751 CC		12,75	31,88	57,38	29	149	35	28	2
			20 Hz	50 Hz	75 Hz	400 V / 75 Hz DOL				
	HI 4 / 4	HI 101 CC	2,21	5,53	9,95	5	24	18	12	1
	HI 41 / 4	HI 151 CC	2,84	7,10	12,78	5,9	27	18	16	1
		HI 241 CC	3,81	9,52	17,14	12,6	55	22	16	1

KOMPRESÖRLER

YARI HERMETİK

SERİ SİLİNDİR	MODEL	BASMA HACMI	ÇALIŞMA ARALIĞI (°C)	MAKSİMUM ÇALIŞMA AKIMI (A)	KİLTLİ MOTOR AKIMI	BAĞLANTI (mm)		YAĞ LİTRE
			R404A / R507	380-420V / 3 / 50Hz	EMME	BASMA		
DORIN H ECO PREMIUM SERİSİ R134A İÇİN ÖZEL SEMİ HERMETİK KOMPRESÖRLER								
HEP 35	H 400 EP	19,29	+5--20	10,5	53	22	18	2
	H 450 EP	23,13	+5--20	10,5	53	28	18	2
	H 500 EP	27,33	+5--20	10,5	53	28	22	2
	H 550 EP	31,88	+5--20	10,5	53	28	22	2
	H 600 EP	38,06	+5--20	14,5	63	35	22	2
	H 650 EP	43,73	+5--20	14,5	63	35	22	2
HEP 41	H 700 EP	42,81	+5--20	20	105	35	28	2,5
	H 800 EP	48,82	+5--20	20	105	35	28	2,5
	H 1200 EP	56,87	+5--20	24	109	35	28	2,5
HEP 5	H 1300 EP	63,76	+5--20	24	109	42	28	2,5
	H 1400 EP	75,83	+5--20	26	135	42	28	3,5
	H 1500 EP	85,01	+5--20	26	135	54	28	3,5
HEP 6	H 1600 EP	92,25	+5--20	34	171	54	35	3,5
	H 1700 EP	102,35	+5--20	34	171	54	35	3,5
	H 2000 EP	113,74	+5--20	38	177	54	35	3,5
HEP 6	H 2400 EP	127,52	+5--20	48	203	54	35	3,5
	H 2600 EP	138,37	+5--20	48	203	54	42	3,5
	H 3000 EP	153,52	+5--20	56	245	54	42	3,5
HEP 6	H 4000 EP	164,3	+5--20	75	367	66	42	8,5
	H 4500 EP	184,19	+5--20	75	367	80	42	8,5
	H 5000 EP	199,86	+5--20	75	367	80	42	8,5
	H 6000 EP	221,75	+5--20	100	455	80	54	8,5
	H 7000 EP	244,78	+5--20	100	455	80	54	8,5





DORIN HEX SERİSİ (HC İÇİN) SEMİ HERMETİK KOMPRESÖRLER								
HEX11/2	HEX 51 CS	4,42	0 - -40	1,8	9,0	12	12	1
	HEX 80 CC	4,42	+10 - -40	2,4	11,1	12	12	1
	HEX 80 CS	5,37	0 - -40	2,4	11,1	16	12	1
	HEX 101 CC	5,37	+10 - -40	2,9	13,8	16	12	1
	HEX 101 CS	6,71	0 - -40	2,9	13,8	16	12	1
	HEX 151 CC	6,71	+10 - -40	3,4	15,5	16	12	1
	HEX 151 CS	7,50	0 - -40	3,4	15,5	16	12	1
	HEX 181 CC	7,50	+10 - -40	4,4	20,0	16	12	1
	HEX 181 CS	9,16	0 - -40	4,4	20,0	16	12	1
	HEX 201 CC	9,16	+10 - -40	6,0	24,4	16	12	1
	HEX 201 CS	9,88	0 - -40	4,4	20,0	18	16	1
	HEX 221 CC	9,88	+10 - -40	6,0	24,4	18	16	1
	HEX 221 CS	10,61	0 - -40	6,0	24,4	18	16	1
	HEX 251 CC	10,61	+10 - -40	7,3	32,0	18	16	1
	HEX 251 CS	11,64	0 - -40	6,0	24,4	18	16	1
	HEX 281 CC	11,64	+10 - -40	7,3	32,0	18	16	1



KOMPRESÖRLER

YARI HERMETİK

SERİ SİLİNDİR	MODEL	BASMA HACMİ	ÇALIŞMA ARALIĞI (°C)	MAKSİMUM ÇALIŞMA AKIMI (A)	KİLİTLİ MOTOR AKIMI	BAĞLANTI (mm)		YAĞ LİTRE	
			R404A / R507	380-420V / 3 / 50Hz		EMME	BASMA		
DORIN HEX SERİSİ (HC İÇİN) SEMİ HERMETİK KOMPRESÖRLER									
	HEX2 / 2	HEX 281 SB	13,23	0 - -40	6,0	24,4	18	16	1
		HEX 281 CS	13,23	0 - -40	7,3	32,0	18	16	1
		HEX 290 CS	14,74	0 - -40	7,5	34,2	22	16	1,4
		HEX 300 CC	14,74	+10 - -40	9,4	43,6	22	16	1,4
		HEX 300 CS	15,94	0 - -40	7,5	34,2	28	16	1,4
		HEX 350 CC	15,94	+10 - -40	9,4	43,6	28	16	1,4
		HEX 350 SB	17,53	0 - -40	7,5	34,2	28	16	1,4
		HEX 380 CC	17,53	+10 - -40	9,4	43,6	28	16	1,4
		HEX 380 SB	19,53	-20 - -40	7,5	34,2	28	16	1,4
		HEX 390 CS	19,53	0 - -40	9,4	43,6	28	16	1,4
	HEX 392 CS	23,31	-20 - -40	11,3	53,8	28	16	1,4	
	HEX32/2	HEX 403 CC	19,98	+10 - -40	10,5	53,2	28	16	2
		HEX 403 CS	22,83	0 - -40	10,5	53,2	28	16	2
		HEX 503 CC	22,83	+10 - -40	12,9	63,1	28	16	2
		HEX 503 CS	26,44	0 - -40	12,9	63,1	35	16	2
		HEX 743 CC	26,44	+10 - -40	16,7	86,0	35	16	2
	HEX33/4	HEX 355 CS	19,29	0 - -40	10,5	53,00	22	16	1,8
		HEX 405 CC	19,29	+10 - -40	14,5	63,00	22	16	1,8
		HEX 405 CS	23,13	0 - -40	10,5	53,00	28	16	1,8
		HEX 505 CC	23,13	+10 - -40	14,5	63,00	28	16	1,8
		HEX 505 CS	27,33	0 - -40	14,5	63,00	28	16	1,8
HEX 705 CC		27,33	+10 - -40	19,5	86,00	28	16	1,8	
HEX 705 CS		31,88	0 - -40	14,5	63,00	28	16	1,8	
HEX 755 CC	31,88	+10 - -40	19,5	86,00	28	16	1,8		

DORIN HEX SERİSİ (HC İÇİN) SEMİ HERMETİK KOMPRESÖRLER									
	HEX35/4	HEX 401 CS	19,29	0 - -40	10,5	53,2	22	18	2
		HEX 451 CC	19,29	+10 - -40	14,5	63,1	22	18	2
		HEX 451 CS	23,13	0 - -40	10,5	53,2	28	18	2
		HEX 551 CC	23,13	+10 - -40	14,5	63,1	28	18	2
		HEX 551 CS	27,33	0 - -40	14,5	63,1	28	22	2
		HEX 701 CC	27,33	+10 - -40	19,5	86	28	22	2
		HEX 701 CS	31,88	0 - -40	14,5	63,1	28	22	2
		HEX 751 CC	31,88	+10 - -40	19,5	86	28	22	2
		HEX 751 CS	38,06	0 - -40	19,5	86	35	22	2
		HEX 1002 CC	38,06	+10 - -40	23	92	35	22	2
		HEX 801 CS	43,73	0 - -40	19,5	86	35	22	2
		HEX 1003 CC	43,73	+10 - -40	23	92	35	22	2
	HEX41/4	HEX 851 CS	42,81	0 - -40	20	104,6	35	28	2,5
		HEX 1201 CC	42,82	+10 - -40	28	134,7	35	28	2,5
HEX 1001 CS		48,82	0 - -40	24	108,7	35	28	2,5	
HEX 1501 CC		48,82	+10 - -40	34	170,5	42	28	2,5	

KOMPRESÖRLER



YARI HERMETİK

SERİ SİLİNDİR	MODEL	BASMA HACMİ	ÇALIŞMA ARALIĞI (°C)	MAKSİMUM ÇALIŞMA AKIMI (A)	KİLİTLİ MOTOR AKIMI	BAĞLANTI (mm)		YAĞ LİTRE
			R404A / R507	380-420V / 3 / 50Hz		EMME	BASMA	
DORIN HEX SERİSİ (HC İÇİN) SEMİ HERMETİK KOMPRESÖRLER								
HEX41/4	HEX 1501 CS	56,87	0 - -40	28	134,7	35	28	2,5
	HEX 2001 CC	56,87	+10 - -40	38	177	42	28	2,5
	HEX 1601 CS	63,76	0 - -40	34	170,5	42	28	2,5
	HEX 2201 CC	63,76	+10 - -40	45	203	42	28	2,5
HEX5 / 4	HEX 2000 CS	75,83	0 - -40	38	177	42	28	3,5
	HEX 2500 CC	75,83	+10 - -40	48	203	54	28	3,5
	HEX 2500 CS	85,01	0 - -40	45	203	54	28	3,5
	HEX 3000 CC	85,01	+10 - -40	56	224	54	28	3,5
	HEX 2700 CS	92,25	0 - -40	48	203	54	35	3,5
	HEX 3200 CC	92,25	+10 - -40	60	260	54	35	3,5
	HEX 2900 CS	102,35	0 - -40	56	245	54	35	3,5
	HEX 3400 CC	102,35	+10 - -40	60	260	54	35	3,5
HEX6 / 6	HEX 3000 CS	113,74	0 - -40	60	245	54	35	3,5
	HEX 3500 CC	113,74	+10 - -40	66	260	54	35	3,5
	HEX 3500 CS	127,52	0 - -40	60	245	54	35	3,5
	HEX 4000 CC	127,52	+10 - -40	75	290	54	35	3,5
	HEX 4000 CS	138,37	0 - -40	66	260	54	42	3,5
	HEX 4500 CC	138,37	+10 - -40	84	323	54	42	3,5
	HEX 4500 CS	153,52	0 - -40	75	290	54	42	3,5
	HEX 5000 CC	153,52	+10 - -40	93	358	54	42	3,5
HEX7 / 8	HEX 5000 CS	164,30	0 - -40	90	367	66	42	8,5
	HEX 5500 CC	164,30	+10--40	105	455	66	42	8,5
	HEX 5500 CS	184,19	0 - -40	105	455	80	42	8,5
	HEX 6000 CC	184,19	+10--40	120	544	80	42	8,5
	HEX 6000 CS	199,86	0 - -40	105	455	80	42	8,5
	HEX 7500 CC	199,86	+10--40	148	584	80	42	8,5
	HEX 7501 CS	221,75	0 - -40	120	544	80	54	8,5
	HEX 8001 CC	221,75	+10--40	148	584	80	54	8,5
	HEX 8000 CS	244,78	0 - -40	120	544	80	54	8,5
	HEX 9000 CC	244,78	+10--40	148	584	80	54	8,5



KOMPRESÖRLER

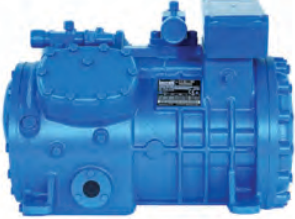

YARI HERMETİK

	MODEL	HP	ÇALIŞMA ARALIĞI (LİMİT)	BAĞLANTI (mm)	PİSTON HACMI	SİLİNDİR SAYISI
 	SEMİ HERMETİK PİSTONLU KOMPRESÖRLER - A,B,D,Q,S SERİSİ					
	A 0.5 4 Y	0,5	+7,5 / -40	5/8" - 1/2"	3,95	2
	A 0.5 5 Y	0,5	-5 / -45	5/8" - 1/2"	4,93	2
	A 0.7 5 Y	0,75	+5 / -45	5/8" - 1/2"	4,93	2
	A 0.7 6 Y	0,75	-5 / -45	5/8" - 1/2"	5,47	2
	A 1 6 Y	1	+7,5 / -45	5/8" - 1/2"	5,47	2
	A 1 7 Y	1	-5 / -45	5/8" - 1/2"	6,91	2
	A 1.5 7 Y	1,5	+7,5 / -40	5/8" - 1/2"	6,91	2
	A 1.5 8 Y	1,5	+5 / -45	5/8" - 1/2"	7,65	2
	B 1.5 9.1 Y	1,5	+7,5 / -45	5/8" - 1/2"	8,96	2
	B 1.5 10.1 Y	1,5	-5 / -45	5/8" - 1/2"	9,88	2
	B 2 10.1 Y	2	+7,5 / -40	3/4" - 5/8"	9,88	2
	D 2 11.1 Y	2	+7,5 / -40	7/8" - 5/8"	11,26	2
	D 2 13.1 Y	2	-5 / -45	7/8" - 5/8"	13,15	2
	D 2 15.1 Y	2	-5 / -45	7/8" - 5/8"	15,36	2
	D 3 13.1 Y	3	+7,5 / -30	1 1/8" - 5/8"	13,15	2
	D 3 15.1 Y	3	+5 / -30	1 1/8" - 5/8"	15,36	2
	D 3 16.1 Y	3	-5 / -45	1 1/8" - 5/8"	16,40	2
	D 3 18.1 Y	3	-10 / -45	1 1/8" - 5/8"	17,93	2
	D 3 19.1 Y	3	-15 / -45	1 1/8" - 5/8"	19,12	2
	D 4 16.1 Y	4	+7,5 / -30	1 1/8" - 3/4"	16,40	2
	D 4 18.1 Y	4	+5 / -30	1 1/8" - 3/4"	17,93	2
	D 4 19.1 Y	4	-5 / -45	1 1/8" - 3/4"	19,12	2

	SEMİ HERMETİK PİSTONLU KOMPRESÖRLER - A,B,D,Q,S SERİSİ					
Q 4 20.1 Y	4	-5 / -45	1 1/8" - 3/4"	19,77	4	
Q 4 21.1 Y	4	-5 / -45	1 1/8" - 3/4"	21,18	4	
Q 4 24.1 Y	4	-5 / -45	1 1/8" - 3/4"	23,60	4	
Q 4 25.1 Y	4	-5 / -45	1 1/8" - 3/4"	24,69	4	
Q 5 21.1 Y	5	+7,5 / -30	1 1/8" - 3/4"	21,18	4	
Q 5 24.1 Y	5	+5 / -30	1 1/8" - 7/8"	23,60	4	
Q 5 25.1 Y	5	+5 / -40	1 1/8" - 7/8"	24,69	4	
Q 5 28.1 Y	5	-5 / -45	1 3/8" - 7/8"	28,02	4	
Q 5 33.1 Y	5	-5 / -45	1 3/8" - 1 1/8"	32,66	4	
Q 7 25.1 Y	7,5	+7,5 / -40	1 1/8" - 7/8"	24,69	4	
Q 7 28.1 Y	7,5	+5 / -30	1 3/8" - 1 1/8"	28,02	4	
Q 7 33.1 Y	7,5	+5 / -30	1 3/8" - 1 1/8"	32,66	4	
Q 7 36.1 Y	7,5	-5 / -45	1 3/8" - 1 1/8"	35,86	4	
S 8 42 Y	8	-5 / -45	1 3/8" - 1 1/8"	41,32	4	
S 10 52 Y	10	-5 / -45	1 3/8" - 1 1/8"	51,50	4	
S 12 42 Y	12	+5 / -30	1 3/8" - 1 1/8"	41,32	4	
S 15 52 Y	15	+7,5 / -40	1 5/8" - 1 1/8"	51,50	4	

KOMPRESÖRLER



YARI HERMETİK

	MODEL	HP	ÇALIŞMA ARALIĞI (LİMİT)	BAĞLANTI (mm)	PİSTON HACMI	SİLİNDİR SAYISI
	SEMİ HERMETİK PİSTONLU KOMPRESÖRLER - A,B,D,Q,S SERİSİ					
	S 15 56 Y	15	-5 / -45	1 5/8" - 1 1/8"	56,00	4
		15	-5 / -45	1 5/8" - 1 1/8"	59,00	4
	V 15 59 Y	15	-5 / -45	1 5/8" - 1 1/8"	70,77	4
	V 15 71 Y	20	+7,5 / -40	1 5/8" - 1 1/8"	56,00	4
	S 20 56 Y	20	+7,5 / -40	1 5/8" - 1 1/8"	59,00	4
	V 20 59 Y					

	SEMİ HERMETİK PİSTONLU KOMPRESÖRLER - V,Z,W SERİSİ					
	V 20 84 Y	20	-5 / -45	1 5/8" - 1 1/8"	83,81	4
	V 25 71 Y	25	+7,5 / -40	2 1/8" - 1 3/8"	70,77	4
	V 25 93 Y	25	-5 / -45	2 1/8" - 1 3/8"	93,05	4
	V 25 103 Y	25	-5 / -45	2 1/8" - 1 3/8"	102,90	4
	Z 25 106 Y	25	-5 / -45	2 1/8" - 1 3/8"	106,16	6
	V 30 84 Y	30	+7,5 / -40	2 1/8" - 1 3/8"	83,31	4
	Z 30 126 Y	30	-5 / -45	2 1/8" - 1 3/8"	125,72	6
	V 32 93 Y	32	+7,5 / -40	2 1/8" - 1 3/8"	93,05	4
	V 35 103 Y	35	+7,5 / -40	2 1/8" - 1 3/8"	102,90	4
	Z 35 106 Y	35	+7,5 / -40	2 1/8" - 1 3/8"	106,16	6
	Z 40 126 Y	40	+7,5 / -40	2 5/8" - 1 5/8"	125,72	6
	Z 40 140 Y	40	-5 / -45	2 5/8" - 1 5/8"	140,00	6
	W 40 142 Y	40	0 / -45	2 5/8" - 1 5/8"	141,50	8
	Z 40 154 Y	40	-5 / -45	2 5/8" - 1 5/8"	154,38	6
	Z 40 168 Y	40	-5 / -45	2 5/8" - 1 5/8"	168,00	6
	W 40 168 Y	40	-5 / -45	2 5/8" - 1 5/8"	167,60	8
	Z 50 140 Y	50	+7,5 / -40	2 5/8" - 1 5/8"	140,00	6
	Z 50 154 Y	50	+7,5 / -40	2 5/8" - 1 5/8"	154,38	6
	Z 50 168 Y	50	+7,5 / -40	2 5/8" - 1 5/8"	168,00	6
	W 50 168 Y	50	+7,5 / -30	3 1/8" - 1 5/8"	167,60	8
	Z 50 185 Y	50	-5 / -45	2 5/8" - 1 5/8"	185,00	6
	W 50 187 Y	50	-5 / -45	3 1/8" - 1 5/8"	186,10	8
	W 60 187 Y	60	+7,5 / -30	3 1/8" - 1 5/8"	186,10	8
	W 60 206 Y	60	-5 / -45	3 1/8" - 2 1/8"	205,80	8
	W 70 206 Y	70	+7,5 / -30	3 1/8" - 2 1/8"	205,80	8
	W 70 228 Y	70	-5 / -45	3 1/8" - 2 1/8"	227,77	8
	W 75 228 Y	75	+7,5 / -30	3 1/8" - 2 1/8"	227,77	8
	W 75 240 Y	75	-5 / -45	3 1/8" - 2 1/8"	239,02	8
	W 80 240 Y	80	+7,5 / -30	3 1/8" - 2 1/8"	239,02	8

KOMPRESÖRLER

YARI HERMETİK

	MODEL	HP	ÇALIŞMA ARALIĞI (LİMİT)	BAĞLANTI (mm)	PİSTON HACMİ	SİLİNDİR SAYISI
	SEMİ HERMETİK ÇİFT KADEMELİ KOMPRESÖRLER - S,Y,Z SERİSİ					
	S 5 26-16 Y	5,5	-25 / -70	1 3/8" - 7/8"	S 5 26-16 Y	5,5
	S 7 27-19 Y	7,5	-25 / -70	1 3/8" - 7/8"	S 7 27-19 Y	7,5
	2V 10 42-29 Y	10	-25 / -70	1 3/8" - 11/8"	2V 10 42-29 Y	10
	2Z 15 60-30 Y	15	-25 / -70	1 5/8" - 1 3/8"	2Z 15 60-30 Y	15
	2Z 20 72-36 Y	20	-25 / -70	1 5/8" - 1 3/8"	2Z 20 72-36 Y	20
	2Z 25 84-42 Y	25	-25 / -70	1 5/8" - 1 3/8"	2Z 25 84-42 Y	25
	2Z 30 102-51 Y	30	-25 / -70	1 5/8" - 1 1/8"	2Z 30 102-51 Y	30
	2Z 35 112-56 Y	35	-25 / -70	1 5/8" - 1 1/8"	2Z 35 112-56 Y	35
	2Z 40 123-62 Y	40	-25 / -70	1 5/8" - 2 1/8"	2Z 40 123-62 Y	40

SOĞUTUCU AKIŞKANLAR

**R134a**

Tekrar Doldurulabilir Tüp

**R404a**

Tekrar Doldurulabilir Tüp

**R410a**

Tekrar Doldurulabilir Tüp

**R407c**

Tekrar Doldurulabilir Tüp

**R32**

Tekrar Doldurulabilir Tüp

**1234yf**

Tekrar Doldurulabilir Tüp

**R600a**

400 Gr E-Gas

**R600a**

400 Gr UISZL Gas

SOĞUTUCU AKIŞKANLAR

**R600a**

420 Gr Settela Gas

**R600a**

420 Gr Nevada Gas

**R600a**

420 GR D Gas

**R290**

370 Gr E-Gas

**R290**

370 Gr Nevada Gas

**R134a**

800 Gr Tek Kullanımlık Tüp

**R134a**

13,6 Kg Tek Kullanımlık Tüp

**R404a**

9,8 Kg Tek Kullanımlık Tüp

**R404a**

10,9 Kg Tek Kullanımlık Tüp

**R407c**

11,35 Kg Tek Kullanımlık Tüp

**R32**

7 Kg Tek Kullanımlık Tüp

**R410a**

11,35 Kg Tek Kullanımlık Tüp

KONDENSERLER



Kod	Kapasite Δ T: 15 °C	Fan Bilgileri		
		Fan Devr	Çap	Yüzey Alan
		Watt	d/dak	mm
AK SERİSİ				
AK 1/5	478	-	-	1,44
AK 1/5 D	478	1800	200 X 1	1,44
AK 1/4	662	-	-	2,01
AK 1/4 D	662	1800	200 X 1	2,01
AK 1/3	986	-	-	2,47
AK 1/3 D	986	1400	250 X 1	2,47
AK 1/3 ÇD	1359	1800	200 X 2	3,37
AK 1/2	1417	-	-	3,70
AK 1/2 D	1417	1400	250 X 1	3,70
AK 1/2 ÇD	1769	1800	200 X 2	4,92
AK 3/4	1729	-	-	4,94
AK 3/4 D	1729	1400	250 X 1	4,94
AK 3/4 D 1X300	2206	1320	300*1	4,74
AK 3/4 ÇD	1893	1800	200 * 2	4,97
AK 1 HP	2685	-	-	6,32
AK 1 HP D	2685	1320	300 X 1	6,32
AK 1 HP ÇD	2296	1800	200 X 2	6,56
AK 1,5 HP	2783	1320	-	7,41
AK 1,5 HP D	2783	1320	-	7,41
AK 1,5 HP ÇD	2839	1400	250 X 2	7,54
AK 2 HP	2991	1320	-	8,53
AK 2 HP D	2991	1320	300 X 1	8,53
AK 2 HP ÇD	3077	1400	250 X 2	8,67
AK 10 D	4365	1340	300 X 1	9,81
AK 10 ÇD	3441	1400	250 X 2	10,04
AK 12 D	4753	1340	350 X 1	11,44
AK 12 ÇD	3721	1400	250 X 2	11,93
AK 15 D	6635	1430	400 X 1	15,65

KONDENSERLER



azak
soğutma



Kod	Kapasite Δ T: 15 °C	Fan Bilgileri		
		Fan Devr	Çap	Yüzey Alan
		d/dak	mm	m ²
AK 20 ÇD	9168	1340	350 X 2	19,5
AK 25 D	10388	1400	500 X 1	24,4
AK 25 D V2	10497	1400	500 X 1	24,5
AK 25 ÇD	10431	1340	350 X 2	26,1
AK 30 D	14215	1360	500 X 1	29,6
AK 30 D V2	14164	1360	500 X 1	29,6
AK 30 ÇD	10779	1340	350 X 2	28,3
AK 35 D	15918	1360	500 X 1	35,3
AK 35 ÇD	14366	1430	400 X 2	35,3
AK 40 D	17465	1360	500 X 1	39,4
AK 40 ÇD	15497	1430	400 X 2	38,8
AK 50 D	19200	1360	500 X 1	49,3
AK 50 ÇD	21260	1400	500 X 2	48,9
AK 60 ÇD	28431	1360	500 X 2	59,2
AK 70 ÇD	31834	1360	500 X 2	70,6
AK 80 ÇD	33337	1360	500 X 2	78,9
AK 90 ÇD	34676	1360	500 X 2	88,3
AK 90 ÜD	42646	1360	500 X 3	88,7
AK 100 ÇD	38081	1360	500 X 2	98,6
AK 100 ÜD	43332	1360	500 X 3	97,8
AK 105 ÇD	42708	850	630 X 2	104,3
AK 110 ÜD	47813	1360	500 X 3	109,24
AK 115 ÇD	44246	850	630 X 2	113,0
AK 120 ÇD	40221	1360	500 X 2	118,3
AK 120 ÜD	49749	1360	630 X 2	118,3
AK 120 DD	56862	1360	500 X 4	118,3
AK 135 ÜD	52994	1360	500 X 3	132,4
AK 135 DD	62416	1360	500 X 4	135,6

KONDENSERLER

azak
air conditioning



Kod	Kapasite Δ T: 15 °C	Fan Bilgileri		
		Fan Devr	Çap	Yüzey Alan
		Watt	d/dak	mm
AK 160 DD	66204	1360	500 x 4	157,7
AK 170 ÇD	51544	850	630 X 2	169,5
AK 170 ÜD	66369	850	630 X 3	169,5
AK 175 DD	6532	1360	500 x 4	176,6
AK 200 ÜD	69596	850	630 X 3	195,7
AK 200 DD	76343	1360	500 x 4	197,2
AK 210 DD	85415	850	630 X 4	208,7
AK 240 DD	80441	1360	500 x 4	236,6
AK 250 ÜD	78276	850	630 X 3	254,3
AK 260 DD	96571	850	630 X 4	260,9
AK 270 AD	106403	1360	500 x 6	264,8
AK 315 DD	101083	850	630 X 4	313,0
AK 315 AD	128123	850	630 X 6	313,0

KONDENSERLER

azak
SOLUŞUM VE SOĞUTMA



Kod	Kapasite ▲ T: 15 °C	Fan Bilgileri		Yüzey Alan m ²
		Fan Devr	Çap	
	Watt	d/dak	mm	m ²
WK 1 FANLI 7-35				
WK 7-130	2132	1320	300x1	6,9
WK 7-135	2776	1340	350x1	
WK 10-130	2244	910	300x1	10,42
	3192	1320		
WK 10-135	4583	1340	350x1	14,69
	3601	910		
WK 15-135	5830	1340	350x1	14,69
	4511	910		
WK 15-140	6568	1430	400x1	20,22
	5581	940		
WK 20-140	7570	1430	400x1	20,2201
	6278	940		
WK 20-145	9038	1300	450x1	24,09355
	7953	900		
WK 25-140	8391	1430	400x1	34,81
	6928	870		
WK 25-145	9570	1300	450x1	34,81
	8379	900		
WK 30-145	11322	1300	450x1	39,6
	9590	900		
WK 35-145	12763	1300	450x1	39,6
	10792	900		
WK 35-150	16155	1360	500x1	39,6
	12138	865		
WK 40-150	16816	1360	500x1	39,6
	12523	865		

KONDENSERLER

azak
SOLUCİSİTEKLERİ



Kod	Kapasite ▲ T: 15 °C	Fan Bilgileri		Yüzey Alan m ²
		Fan Devr	Çap	
		Watt	d/dak	
WK 2 FAZLI 40-70				
WK 40-240	15508	1430	400x2	39,19
	12876	870		
WK 40-245	17667	1300	450x2	39,19
	15555	900		
WK 45-240	16396	1430	400x2	44,56
	13560	870		
WK 45-245	19283	1300	450x2	44,56
	16889	900		
WK 50-240	17879	1430	400x2	48,03
	14734	870		
WK 50-245	21183	1300	450x2	48,03
	18306	900		
WK 55-245	22595	1300	450x2	53,3
	19413	900		
WK 60-245	24080	1300	450x2	60,51
	20601	900		
WK 60-250	29788	1360	500x2	60,51
	22669	865		
WK 65-245	24987	1300	450x2	64,94
	21330	900		
WK 65-250	31160	1360	500x2	64,94
	23602	865		
WK 70-245	25972	1300	450x2	70,11
	22050	900		
WK 70-250	32666	1360	500x2	70,11
	24589	865		

KONDENSERLER



Model	Yüzey	Boru Hacmi	Kapasite	Fanlar	
	m ²			dm ³	Adet
MKK SERİSİ					
MKK 1/5	1,31	0,20	400	0	200
MKK 1/4	1,98	0,20	610	0	200
MKK 1/3	2,50	0,30	960	0	250
MKK 1/2	3,75	0,50	1.340	0	250
MKK 3/4	4,99	0,60	1.650	0	250
MKK 1HP	6,25	0,80	2.920	0	300
MKK 1/5 20110	1,31	0,20	400	1	200
MKK 1/4 20111	1,98	0,20	610	1	200
MKK 1/3 25112	2,50	0,30	960	1	250
MKK 1/2 25113	3,75	0,50	1.340	1	250
MKK 3/4 25114	4,99	0,60	1.650	1	250
MKK 1HP 30115	6,25	0,80	2.920	1	300
MKK 7,5 30117	7,78	0,70	3.090	1	300
MKK 8,5 30118	8,45	0,90	3.410	1	300
MKK 10 30119	10,14	1,10	3.953	1	300
MKK 12 35120	12,04	1,40	5.260	1	350
MKK 14 35121	13,94	1,60	5.878	1	350
MKK 16 35122	15,76	1,60	6.201	1	350
MKK 1/3 20212	3,23	0,40	1.210	2	200
MKK 1/2 20213	4,79	0,50	1.570	2	200
MKK 3/4 20214	4,85	0,60	1.720	2	200
MKK 1HP 20215	6,47	0,70	2.060	2	200
MKK 7,5 25217	7,44	0,80	2.770	2	250
MKK 8,5 25218	8,45	0,80	2.920	2	250
MKK 10 25210	10,56	1,10	3.390	2	250
MKK 12 25212	11,44	1,20	3.570	2	250
MKK 14 30214	13,73	1,50	6.280	2	300
MKK 16 30216	15,83	2,00	6.770	2	300

KONDENSERLER



Model	Yüzey m ²	Boru Hacmi dm ³	Kapasite $\Delta T: 15^\circ C$		Fanlar	
			"S" 1/ 230V AC 50Hz 1400 rpm"	"L" 1/ 230V AC 50Hz 900 rpm"	Adet	Çap mm
			W	W		
KK SERİSİ						
KK11 30111	11,05	1,0	3.569	3.112	1	300
KK15 30112	14,74	1,3	4.127	3.413	1	300
KK18 30113	18,42	1,7	4.415	-	1	300
KK18 35111	18,01	1,6	6.575	4.956	1	350
KK24 35112	24,02	2,2	7.683	5.612	1	350
KK30 35113	30,02	2,7	8.221	5.800	1	350
KK18 40111	18,01	1,6	7.398	5.993	1	400
KK24 40112	24,02	2,2	8.652	6.837	1	400
KK30 40113	30,02	2,7	9.316	7.048	1	400
KK27 40111	26,61	2,4	9.079	7.361	1	400
KK35 40112	35,48	3,2	10.759	8.523	1	400
KK44 40113	44,35	4,0	11.754	9.091	1	400
KK27 45111	26,61	2,4	10.495	9.051	1	450
KK31 45111	31,46	2,4	11.403	9.719	1	450
KK35 45112	35,48	3,2	12.498	10.438	1	450
KK42 45112	41,94	3,2	13.294	10.960	1	450
KK45 45113	44,35	4,0	13.706	11.186	1	450
KK27 50111	26,61	2,4	13.167	9.844	1	500
KK32 50111	31,46	2,4	14.325	10.558	1	500
KK36 50112	35,48	3,2	15.422	11.142	1	500
KK42 50112	41,94	3,2	16.436	-	1	500
KK45 50113	44,35	4,0	17.035	-	1	500
KK22 30211	22,11	2,00	7.138	6.224	2	300
KK30 30212	29,48	2,60	8.254	6.826	2	300
KK37 30213	36,84	3,40	8.830	-	2	300
KK36 35211	36,02	3,20	13.150	9.912	2	350
KK48 35212	48,04	4,40	15.366	11.224	2	350
KK60 35213	60,04	5,40	16.442	11.600	2	350

KONDENSERLER



Model	Yüzey m ²	Boru Hacmi dm ³	Kapasite ▲ T: 15 °C		Fanlar	
			"S" 1/ 230V AC 50Hz 1400 rpm"	"L" 1/ 230V AC 50Hz 900 rpm"	Adet	Çap
			W	W		mm
KK SERİSİ						
KK36 40211	36,02	3,20	14.796	11.986	2	400
KK43 40211	42,59	3,20	14.837	12.014	2	400
KK48 40212	48,04	4,40	17.304	13.674	2	400
KK57 40212	56,79	4,40	18.853	14.737	2	400
KK60 40213	60,04	5,40	18.632	14.096	2	400
KK53 40211	53,22	4,80	18.158	14.722	2	400
KK71 40212	70,96	6,40	21.518	17.046	2	400
KK89 40213	88,70	8,00	23.508	18.182	2	400
KK53 45211	53,22	4,80	20.990	18.102	2	450
KK63 45211	62,92	4,80	22.806	19.438	2	450
KK71 45212	70,96	6,40	24.996	20.876	2	450
KK84 45212	83,88	6,40	26.588	21.920	2	450
KK89 45213	88,70	8,00	27.412	22.372	2	450
KK53 50211	53,22	4,80	26.334	19.688	2	500
KK63 50211	62,92	4,80	28.650	21.116	2	500
KK71 50212	70,96	6,40	30.844	22.284	2	500
KK84 50212	83,88	6,40	32.872	-	2	500
KK89 50213	88,70	8,00	34.070	-	2	500
KK80 40311	79,83	7,20	22.194	17.979	3	400
KK106 40312	106,45	9,60	25.956	20.511	3	400
KK133 40313	133,06	12,00	27.948	21.144	3	400
KK80 45311	79,83	7,20	31.485	27.153	3	450
KK94 45311	94,38	7,20	34.209	29.157	3	450
KK106 45312	106,45	9,60	37.494	31.314	3	450
KK126 45312	125,82	9,60	39.882	32.880	3	450
KK133 45313	133,06	12,00	41.118	33.558	3	450
KK80 50311	79,83	7,20	39.501	29.532	3	500
KK94 50311	94,38	7,20	42.975	31.674	3	500

KONDENSERLER



Model	Yüzey m ²	Boru Hacmi dm ³	Kapasite ▲ T: 15 °C		Fanlar	
			"S" 1/ 230V AC 50Hz 1400 rpm"	"L" 1/ 230V AC 50Hz 900 rpm"	Adet	Çap mm
			W	W		
KK SERİSİ						
KK106 50312	106,45	9,60	46.266	33.426	3	500
KK126 50312	125,82	9,60	49.308	-	3	500
KK133 50313	133,06	12,00	51.105	-	3	500
KK106 40221	106,45	9,50	29.592	23.972	4	400
KK142 40222	141,93	12,80	34.608	27.348	4	400
KK177 40223	177,41	16,00	37.264	28.192	4	400
KK106 45221	106,45	9,50	41.980	36.204	4	450
KK126 45221	125,84	9,50	45.612	38.876	4	450
KK142 45222	141,93	12,80	49.992	41.752	4	450
KK168 45222	167,76	12,80	53.176	43.840	4	450
KK177 45223	177,41	16,00	54.824	44.744	4	450
KK106 50221	106,45	9,50	52.668	39.376	4	500
KK126 50221	125,84	9,50	57.300	42.232	4	500
KK142 50222	141,93	12,80	61.688	44.568	4	500
KK168 50222	167,76	12,80	65.744	-	4	500
KK177 50223	177,41	16,00	68.140	-	4	500

KONDENSERLER



Model	Yüzey m ²	Boru Hacmi dm ³	Kapasite ▲ T: 15 °C		Fanlar	
			"S 1/ 230V AC 50Hz 1400 rpm"	"L 1/ 230V AC 50Hz 900 rpm"	Adet	Çap
			W	W		mm
BZBOX SERİSİ						
BZBOX 07	6,19	0,80	3.120	2.700	1	300
BZBOX 10	11,92	1,20	4.850	3.950	1	300
BZBOX 15	12,08	1,50	6.170	5.180	1	350
BZBOX 20NR	16,67	1,80	8.580	7.410	1	400
BZBOX 30NR	20,74	2,70	10.870	8.870	1	450
BZBOX 40NR	24,75	3,20	11.800	9.600	1	450
BZBOX 50NR	37,21	4,70	18.350	16.000	2	400
BZBOX 60NR	38,20	4,80	20.660	16.960	2	450
BZBOX 70NR	46,48	5,80	22.810	18.710	2	450
BZBOX 20TR	23,82	2,60	10.730	8.750	1	400
BZBOX 30TR	29,67	3,80	13.490	10.690	1	450
BZBOX 40TR	36,48	4,70	14.670	11.730	1	450
BZBOX 50TR	53,98	6,60	23.500	19.280	2	400
BZBOX 60TR	55,45	6,80	26.010	20.530	2	450
BZBOX 70TR	68,69	8,60	28.860	22.910	2	450

SOĞUTUCULAR

AEY SOĞUK ODA



1 FANLI 6 mm LAMEL

Kod	AEY 130-36	AEY 130-46	AEY 130-56	AEY 135-36	AEY 135-46	AEY 135-56	AEY 135-66	AEY 140-46	AEY 140-56	AEY 140-66	
Kapasite	SC 1	1964	2462	2801	3090	3782	4523	5071	4761	5592	6169
	SC 2	1411	1760	1993	2207	2735	3257	3642	3429	4010	4407
	SC 3	1113	1307	1412	1599	2201	2507	2708	2659	2964	3127
	SC 4	-	-	-	-	-	-	-	-	-	-
Fan Bilgileri	Çap 300x1			350x1				400x1			
Batarya Bilgileri	Yüzey Alanı m ²	5,5	7,3	9,1	7,6	10,1	12,6	15,2	12,1	15,1	18,2

Kod	AEY 145-36	AEY 145-46	AEY 145-56	AEY 145-66	AEY 150-36	AEY 150-46	AEY 150-56	AEY 150-66	AEY 150-56 v2	AEY 150-66 v2"	
Kapasite	SC 1	5659	7107	8354	9420	6579	8288	9775	11058	12355	14008
	SC 2	4090	5139	6046	6825	4784	6031	7118	8059	8889	10088
	SC 3	3328	4176	4911	5493	3906	4925	5817	6616	6886	7844
	SC 4	-	-	-	-	-	-	-	-	-	-
Fan Bilgileri	Çap 450x1				500x1						
Batarya Bilgileri	Yüzey Alanı m ²	14,3	19,0	23,8	28,6	14,3	19,0	23,8	28,6	30,9	37,1

2 FANLI 6 mm LAMEL

Kod	AEY 230 36	AEY 230 46	AEY 230 56	AEY 235 36	AEY 235 46	AEY 235 56	AEY 235 66	AEY 240 46	AEY 240 56	AEY 240 66	
Kapasite	SC 1	3885	4964	5740	6274	7786	9131	10227	9672	11329	12710
	SC 2	2794	3551	4096	4493	5595	6540	7356	6923	8127	9144
	SC 3	2247	2715	3228	3542	4342	5128	5634	5432	6405	7069
	SC 4	1796	2212	2597	2862	3538	4205	4589	4450	5234	5770
Fan Bilgileri	Çap 300x2			350x2				400x2			
Batarya Bilgileri	Yüzey Alanı m ²	11,0	14,7	18,3	15,2	20,2	25,3	30,4	24,2	30,3	36,3

SOĞUTUCULAR

AEY SOĞUK ODA



2 FANLI 6 mm LAMEL

Kod	AEY 245 36	AEY 245 46	AEY 245 56	AEY 245 66	AEY 250 36	AEY 250 46	AEY 250 56	AEY 250 66	AEY 250 56 V2	AEY 250 66 V2	
Kapasite	SC 1	11866	15022	17185	19775	13744	17441	20107	23180	24912	28444
	SC 2	8489	10735	12353	14173	9891	12544	14553	16717	17886	20352
	SC 3	6491	8147	9883	10964	7839	9833	11640	12889	13866	15190
	SC 4	5263	6610	8043	8955	6457	8023	9534	10448	11293	12155
Fan Bilgileri	Çap	450x2				500x2					
Batarya Bilgileri	Yüzey Alanı m ²	28,6	38,1	47,7	57,2	28,6	38,1	47,7	57,2	61,9	74,2

3 FANLI 6 mm LAMEL

Kod	AEY 330 36	AEY 330 46	AEY 330 56	AEY 335 36	AEY 335 46	AEY 335 56	AEY 335 66	AEY 340 46	AEY 340 56	AEY 340 66	
Kapasite	SC 1	6073	7490	8698	9471	11813	13780	15409	13820	16175	18156
	SC 2	4332	5359	6212	6785	8473	9899	11086	9902	11610	13036
	SC 3	3226	4121	4855	5125	6435	7567	8528	7828	9005	9766
	SC 4	2608	3365	3941	4104	5224	6158	6959	6437	7345	7917
Fan Bilgileri	Çap	300x3			350x3			400x3			
Batarya Bilgileri	Yüzey Alanı m ²	16,5	22,0	27,5	22,8	30,4	38,0	45,5	34,1	42,6	51,1

Kod	AEY 345 36	AEY 345 46	AEY 345 56	AEY 345 66	AEY 350 36	AEY 350 46	AEY 350 56	AEY 350 66	AEY 350 56 V2	AEY 350 66 V2	
Kapasite	SC 1	17810	22359	26255	29555	20674	26049	30714	34733	37598	42697
	SC 2	12755	16015	18819	21214	14891	18778	22163	25080	26897	30754
	SC 3	9790	12334	14556	16467	11364	14399	17081	19427	19965	22771
	SC 4	7952	10042	11882	13481	9078	11552	13757	15834	15926	18221
Fan Bilgileri	Çap	450x3				500x3					
Batarya Bilgileri	Yüzey Alanı m ²	42,9	57,2	71,5	85,8	42,9	57,2	71,5	85,8	92,8	111,4

SOĞUTUCULAR

AEY SOĞUK ODA



4 FANLI 6 mm LAMEL

Kod	AEY 430 36	AEY 430 46	AEY 430 56	AEY 435 36	AEY 435 46	AEY 435 56	AEY 435 66	AEY 440 46	AEY 440 56	AEY 440 66	
Kapasite	SC 1	8095	9998	11577	11981	15669	18443	20666	19441	22826	25491
	SC 2	5789	7153	8302	8670	11264	13218	14841	13930	16367	18318
	SC 3	4438	5508	6423	7130	8796	9897	11141	10461	12217	13936
	SC 4	3615	4500	5262	5781	7189	8040	9044	8375	9793	11348
Fan Bilgileri	Çap	300x4			350x4			400x4			
Batarya Bilgileri	Yüzey Alanı m ²	22,0	29,3	36,7	30,4	40,5	50,6	60,7	48,4	60,5	72,6

Kod	AEY 445 36	AEY 445 46	AEY 445 56	AEY 445 66	AEY 450 36	AEY 450 46	AEY 450 56	AEY 450 66	AEY 450 56 V2	AEY 450 66 V2	
Kapasite	SC 1	23793	30087	35173	39462	27634	35053	41162	46398	50191	56935
	SC 2	17042	21531	25200	28326	19908	25233	29689	33506	35926	40805
	SC 3	13104	16439	19451	22020	15227	19152	22822	26004	26830	30652
	SC 4	10650	13382	15876	18038	12983	15315	18370	21208	21451	24608
Fan Bilgileri	Çap	450x4				500x4					
Batarya Bilgileri	Yüzey Alanı m ²	57,2	76,3	95,3	114,4	57,2	76,3	95,3	114,4	123,7	148,5

1 FANLI 8 mm LAMEL

Kod	AEY 130-38	AEY 130-48	AEY 130-58	AEY 135-38	AEY 135-48	AEY 135-58	AEY 135-68	AEY 140-48	AEY 140-58	AEY 140-68	
Kapasite	SC 1	1652	2122	2316	2644	3209	3913	4475	4060	4872	5444
	SC 2	1185	1515	1592	1888	2316	2813	3208	2920	3490	3922
	SC 3	938	1153	1279	1401	1863	2203	2421	2308	2627	3109
	SC 4	743	925	1035	1126	1478	1776	1961	1870	2125	2502
Fan Bilgileri	Çap	300x1			350x1			400x1			
Batarya Bilgileri	Yüzey Alanı m ²	4,25	5,66	7,05	5,86	7,82	9,77	11,72	9,34	11,68	14,02

SOĞUTUCULAR

AEY SOĞUK ODA



1 FANLI 8 mm LAMEL

Kod	AEY 145-38	AEY 145-48	AEY 145-58	AEY 145-68	AEY 150-38	AEY 150-48	AEY 150-58	AEY 150-68	AEY 150-48 V2	AEY 150-68 V2	
Kapasite	SC 1	4993	6136	7402	8581	5513	7014	8352	9614	12121	
	SC 2	3567	4401	5312	6142	4001	5092	6066	6966	8714	
	SC 3	2704	3469	4208	4705	3309	4206	5007	5629	6890	
	SC 4	2188	2814	3388	3830	2686	3389	3995	4578	4067	5602
Fan Bilgileri	Çap	450x1				500x1					
Batarya Bilgileri	Yüzey Alanı m ²	11,04	14,62	18,41	22,1	11,04	14,73	18,41	21,93	19,1	28,67

2 FANLI 8 mm LAMEL

Kod	AEY 230 38	AEY 230 48	AEY 230 58	AEY 235 38	AEY 235 48	AEY 235 58	AEY 235 68	AEY 240 48	AEY 240 58	AEY 240 68	
Kapasite	SC 1	3260	4250	4875	5324	6640	7965	8978	8285	11042	
	SC 2	2341	3038	3496	3810	4767	5697	6444	5931	7939	
	SC 3	1845	2362	2727	2915	3762	4297	5017	4652	6237	
	SC 4	1472	1898	2186	2364	3050	3484	4061	3744	4409	5065
Fan Bilgileri	Çap	300x2			350x2			400x2			
Batarya Bilgileri	Yüzey Alanı m ²	8,5	11,3	14,2	11,7	15,6	19,5	23,5	18,7	23,4	28,0

Kod	AEY 245 38	AEY 245 48	AEY 245 58	AEY 245 68	AEY 250 38	AEY 250 48	AEY 250 58	AEY 250 68	AEY 250 58 V2	AEY 250 68 V2	
Kapasite	SC 1	9965	12749	14623	17085	11635	14915	17172	20101	21258	24676
	SC 2	7126	9109	10502	12240	8370	10727	12416	14493	15253	17664
	SC 3	5534	7022	8423	9612	6484	8435	10074	11332	11975	13142
	SC 4	4507	5718	6697	7770	5261	6904	8219	9250	9789	10887
Fan Bilgileri	Çap	450x2				500x2					
Batarya Bilgileri	Yüzey Alanı m ²	22,1	29,5	36,8	44,2	22,1	29,5	36,8	44,2	47,8	57,3

SOĞUTUCULAR

AEY SOĞUK ODA



3 FANLI 8 mm LAMEL

Kod	AEY 330 38	AEY 330 48	AEY 330 58	AEY 335 38	AEY 335 48	AEY 335 58	AEY 335 68	AEY 340 48	AEY 340 58	AEY 340 68	
Kapasite	SC 1	5161	6403	7604	8024	10117	11941	13627	12484	14701	16715
	SC 2	3678	4578	5423	5743	7245	8559	9754	8922	10547	12005
	SC 3	2789	3575	4075	4414	5586	6624	7579	7008	8172	9297
	SC 4	2263	2883	3306	3594	4549	5407	6153	10194	6670	7601
Fan Bilgileri	Çap	300x3			350x3			400x3			
Batarya Bilgileri	Yüzey Alanı m ²	12,7	17,0	21,2	17,6	23,5	29,3	35,2	28,0	35,0	40,5

Kod	AEY 345 38	AEY 345 48	AEY 345 58	AEY 345 68	AEY 350 38	AEY 350 48	AEY 350 58	AEY 350 68	AEY 350 58 V2	AEY 350 68 V2	
Kapasite	SC 1	14988	19004	22857	25684	17512	22263	26494	30239	32485	37260
	SC 2	10721	13600	16305	18401	12605	16036	19096	21808	23234	26661
	SC 3	8350	10604	12690	14481	9994	12505	14932	17103	17563	20185
	SC 4	6807	8661	10319	11729	8158	10177	12178	13978	23234	16386
Fan Bilgileri	Çap	450x3			500x3						
Batarya Bilgileri	Yüzey Alanı m ²	33,1	44,2	55,2	66,3	33,1	44,2	55,2	66,3	71,7	86,0

4 FANLI 8 mm LAMEL

Kod	AEY 430 38	AEY 430 48	AEY 430 58	AEY 435 38	AEY 435 48	AEY 435 58	AEY 435 68	AEY 440 48	AEY 440 58	AEY 440 68	
Kapasite	SC 1	6859	8570	10037	10720	13335	16016	18165	16736	19904	22464
	SC 2	4898	6125	7184	7677	9570	11469	13026	11944	14259	16102
	SC 3	3822	4790	5622	5918	7595	8721	9907	9411	10821	12391
	SC 4	3102	3868	4525	4809	6184	7089	8064	7609	8794	10111
Fan Bilgileri	Çap	300x4			350x4			400x4			
Batarya Bilgileri	Yüzey Alanı m ²	17,0	22,7	28,3	23,5	31,3	39,1	46,9	37,4	46,7	56,1

SOĞUTUCULAR

AEY SOĞUK ODA



4 FANLI 8 mm LAMEL

Kod	AEY 445 38	AEY 445 48	AEY 445 58	AEY 445 68	AEY 450 38	AEY 450 48	AEY 450 58	AEY 450 68	AEY 450 58 V2	AEY 450 68 V2	
Kapasite	SC 1	19868	25407	29992	34031	23653	30122	35503	40252	43737	49847
	SC 2	14212	18157	21449	24364	17063	21727	25626	29081	31388	35801
	SC 3	11089	14061	16724	19171	13306	16822	20032	22884	23892	27383
	SC 4	9047	11474	13689	15531	10728	13566	16346	18720	19398	22276
Fan Bilgileri	Çap	450x4				500x4					
	Batarya Bilgileri	Yüzey Alanı m ²	44,2	58,9	73,6	88,4	44,2	58,9	73,6	88,4	95,6

SOĞUTUCULAR

TAVAN TİPİ



AD 6 MM 1-2 FAN

Kod	AD 125-46	AD 125-56	AD 130-46	AD 130-56	AD 130-66	AD 135-56	AD 135-66	AD 225-46	AD 225-56	AD 230-46	AD 230-56	AD 230-66	AD 235-56	AD 235-66	
Kapasite	SC 1	719	968	1621	1813	2164	2378	2800	2006	2458	2996	3446	3945	4855	5395
	SC 2	501	657	1183	1275	1573	1734	2028	1453	1765	2103	2386	2863	3542	3923
	SC 3	446	564	958	1023	1233	1426	1529	1140	1345	1736	1948	2268	2832	3083
	SC 4	-	-	-	-	-	-	-	-	-	-	-	-	-	-
Çap	250x1	250x1	300x1	300x1	300x1	350x1	350x1	250x2	250x2	300x2	300x2	300x2	350x2	350x2	
Fan Sayısı	1 FANLI						2 FANLI								
Batarya Bilgileri	Yüzey Alanı m ²	3,4	4,2	4,6	5,8	7,0	6,5	7,8	6,4	8,0	8,8	11,0	13,2	12,4	14,9

SOĞUTUCULAR

TAVAN TİPİ



AD 6 MM 3-4 FAN

Kod	AD 325-46	AD 325-56	AD 330-46	AD 330-56	AD 330-66	AD 335-56	AD 335-66	AD 425-46	AD 425-56	AD 430-46	AD 430-56	AD 430-66	AD 435-56	AD 435-66	
Kapasite	SC 1	2967	3616	5001	5780	6259	7312	8227	4192	4913	6703	7707	8430	9438	10492
	SC 2	2082	2618	3619	4180	4563	5333	5980	3038	3532	4828	5589	6117	6895	7635
	SC 3	1694	2103	2849	3163	3654	4281	4641	2452	2776	3641	4350	4705	5595	6080
	SC 4	-	-	-	-	-	-	-	-	-	-	-	-	-	-
	Çap	250x3	250x3	300x3	300x3	300x3	350x3	350x3	250x4	250x4	300x4	300x4	300x4	350x4	350x4
	Fan Sayısı	3 FANLI						4 FANLI							
Batarya Bilgileri	Yüzey Alanı m ²	9,6	12,0	13,2	16,5	19,8	18,6	22,3	12,8	16,0	17,6	22,0	26,4	24,0	28,7

AD 8 MM 1-2 FANLI

Kod	AD 125-48	AD 125-58	AD 130-48	AD 130-58	AD 130-68	AD 135-58	AD 135-68	AD 225-48	AD 225-58	AD 230-48	AD 230-58	AD 230-68	AD 235-58	AD 235-68	
Kapasite	SC 1	690	995	1345	1687	1898	2201	2468	1838	2134	2887	3224	3695	4239	4771
	SC 2	475	672	903	1222	1373	1603	1790	1329	1539	2075	2342	2684	3089	3466
	SC 3	417	558	748	972	1082	1271	1408	1058	1207	1575	1874	2149	2510	2772
	SC 4	342	455	600	773	858	1039	1135	841	960	1277	1500	1715	2049	2249
	Çap	250x1	250x1	300x1	300x1	300x1	350x1	350x1	250x2	250x2	300x2	300x2	300x2	350x2	350x2
	Fan Sayısı	1 FANLI						2 FANLI							
Batarya Bilgileri	Yüzey Alanı m ²	2,6	3,3	3,6	4,5	5,4	5,0	6,0	4,96	6,2	6,8	8,5	10,2	9,6	11,5

AD 8 MM 3-4 FANLI

Kod	AD 325-48	AD 325-58	AD 330-48	AD 330-58	AD 330-68	AD 335-58	AD 335-68	AD 425-48	AD 425-58	AD 430-48	AD 430-58	AD 430-68	AD 435-58	AD 435-68	
Kapasite	SC 1	2820	3150	4306	5096	5557	6375	8227	3617	4298	5826	6759	7531	8217	9253
	SC 2	2025	2280	3108	3676	4036	4647	5980	2616	3100	4191	4886	5447	5997	6731
	SC 3	1527	1796	2482	2818	3241	3787	4641	2068	2448	3207	3836	4257	4927	5437
	SC 4	1238	1450	2018	2293	2596	3100	3790	1654	1960	2608	3144	3452	4034	4419
	Çap	250x3	250x3	300x3	300x3	300x3	350x3	350x3	250x4	250x4	300x4	300x4	300x4	350x4	350x4
	Fan Sayısı	3 FANLI						4 FANLI							
Batarya Bilgileri	Yüzey Alanı m ²	7,4	9,3	10,2	12,7	15,3	14,3	22,3	9,9	12,4	13,6	17,0	20,4	18,5	22,2

SOĞUTUCULAR

SOĞUK ODA



Model	Yüzey (m ²)	Boru Hacmi (dm ³)	Kapasite				Fanlar	
			SC 1 Te= 0°C T0= +10°C	SC 2 Te= -8°C T0= 0°C	SC 3 Te= -25°C T0= -18°C	SC 4 Te= -31°C T0= -25°C	Fan Sayısı (n)	Fan Çapı (Ø mm)
			(Watt)	(Watt)	(Watt)	(Watt)		
MSD-MSA-MSS-MSO SERİSİ								
MSA25 111	6,27	1,55	1.700	1.160	920	-	1	250
MSA25 112	8,36	2,07	1.970	1.340	1.040	-	1	250
MSA30 111	6,27	1,55	2.522	1.694	1.252	-	1	300
MSA30 112	8,36	2,07	3.020	2.050	1.645	-	1	300
MSA30 114	12,54	3,10	3.751	2.562	2.000	-	1	300
MSA25 211	12,53	3,10	3.400	2.320	1.840	-	2	250
MSA25 212	16,71	4,13	3.950	2.680	2.090	-	2	250
MSA30 211	12,53	3,10	5.044	3.388	2.504	-	2	300
MSA30 212	16,71	4,13	6.040	4.100	3.290	-	2	300
MSA30 311	18,80	4,65	7.566	5.082	3.756	-	3	300
MSA30 312	25,07	6,20	9.060	6.150	4.935	-	3	300
MSA30 314	37,61	9,30	11.253	7.686	6.000	-	3	300
MSA35 111	8,36	2,05	3.961	2.680	2.135	-	1	350
MSA35 112	11,15	2,73	4.764	3.243	2.610	-	1	350
MSA35 114	16,72	4,10	6.067	4.131	3.233	-	1	350
MSA40 111	8,36	2,05	4.375	2.950	2.333	-	1	400
MSA40 112	11,15	2,73	5.263	3.574	2.900	-	1	400
MSA40 114	16,72	4,10	6.660	4.560	3.675	-	1	400
MSA35 211	16,72	4,10	7.922	5.360	4.270	-	2	350
MSA35 212	22,29	5,47	9.528	6.486	5.220	-	2	350
MSA35 214	33,44	8,20	12.134	8.262	6.466	-	2	350
MSA40 211	16,72	4,10	8.750	5.900	4.666	-	2	400
MSA40 212	22,29	5,47	10.526	7.148	5.800	-	2	400
MSA40 214	33,44	8,20	13.320	9.120	7.350	-	2	400
MSA35 311	25,08	6,15	11.883	8.040	6.405	-	3	350
MSA35 312	33,44	8,20	14.292	9.729	7.830	-	3	350
MSA35 314	50,16	12,30	18.201	12.393	9.699	-	3	350
MSA40 311	25,08	6,15	13.125	8.850	6.999	-	3	400

SOĞUTUCULAR

SOĞUK ODA



Model	Yüzey (m ²)	Boru Hacmi (dm ³)	Kapasite				Fanlar	
			SC 1	SC 2	SC 3	SC 4	Fan Sayısı (n)	Fan Çapı (Ø mm)
			Te= 0°C T0= +10°C (Watt)	Te= -8°C T0= 0°C (Watt)	Te= -25°C T0= -18°C (Watt)	Te= -31°C T0= -25°C (Watt)		
MSA40 312	33,44	8,20	15.789	10.722	8.700	-	3	400
MSA40 314	50,16	12,30	19.980	13.680	11.025	-	3	400
MSA45 211	28,98	7,05	14.188	9.580	7.500	-	2	450
MSA45 212	38,63	9,40	17.344	11.765	9.360	-	2	450
MSA45 214	57,95	14,10	21.927	15.000	12.120	-	2	450
MSA50 211	28,98	7,05	16.840	11.420	8.910	-	2	500
MSA50 212	38,63	9,40	20.200	13.700	10.700	-	2	500
MSA50 214	57,95	14,10	26.400	17.920	14.280	-	2	500
MSA45 312	57,95	14,10	26.016	17.648	14.040	-	3	450
MSA45 314	86,93	21,15	32.891	22.500	18.180	-	3	450
MSA50 312	57,95	14,10	30.310	20.560	16.050	-	3	500
MSA50 314	86,93	21,15	39.800	27.000	20.950	-	3	500
MSA45 412	77,27	18,80	34.688	23.530	18.720	-	4	450
MSA45 414	115,90	28,20	43.854	30.000	24.240	-	4	450
MSA50 412	77,27	18,80	40.410	27.410	21.400	-	4	500
MSA50 414	115,90	28,20	53.550	36.400	28.200	-	4	500
MSA63 212	92,86	22,60	38.175	25.906	-	-	2	630
MSA63 214	139,30	33,90	48.162	32.696	-	-	2	630
MSA63 312	139,29	33,90	57.263	38.859	-	-	3	630
MSA63 314	208,95	50,85	72.243	49.044	-	-	3	630
MSA63 412	185,72	45,20	76.350	51.812	-	-	4	630
MSA63 414	278,60	67,80	96.324	65.392	-	-	4	630
MSA63 512	232,15	56,50	95.438	64.765	-	-	5	630
MSA63 514	348,25	84,75	120.405	81.740	-	-	5	630
MSS30 111	4,84	1,55	2.144	1.444	1.104	871	1	300
MSS30 112	6,45	2,07	2.577	1.710	1.388	1.121	1	300
MSS30 114	9,67	3,10	3.350	2.290	1.791	1.415	1	300
MSS30 211	9,67	3,10	4.288	2.888	2.208	1.742	2	300

SOĞUTUCULAR

SOĞUK ODA



Model	Yüzey (m ²)	Boru Hacmi (dm ³)	Kapasite				Fanlar	
			SC 1 Te= 0°C T0= +10°C	SC 2 Te= -8°C T0= 0°C	SC 3 Te= -25°C T0= -18°C	SC 4 Te= -31°C T0= -25°C	Fan Sayısı (n)	Fan Çapı (Ø mm)
			(Watt)	(Watt)	(Watt)	(Watt)		
MSS30 212	12,90	4,13	5.154	3.420	2.776	2.242	2	300
MSS30 214	19,35	6,20	6.700	4.580	3.582	2.830	2	300
MSS30 311	14,51	4,65	6.432	4.332	3.312	2.613	3	300
MSS30 312	19,35	6,20	7.731	5.130	4.164	3.363	3	300
MSS30 314	29,02	9,30	10.050	6.870	5.373	4.245	3	300
MSS35 111	6,45	2,05	3.300	2.250	1.810	1.460	1	350
MSS35 112	8,60	2,73	4.000	2.630	2.120	1.700	1	350
MSS35 114	12,90	4,10	5.250	3.500	2.840	2.300	1	350
MSS40 111	6,45	2,05	3.671	2.478	1.984	1.572	1	400
MSS40 112	8,60	2,73	4.471	2.993	2.420	1.937	1	400
MSS40 114	12,90	4,10	5.840	3.930	3.173	2.550	1	400
MSS35 211	12,90	4,10	6.600	4.500	3.620	2.920	2	350
MSS35 212	17,19	5,47	8.000	5.260	4.240	3.400	2	350
MSS35 214	25,79	8,20	10.500	7.000	5.680	4.600	2	350
MSS40 211	12,90	4,10	7.342	4.956	3.968	3.144	2	400
MSS40 212	17,19	5,47	8.942	5.986	4.840	3.874	2	400
MSS40 214	25,79	8,20	11.680	7.860	6.346	5.100	2	400
MSS35 311	19,35	6,15	9.900	6.750	5.430	4.380	3	350
MSS35 312	25,79	8,20	12.000	7.890	6.360	5.100	3	350
MSS35 314	38,69	12,30	15.750	10.500	8.520	6.900	3	350
MSS40 311	19,35	6,15	11.013	7.434	5.952	4.716	3	400
MSS40 312	25,79	8,20	13.413	8.979	7.260	5.811	3	400
MSS40 314	38,69	12,30	17.520	11.790	9.519	7.650	3	400
MSS45 211	22,35	7,05	11.830	8.020	6.400	5.157	2	450
MSS45 212	29,80	9,40	14.737	10.000	8.000	6.420	2	450
MSS45 214	44,71	14,10	19.191	13.111	10.550	8.480	2	450
MSS45 215	59,61	18,80	22.300	15.087	12.300	9.980	2	450
MSS50 211	22,35	7,05	14.290	9.680	7.640	6.170	2	500
MSS50 212	29,80	9,40	17.610	11.930	9.420	7.600	2	500

SOĞUTUCULAR

SOĞUK ODA



Model	Yüzey (m ²)	Boru Hacmi (dm ³)	Kapasite				Fanlar	
			SC 1 Te= 0°C T0= +10°C	SC 2 Te= -8°C T0= 0°C	SC 3 Te= -25°C T0= -18°C	SC 4 Te= -31°C T0= -25°C	Fan Sayısı (n)	Fan Çapı (Ø mm)
			(Watt)	(Watt)	(Watt)	(Watt)		
MSS50 214	44,71	14,10	23.180	15.740	12.640	10.180	2	500
MSS50 215	59,61	18,80	27.730	18.800	14.830	11.970	2	500
MSS45 311	33,53	10,58	17.745	12.030	9.600	7.736	3	450
MSS45 312	44,71	14,10	22.106	15.000	12.000	9.630	3	450
MSS45 314	67,06	21,15	28.787	19.667	15.825	12.720	3	450
MSS45 315	89,41	28,20	33.450	22.631	18.450	14.970	3	450
MSS50 311	33,53	10,58	21.440	14.530	11.470	9.250	3	500
MSS50 312	44,71	14,10	26.410	17.900	14.130	11.400	3	500
MSS50 314	67,06	21,15	35.100	24.000	18.850	15.120	3	500
MSS50 315	89,41	28,20	41.600	28.200	22.250	17.950	3	500
MSS45 411	44,71	14,10	23.660	16.040	12.800	10.314	4	450
MSS45 412	59,61	18,80	29.474	20.000	16.000	12.840	4	450
MSS45 414	89,41	28,20	38.382	26.222	21.100	16.960	4	450
MSS45 415	119,21	37,60	44.600	30.174	24.600	19.960	4	450
MSS50 411	44,71	14,10	28.590	19.370	15.290	12.340	4	500
MSS50 412	59,61	18,80	35.220	23.870	18.840	15.200	4	500
MSS50 414	89,41	28,20	47.200	32.000	25.200	20.380	4	500
MSS50 415	119,21	37,60	55.470	37.600	29.670	23.940	4	500
MSS63 212	71,64	22,60	32.494	22.045	17.643	14.085	2	630
MSS63 214	107,46	33,90	42.582	28.916	23.142	18.475	2	630
MSS63 312	107,46	33,90	48.741	33.068	26.465	21.128	3	630
MSS63 314	161,19	50,85	63.873	43.374	34.713	27.713	3	630
MSS63 412	143,28	45,20	64.988	44.090	35.286	28.170	4	630
MSS63 414	214,92	67,80	85.164	57.832	46.284	36.950	4	630
MSS63 512	179,10	56,50	81.235	55.113	44.108	35.213	5	630
MSS63 514	268,65	84,75	106.455	72.290	57.855	46.188	5	630

SOĞUTUCULAR

TAVAN TİPİ





Model	Yüzey (m ²)	Boru Hacmi (dm ³)	Kapasite				Fanlar	
			SC 1 Te= 0°C T0= +10°C	SC 2 Te= -8°C T0= 0°C	SC 3 Te= -25°C T0= -18°C	SC 4 Te= -31°C T0= -25°C	Fan Sayısı (n)	Fan Çapı (Ø mm)
			(Watt)	(Watt)	(Watt)	(Watt)		
MTA - MTS SERİSİ								
MTA30 111	5,57	1,4	2.340	1.580	1.202	-	1	300
MTA30 112	6,96	1,7	2.560	1.702	1.400	-	1	300
MTA35 111	6,68	1,6	3.300	2.191	1.538	-	1	350
MTA35 112	8,35	2,0	3.736	2.541	2.046	-	1	350
MTA30 211	11,14	2,8	4.680	3.160	2.404	-	2	300
MTA30 212	13,92	3,4	5.120	3.404	2.800	-	2	300
MTA35 211	13,36	3,2	6.600	4.382	3.076	-	2	350
MTA35 212	16,70	4,0	7.472	5.082	4.092	-	2	350
MTA30 311	16,71	4,2	7.020	4.740	3.606	-	3	300
MTA30 312	20,88	5,1	7.680	5.106	4.200	-	3	300
MTS30 111	4,29	1,4	2.024	1.368	1.067	850	1	300
MTS30 112	5,37	1,7	2.186	1.450	1.200	974	1	300
MTS35 111	5,16	1,6	2.891	1.927	1.393	1.095	1	350
MTS35 112	6,45	2,0	3.274	2.227	1.790	1.425	1	350
MTS30 211	8,58	2,8	4.048	2.736	2.134	1.700	2	300
MTS30 212	10,74	3,4	4.372	2.900	2.400	1.948	2	300
MTS35 211	10,32	3,2	5.782	3.854	2.786	2.190	2	350
MTS35 212	12,90	4,0	6.548	4.454	3.580	2.850	2	350
MTS30 311	12,87	4,2	6.072	4.104	3.201	2.550	3	300
MTS30 312	16,11	5,1	6.558	4.350	3.600	2.922	3	300

SOĞUK HAVA DEPOSU EKİPMANLARI

PANELLER

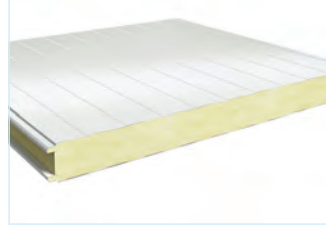

600 MM Sandviç Panel



800 MM Sandviç Panel

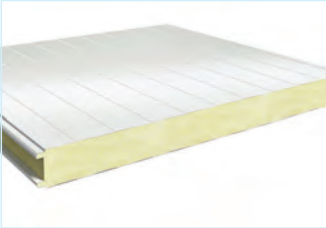

1000 MM Sandviç Panel

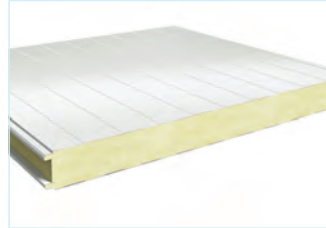

1200 MM Sandviç Panel

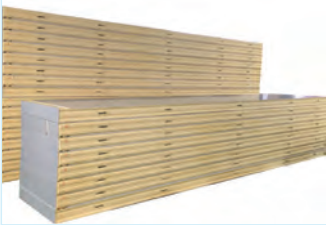

1000 MM Kilitli Sandviç Panel

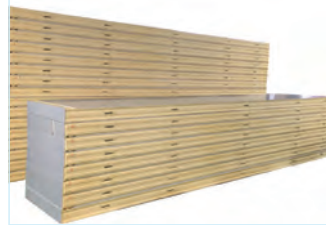

1200 MM Kilitli Sandviç Panel

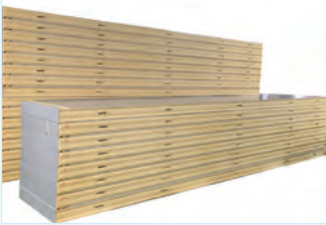

1500 MM Kilitli Sandviç Panel

SOĞUK HAVA DEPOSU EKİPMANLARI

NEMLENDİRME CİHAZLARI



Cuoghi Mini Neb Nemlendirme Cihazı



Nebula Master 250 Plus Nemlendirme Cihazı



Nebula Master 500 Plus Nemlendirme Cihazı



Nebula Master 900 Plus Nemlendirme Cihazı

SOĞUK HAVA DEPOSU EKİPMANLARI

SOĞUK ODA KAPILARI

Soğuk Hava Depo Kapıları
Menteşeli TipSoğuk Hava Depo Kapıları
Sürgülü Tip

SOĞUK HAVA DEPOSU EKİPMANLARI

KAPI CONTALARI

İ-408-01B

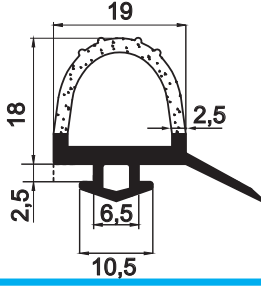

İ-408-02B

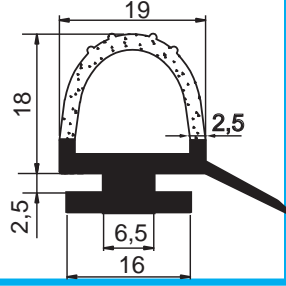

İ-408-03B

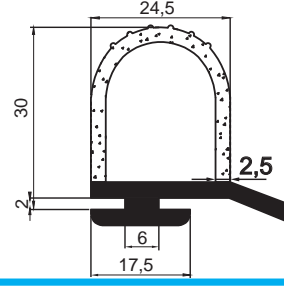

İ-408-04B

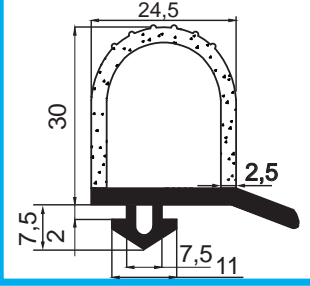

İ-408-01BK

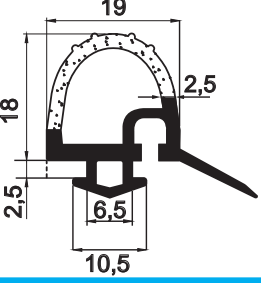

İ-408-02BK

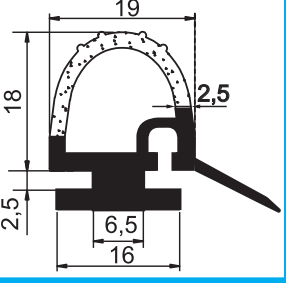

İ-408-03BK

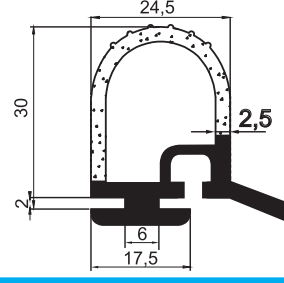

İ-408-04BK

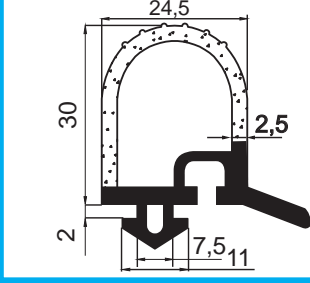

İ-408-05B

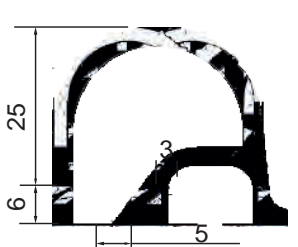

İ-755-E

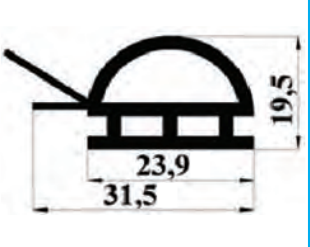

İ-TK7

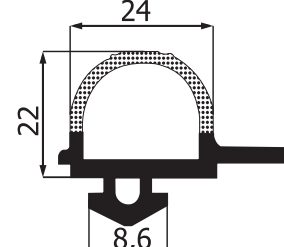

İ-TP-01

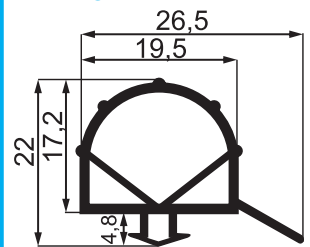

SOĞUK HAVA DEPOSU EKİPMANLARI

KAPI CONTALARI

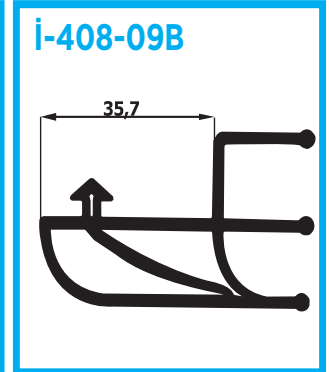
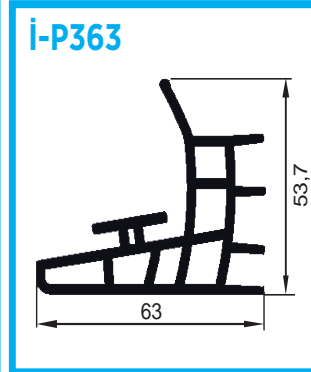
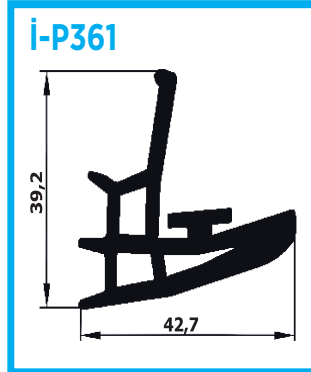
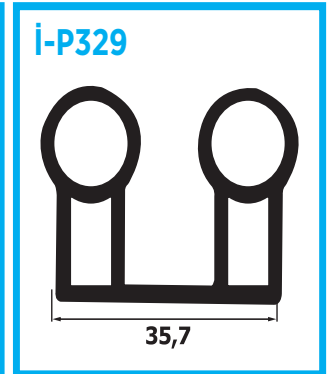
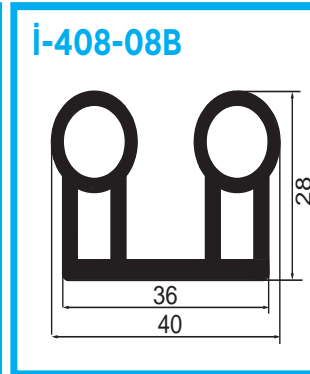
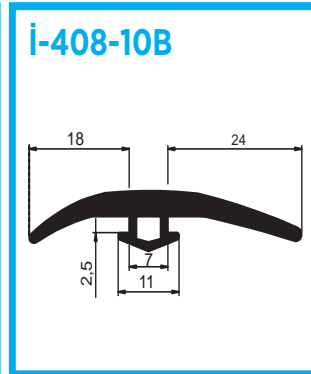
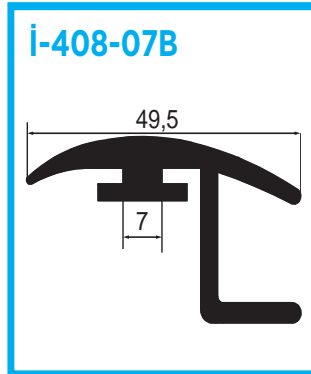
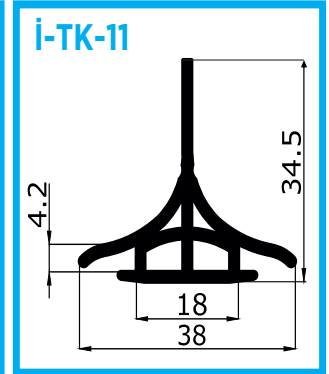
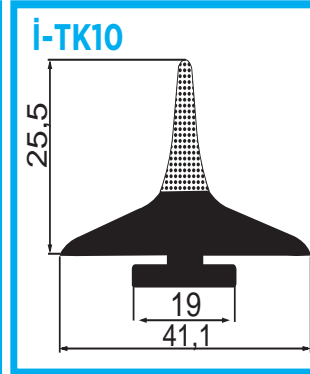
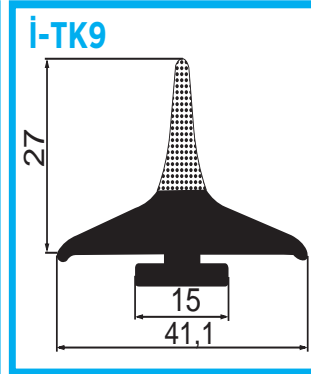
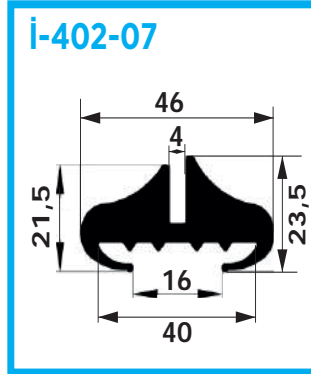
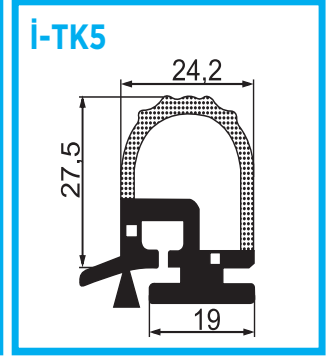
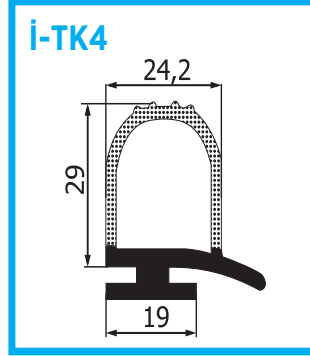
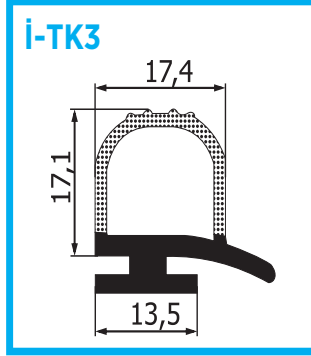
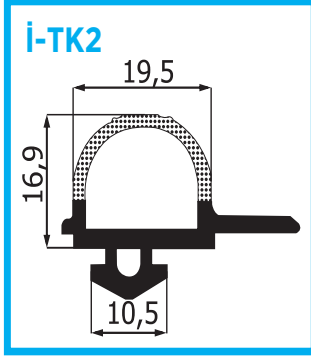

SOĞUK HAVA DEPOSU EKİPMANLARI

KAPI CONTALARI

i-P359-CK

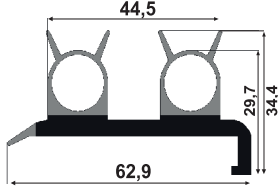

i-P359-SK

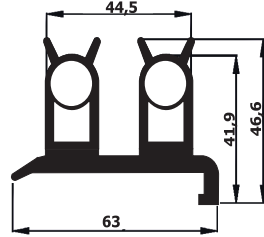

i-P360-EK

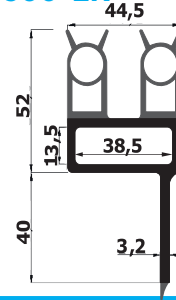

i-TK-6

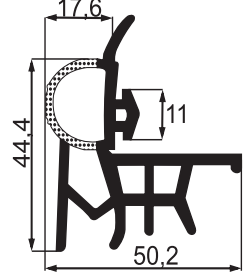

i-408-11B

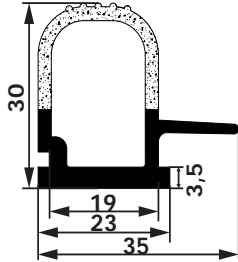

i-762-ERM

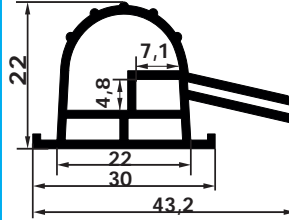

i-408-12B

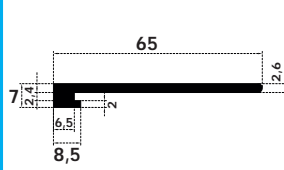

i-TK-11B

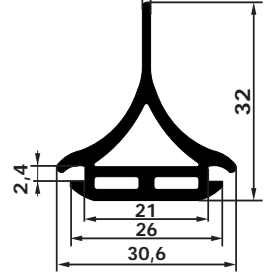

SOĞUK HAVA DEPOSU EKİPMANLARI

KAPI KİLİTLERİ ve MENTEŞELERİ



i-266 Kapı Kilidi



i-366 Kapı Kilidi



i-259 Kapı Kilidi



i34-01 Menteşe



i34-br Menteşe



i-34 Menteşe

SOĞUK HAVA DEPOSU EKİPMANLARI

AKSESUARLAR

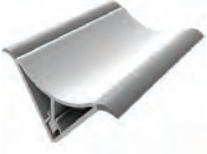

İç Köşe Hijyen Plastik 7 cm

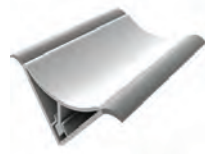

2-İç Köşe Hijyen Plastik 10 cm



Dış Köşe Hijyen Plastik 6x12



Dış Köşe Hijyen Plastik 6x14

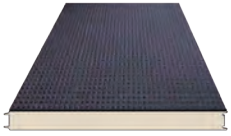

Taban Plywood

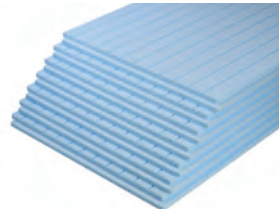

Taban Strafor

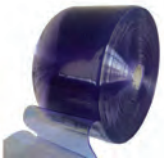

Soğuk Oda Kapı Perdesi Şeffaf



Soğuk Oda Kapı Perde Askısı



Basınç Dengeleme Valfi

ISITICILAR

	TİPİ	UZUNLUK	VOLTAJ	GÜÇ WATT	ÖZELLİK
	Drenaj Isıtıcı	1 Mt	230 V	50w	Silikon İzolasyonlu
	Drenaj Isıtıcı	1,5 Mt	230 V	75w	Silikon İzolasyonlu
	Drenaj Isıtıcı	2 Mt	230 V	100w	Silikon İzolasyonlu
	Drenaj Isıtıcı	3 Mt	230 V	150w	Silikon İzolasyonlu
	Drenaj Isıtıcı	4 Mt	230 V	200w	Silikon İzolasyonlu
	Drenaj Isıtıcı	5 Mt	230 V	250w	Silikon İzolasyonlu
	Drenaj Isıtıcı	6 Mt	230 V	300w	Silikon İzolasyonlu
	Kapı Isıtıcı	6 Mt	230 V	180w	Silikon İzolasyonlu
	Kesilebilir Isıtıcı	-	230 V	30-50/mt	Silikon İzolasyonlu

	TİPİ	UZUNLUK	ÖZELLİK
	Fişek Isıtıcılar	420 mm	Çift Taraflı Çubuk Defrost Isıtıcı
	Fişek Isıtıcılar	450 mm	Çift Taraflı Çubuk Defrost Isıtıcı
	Fişek Isıtıcılar	500 mm	Çift Taraflı Çubuk Defrost Isıtıcı
	Fişek Isıtıcılar	550 mm	Çift Taraflı Çubuk Defrost Isıtıcı
	Fişek Isıtıcılar	580 mm	Çift Taraflı Çubuk Defrost Isıtıcı
	Fişek Isıtıcılar	600 mm	Çift Taraflı Çubuk Defrost Isıtıcı
	Fişek Isıtıcılar	620 mm	Çift Taraflı Çubuk Defrost Isıtıcı
	Fişek Isıtıcılar	650 mm	Çift Taraflı Çubuk Defrost Isıtıcı
	Fişek Isıtıcılar	690 mm	Çift Taraflı Çubuk Defrost Isıtıcı
	Fişek Isıtıcılar	700 mm	Çift Taraflı Çubuk Defrost Isıtıcı
	Fişek Isıtıcılar	720 mm	Çift Taraflı Çubuk Defrost Isıtıcı
	Fişek Isıtıcılar	760 mm	Çift Taraflı Çubuk Defrost Isıtıcı
	Fişek Isıtıcılar	800 mm	Çift Taraflı Çubuk Defrost Isıtıcı
	Fişek Isıtıcılar	860 mm	Çift Taraflı Çubuk Defrost Isıtıcı
	Fişek Isıtıcılar	890 mm	Çift Taraflı Çubuk Defrost Isıtıcı
	Fişek Isıtıcılar	900 mm	Çift Taraflı Çubuk Defrost Isıtıcı
	Fişek Isıtıcılar	950 mm	Çift Taraflı Çubuk Defrost Isıtıcı
	Fişek Isıtıcılar	1000 mm	Çift Taraflı Çubuk Defrost Isıtıcı
	Fişek Isıtıcılar	1050 mm	Çift Taraflı Çubuk Defrost Isıtıcı
	Fişek Isıtıcılar	1100 mm	Çift Taraflı Çubuk Defrost Isıtıcı
	Fişek Isıtıcılar	1130 mm	Çift Taraflı Çubuk Defrost Isıtıcı
	Fişek Isıtıcılar	1150 mm	Çift Taraflı Çubuk Defrost Isıtıcı
	Fişek Isıtıcılar	1180 mm	Çift Taraflı Çubuk Defrost Isıtıcı
	Fişek Isıtıcılar	1200 mm	Çift Taraflı Çubuk Defrost Isıtıcı
	Fişek Isıtıcılar	1250 mm	Çift Taraflı Çubuk Defrost Isıtıcı
	Fişek Isıtıcılar	1270 mm	Çift Taraflı Çubuk Defrost Isıtıcı
	Fişek Isıtıcılar	1300 mm	Çift Taraflı Çubuk Defrost Isıtıcı
	Fişek Isıtıcılar	1320 mm	Çift Taraflı Çubuk Defrost Isıtıcı
	Fişek Isıtıcılar	1350 mm	Çift Taraflı Çubuk Defrost Isıtıcı
	Fişek Isıtıcılar	1370 mm	Çift Taraflı Çubuk Defrost Isıtıcı
Fişek Isıtıcılar	1400 mm	Çift Taraflı Çubuk Defrost Isıtıcı	
Fişek Isıtıcılar	1450 mm	Çift Taraflı Çubuk Defrost Isıtıcı	
Fişek Isıtıcılar	1500 mm	Çift Taraflı Çubuk Defrost Isıtıcı	
Fişek Isıtıcılar	1550 mm	Çift Taraflı Çubuk Defrost Isıtıcı	

ISITICILAR

	TİPİ	UZUNLUK	ÖZELLİK
	Fişek Isıtıcılar	1600 mm	Çift Taraflı Çubuk Defrost Isıtıcı
	Fişek Isıtıcılar	1620 mm	Çift Taraflı Çubuk Defrost Isıtıcı
	Fişek Isıtıcılar	1650 mm	Çift Taraflı Çubuk Defrost Isıtıcı
	Fişek Isıtıcılar	1670 mm	Çift Taraflı Çubuk Defrost Isıtıcı
	Fişek Isıtıcılar	1700 mm	Çift Taraflı Çubuk Defrost Isıtıcı
	Fişek Isıtıcılar	1750 mm	Çift Taraflı Çubuk Defrost Isıtıcı
	Fişek Isıtıcılar	1790 mm	Çift Taraflı Çubuk Defrost Isıtıcı
	Fişek Isıtıcılar	1820 mm	Çift Taraflı Çubuk Defrost Isıtıcı
	Fişek Isıtıcılar	1850 mm	Çift Taraflı Çubuk Defrost Isıtıcı
	Fişek Isıtıcılar	1950 mm	Çift Taraflı Çubuk Defrost Isıtıcı
	Fişek Isıtıcılar	2000 mm	Çift Taraflı Çubuk Defrost Isıtıcı
	Fişek Isıtıcılar	2050 mm	Çift Taraflı Çubuk Defrost Isıtıcı
	Fişek Isıtıcılar	2100 mm	Çift Taraflı Çubuk Defrost Isıtıcı
	Fişek Isıtıcılar	2150 mm	Çift Taraflı Çubuk Defrost Isıtıcı
	Fişek Isıtıcılar	2200 mm	Çift Taraflı Çubuk Defrost Isıtıcı
	Fişek Isıtıcılar	2250 mm	Çift Taraflı Çubuk Defrost Isıtıcı
	Fişek Isıtıcılar	2300 mm	Çift Taraflı Çubuk Defrost Isıtıcı
	Fişek Isıtıcılar	2350 mm	Çift Taraflı Çubuk Defrost Isıtıcı
	Fişek Isıtıcılar	2400 mm	Çift Taraflı Çubuk Defrost Isıtıcı
	Fişek Isıtıcılar	2450 mm	Çift Taraflı Çubuk Defrost Isıtıcı
	Fişek Isıtıcılar	2480 mm	Çift Taraflı Çubuk Defrost Isıtıcı
	Fişek Isıtıcılar	2500 mm	Çift Taraflı Çubuk Defrost Isıtıcı
	Fişek Isıtıcılar	2550 mm	Çift Taraflı Çubuk Defrost Isıtıcı
	Fişek Isıtıcılar	2650 mm	Çift Taraflı Çubuk Defrost Isıtıcı
	Fişek Isıtıcılar	2700 mm	Çift Taraflı Çubuk Defrost Isıtıcı
	Fişek Isıtıcılar	2750 mm	Çift Taraflı Çubuk Defrost Isıtıcı
	Fişek Isıtıcılar	2800 mm	Çift Taraflı Çubuk Defrost Isıtıcı
	Fişek Isıtıcılar	2850 mm	Çift Taraflı Çubuk Defrost Isıtıcı
	Fişek Isıtıcılar	2900 mm	Çift Taraflı Çubuk Defrost Isıtıcı
	Fişek Isıtıcılar	2950 mm	Çift Taraflı Çubuk Defrost Isıtıcı
	Fişek Isıtıcılar	3000 mm	Çift Taraflı Çubuk Defrost Isıtıcı
	Fişek Isıtıcılar	3050 mm	Çift Taraflı Çubuk Defrost Isıtıcı
Fişek Isıtıcılar	3100 mm	Çift Taraflı Çubuk Defrost Isıtıcı	
Fişek Isıtıcılar	3150 mm	Çift Taraflı Çubuk Defrost Isıtıcı	
Fişek Isıtıcılar	3200 mm	Çift Taraflı Çubuk Defrost Isıtıcı	

BAKIR BORULAR

	TİPİ	ÇAP	ET KALINLIK
	Split		
	Bakır Boru	3/16"	0.70mm
	Bakır Boru	1/4"	0.70mm
	Bakır Boru	5/16"	0.70mm
	Bakır Boru	3/8"	0.70mm
	Bakır Boru	1/2"	0.70mm
	Bakır Boru	5/8"	0.70mm
	Bakır Boru	3/4"	0.70mm
	Vrv		
	Bakır Boru	1/4"	0.80mm (VRV)
	Bakır Boru	3/8"	0.80mm (VRV)
	Bakır Boru	1/2"	0.90mm (VRV)
	Bakır Boru	5/8"	1.00mm (VRV)
	Bakır Boru	3/4"	1.00mm (VRV)

	Boy Borular		
	Bakır Boru	(Boy)	10.00*1.00
	Bakır Boru	(Boy)	12.00*1.00
	Bakır Boru	(Boy)	15.00*0.75
	Bakır Boru	(Boy)	15.80*0.80
	Bakır Boru	(Boy)	15.00*1.00
	Bakır Boru	(Boy)	16.00*1.00
	Bakır Boru	(Boy)	18.00*0.75
	Bakır Boru	(Boy)	18.00*1.00
	Bakır Boru	(Boy)	19.00*1.00
	Bakır Boru	(Boy)	22.00*0.80
	Bakır Boru	(Boy)	22.00*1.00
	Bakır Boru	(Boy)	22.00*1.20
	Bakır Boru	(Boy)	22.00*2.00
	Bakır Boru	(Boy)	25.00*1.00
	Bakır Boru	(Boy)	25.00*1.20
	Bakır Boru	(Boy)	28.00*1.00
	Bakır Boru	(Boy)	28.00*1.20
	Bakır Boru	(Boy)	28.00*1.50
	Bakır Boru	(Boy)	35.00*1.00
	Bakır Boru	(Boy)	35.00*1.20
	Bakır Boru	(Boy)	35.00*1.50
	Bakır Boru	(Boy)	42.00*1.00
Bakır Boru	(Boy)	42.00*1.50	
Bakır Boru	(Boy)	54.00*1.00	
Bakır Boru	(Boy)	54.00*1.50	
Bakır Boru	(Boy)	54.00*2.00	

BAKIR BORULAR

	TİPİ	ÇAP
	Kılcal Borular	
	Bakır Kılcal Boru	0.80x1.85
	Bakır Kılcal Boru	0.90x1.90
	Bakır Kılcal Boru	1.00x2.00
	Bakır Kılcal Boru	1.10x2.10
	Bakır Kılcal Boru	1.20x2.20
	Bakır Kılcal Boru	1.30x2.30
	Bakır Kılcal Boru	1.50x2.50
	Bakır Kılcal Boru	1.80x2.80
	Bakır Kılcal Boru	2.00x3.00

BAKIR BAĞLANTI ELEMANLARI

RAKORLAR



Rakor 1 / 4



Rakor 3 / 8



Rakor 1 / 2



Rakor 5 / 8



Rakor 3 / 4

BAKIR BAĞLANTI ELEMANLARI

ÜNYONLAR



Ünyon 1 / 4 "



Ünyon 3 / 8 "



Ünyon 1 / 2 "



Ünyon 5 / 8 "



Ünyon 3 / 4 "

BAKIR BAĞLANTI ELEMANLARI

DİRSEKLER



Dirsek (5090) 1/4"



Dirsek (5090) 10 mm



Dirsek (5090) 1/2"



Dirsek (5090) 16 mm



Dirsek (5090) 3/4"



Dirsek (5090) 22 mm

BAKIR BAĞLANTI ELEMANLARI

MANŞONLAR



Manşon (5270) 10 mm



Manşon (5270) 12 mm



Manşon (5270) 1/2"

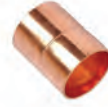

Manşon (5270) 15 mm



Manşon (5270) 16 mm

Manşon (5270) 19 mm
(3/4")

Manşon (5270) 22 mm



Manşon (5270) 25 mm



Manşon (5270) 28 mm

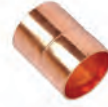

Manşon (5270) 35 mm

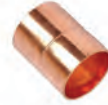

Manşon (5270) 42 mm

Manşon (5270) 54 mm (2
1/8")Manşon (5270) 67 mm (2
5/8")

BAKIR BAĞLANTI ELEMANLARI

TEE'LER



TEE (5130) 1/4"



TEE (5130) 10 mm



TEE (5130) 1/2"



TEE (5130) 16 mm



TEE (5130) 18 mm



TEE (5130) 3/4"



TEE (5130) 22 mm



TEE (5130) 28 mm



TEE (5130) 35 mm (1 3/8")



TEE (5130) 42 mm



TEE (5130) 54 mm (2 1/8")



TEE (5130) 67 mm (2 5/8")

BAKIR BAĞLANTI ELEMANLARI

REDÜKSİYONLAR



Redüksiyon (5240) 22*16 mm



Redüksiyon (5240) 28*16 mm



Redüksiyon (5240) 28*22 mm



Redüksiyon (5240) 35*22 mm



Redüksiyon (5240) 35*28 mm



Redüksiyon (5240) 42*22 mm



Redüksiyon (5240) 42*28 mm



Redüksiyon (5240) 42*35 mm



Redüksiyon (5240) 54*28 mm



Redüksiyon (5240) 54*42 mm

BAKIR BAĞLANTI ELEMANLARI

LÜPLER



Bakır Lüp 1/2



Bakır Lüp 5/8

BAKIR BAĞLANTI ELEMANLARI

LÜPLER



Bakır Lüp 3/4



Bakır Lüp 7/8



Bakır Lüp 1-1/8



Bakır Lüp 1-3/8



Bakır Lüp 1-5/8



Bakır Lüp 2-1/8

BAKIR BAĞLANTI ELEMANLARI

BAKIR BORU KELEPÇELERİ

Tekli Bakır Boru Kelepçesi
Tek Vidalı 10 mmTekli Bakır Boru Kelepçesi
Tek Vidalı 12 mmTekli Bakır Boru Kelepçesi
Çift Vidalı 16 mmTekli Bakır Boru Kelepçesi
Çift Vidalı 18 mmTekli Bakır Boru Kelepçesi
Çift Vidalı 22 mmTekli Bakır Boru Kelepçesi
Çift Vidalı 28 mm

BAKIR BAĞLANTI ELEMANLARI

BAKIR BORU KELEPÇELERİ



Tekli Bakır Boru Kelepçesi
Çift Vidalı 35 mm



Tekli Bakır Boru Kelepçesi
Çift Vidalı 42 mm



Tekli Bakır Boru Kelepçesi
Çift Vidalı 54 mm



TERMOSTATLAR

DİXELL DİJİTAL TERMOSTATLAR



Dixell XR02CX-5NOC1 Tek
Sensör Dijital Termostat



Dixell XR06CX-5NOC1 Çift
Sensör Dijital Termostat



Dixell XR20CX-3NOCO
(9-40V) Tek Sensör Dijital
Termostat



Dixell XR08CX-5NOC1
Karıştırıcı (Süt Tankı İçin)
Dijital Termostat



Dixell XT110C-5H1AU Tek
Sensör Nem Kontrol Dijital
Termostat



Dixell XLH260-500C1 Çift
Sensör Pano Tipi Sıcaklık ve
Nem Kontrol Dijital Termo-
stat



Dixell XH 20P-00000 Nem
Sensörü



Dixell XLR170-5N1C3 Çift
Sensör Pano Tipi Soğuk Oda
Dijital Termostat

TERMOSTATLAR

DİXELL DİJİTAL TERMOSTATLAR



Dixell XC660D-7C21F Dört
Sensör Pano Tipi Dijital
Termostat

TERMOSTATLAR

ENDA DİJİTAL TERMOSTATLAR



Enda EDT 3411 Tek Sensör
Dijital Termostat



Enda EDT 3423 Çift Sensör
Dijital Termostat



Enda EMTC 2412 Karıştırıcı
(Süt Tankı İçin) Dijital

TERMOSTATLAR

EVCO DİJİTAL TERMOSTATLAR



Evco EV3B01 Tek Sensör
Dokunmatik Dijital Termo-
stat



Evco EV3B23N7 Çift Sensör
Dokunmatik Dijital Termo-
stat



Evco EVK422 Karıştırıcı
(Süt Tankı İçin) Dijital

TERMOSTATLAR

GENERAL DİJİTAL TERMOSTATLAR



General ETC-961 Tek Sensör
Dijital Termostat



General ETC-974 Çift Sensör
Dijital Termostat

TERMOSTATLAR

EMKO DİJİTAL TERMOSTATLAR



Emko Esm 3711 Cn Tek
Sensör Dijital Termostat



Emko Esm 3712 Cn Çift
Sensör Dijital Termostat

TERMOSTATLAR

ELİWELL DİJİTAL TERMOSTATLAR



Eliwell EW Plus 961 Tek
Sensör Dijital Termostat



Eliwell EW Plus 974 Çift
Sensör Dijital Termostat



Eliwell EWRC 500 LX-2HP
Üç Sensör Pano Tipi Soğuk

EXPANSION VALFLER

HONEYWELL EXP. VALFLER VE ORİFİSLER



Honeywell TMV-00005
R12/134 İç Denge



Honeywell TMV-00001
R22/407 İç Denge



Honeywell TMV-00012
R404/502 İç Denge



Honeywell TMVX-00108
R404/502 Dış Denge



Honeywell TMVX-00112
R404/502 Dış Denge



Honeywell TMVD-00008
NO:0.5 Orifis



Honeywell TMVD-00009
NO:0.7 Orifis



Honeywell TMVD-00001
NO:1.0 Orifis



Honeywell TMVD-00002
NO:1.5 Orifis



Honeywell TMVD-00007
NO:4.5 Orifis





Honeywell TMVD-00011
NO:4.75 Orifis

EXPANSION VALFLER

DANFOSS EXP. VALFLER VE ORİFİSLER

	Orfis No	Kod No	R134a		R404A		R407C		R22	
			Kw	TON	Kw	TON	Kw	TON	Kw	TON
				T2 Orifis 0X	068-2002	0,68	0,19	0,64	0,18	0,92
	T2 Orifis 00	068-2003	1,20	0,34	1,30	0,37	1,80	0,51	1,8	0,51
	T2 Orifis 01	068-2010	2,10	0,59	2,60	0,75	3,5	1,00	3,5	0,99
	T2 Orifis 02	068-2015	2,50	0,73	3,70	1,10	4,8	1,40	4,7	1,30
	T2 Orifis 03	068-2006	4,30	1,20	6,30	1,80	8,1	2,30	8	2,30
	T2 Orifis 04	068-2007	6,40	1,80	9,90	2,80	12,4	3,50	12,10	3,50
	T2 Orifis 05	068-2008	8,40	2,30	13,00	3,70	16,5	4,70	16,70	4,80
	T2 Orifis 06	068-2009	10,10	2,90	15,50	4,40	19,7	5,60	19,70	5,60

	Gaz Tipi	Bağlantı	Dış Denge	İç Denge	Range/Mop	Kod No
	R404A / R507	Kaynaklı		TS2	N Mopsuz	068Z3414
			TES2		N Mopsuz	068Z3415
			TES2		NL -10°C	068Z3430
			TES2		B -20°C	068Z3421
	Rekorlu		TS2		N Mopsuz	068Z3400
			TS2		NM 0°C	068Z3406
			TS2		B -20°C	068Z3410
		TES2		N Mopsuz	068Z3403	
		TES2		NM 0°C	068Z3407	
		TES2		NL -10°C	068Z3409	
		TES2		B -20°C	068Z3411	

	Gaz Tipi	Bağlantı	Dış Denge	İç Denge	Range/Mop	Kod No
	R134A	Kaynaklı	TEN2		N Mopsuz	068Z3385
				TN2	N Mopsuz	068Z3383
		Rekorlu		TN2	N Mopsuz	068Z3346
			TEN2		N Mopsuz	068Z3348
			TEN2		NM 0°C	068Z3392
	TEN2		NL -10°C	068Z3370		
	R407C	Kaynaklı	TEZ2		N Mopsuz	068Z3446
		Rekorlu				068Z3501
	R448A R449A	Kaynaklı	TE2	N Mopsuz	068Z3730	20

EXPANSION VALFLER

DANFOSS EXP. VALFLER VE ORİFİSLER

	Model	Range N Mopsuz	Pak. Mik.	Range NM Mop 0°C	Pak. Mik.	Range NL Mop -10°C	Pak. Mik.	Range B Mop -20°C
	R404A / R507							
	TES 5	067B3342	12	067B3357	12	067B3358	12	067B3343
	TES 12	067B3347	9	067B3345	9	067B3348	9	067B3349
	TES 20	067B3352	9	067B3351	9	067B3353	9	067B3354
	TES 55	067G3302	9	067G3303	9	067G3304	9	067G3305

	Model	Range N Mopsuz	Pak. Mik.	Range NM Mop 0°C	Pak. Mik.	Range NL Mop -10°C	Pak. Mik.	Range B Mop -20°C
	R22							
	TEX 5	067B3250	12	067B3249	12	067B3253	12	067B3251
	TEX 12	067B3210	9	067B3207	9	067B3213	9	067B3211
	TEX 20	067B3274	9	067B3273	9	067B3275	9	067B3276
	TEX 55	067G3205	9	067G3206	9	-	-	067G3207

	Model	Range N Mopsuz	Pak. Mik.	Range NM Mop 0°C
	R134a			
	TEN 5	067B3297	12	067B3360
	TEN 12	067B3232	9	-
	TEN 20	067B3292	9	-
	TEN 55	067G3222	9	-

	Model	Range N Mopsuz	Pak. Mik.	Range NM Mop 0°C
	R407C			
	TEZ 5	067B3278	12	067B3277
	TEZ 12	067B3366	9	067B3367
	TEZ 20	067B3371	9	067B3372
	TEZ 55	067G3240	9	067G3241

	TİP	Kod No	R134a		R404A		R407C		R22		Orfis No
			Kw	TON	Kw	TON	Kw	TON	Kw	TON	
ORİFİS											
	TE5- 0,5	067B2788	6,7	1,9	8,1	2,3	10,7	3,1	10,4	3,0	0,5
	TE5 - 1	067B2789	12,2	3,5	14,8	4,2	19,6	5,6	19,0	5,4	1
	TE5 - 2	067B2790	17,0	4,8	20,4	5,8	27,1	7,7	26,3	7,5	2
	TE5 - 3	067B2791	21,8	6,2	26,2	7,5	34,7	9,9	33,8	9,6	3
	TE5 - 4	067B2792	29,7	8,5	35,5	10,1	47,3	13,5	45,9	13,1	4
	TE12 - 5	067B2708	37,7	10,7	50,0	14,3	56,0	16,0	57,0	16,2	5
	TE12 - 6	067B2709	50,0	14,3	64,0	18,2	74,0	21,1	76,0	21,7	6
	TE12 - 7	067B2710	66,0	18,8	81,0	23,1	94,0	26,8	98,0	27,9	7

EXPANSION VALFLER

DANFOSS EXP. VALFLER VE ORİFİSLER

	TİP	Kod No	R134a		R404A		R407C		R22		Orfis No
			Kw	TON	Kw	TON	Kw	TON	Kw	TON	
	TE20 - 8	067B2771	78,0	22,2	87,0	24,8	117,0	33,3	128,0	36,5	8
	TE20 - 9	067B2773	92,0	26,2	101,0	28,8	136,0	38,7	150,0	42,7	9
	TE55 - 10	067G2701	111,0	31,6	127,0	36,2	161,0	45,8	168,0	47,9	10
	TE55 - 11	067G2704	122,0	34,8	138,0	39,3	175,0	49,9	183,0	52,1	11
	TE55 - 12	067G2707	134,0	38,2	151,0	43,0	191,0	54,4	202,0	57,6	12
	TE55 - 13	067G2710	166,0	47,3	182,0	51,9	231,0	65,8	245,0	69,8	13

	TİP	Bağlantı	Rekorlu	Kaynaklı 90°C	Kaynaklı Düz
	TE 5	1/2" x 5/8"	067B4013	067B4009	067B4007
		1/2" x 7/8"		067B4010	067B4008
		5/8" x 7/8"		067B4011	067B4032
		7/8" x 11/8"		067B4034	067B4033
	TE 12	7/8" X 11/8"		067B4023	067B4021
	TE 20	7/8" X 11/8"		067B4023	067B4021
	TE 55	11/8" X 1 3/8"		067G4004	067G4003

EXPANSION VALFLER

DUNAN EXP. VALFLER VE ORİFİSLER

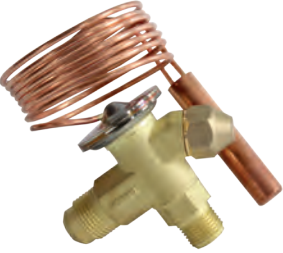
	TİP	Bağlantı	Rekorlu	Kaynaklı 90°C	Bağlantı Şekli
	430001070300	TIN	R-134A	İÇ DENGE	RAKORLU
	430001070400	TIEN	R-134A	DIŞ DENGE	RAKORLU
	430001080200	TIEN	R-134A	DIŞ DENGE	KAYNAKLI
	430002070300	TIS	R-404A	İÇ DENGE	RAKORLU
	430002070400	TIES	R-404A	DIŞ DENGE	RAKORLU
	430002080700	TIS	R-404A	İÇ DENGE	KAYNAKLI
	430002080800	TIES	R-404A	DIŞ DENGE	KAYNAKLI
	430000070300	TIX	R-22	İÇ DENGE	RAKORLU
	430000070400	TIEX	R-22	DIŞ DENGE	RAKORLU
	433900000001	OX		ORIFIS	
	433900000002	0		ORIFIS	
	433900000003	1		ORIFIS	
	433900000004	2		ORIFIS	
	433900000005	3		ORIFIS	
433900000006	4		ORIFIS		
433900000007	5		ORIFIS		
433900000008	6		ORIFIS		

EXPANSION VALFLER

SPORLAN EXP. VALFLER VE ORİFİSLER



MARKA	MODEL	GAZ CİNSİ	DENGE	BAĞLANTI
SPORLAN				
SPORLAN	ERSE-3 C	3 Ton	Dış Denge	(giriş:1/2" , çıkış:7/8")
SPORLAN	ERSE-4 C	4 Ton	Dış Denge	(giriş:1/2" , çıkış:7/8")
SPORLAN	ERSE-6 C	6 Ton	Dış Denge	(giriş:5/8" , çıkış:7/8")
SPORLAN	SSE - 3 C	3 Ton	Dış Denge	(giriş:1/2" , çıkış:7/8")
SPORLAN	SSE - 4 C	4 Ton	Dış Denge	(giriş:1/2" , çıkış:7/8")
SPORLAN	SSE - 6 C	6 Ton	Dış Denge	(giriş:5/8" , çıkış:7/8")
SPORLAN	SSE - 7 C	7 Ton	Dış Denge	(giriş:5/8" , çıkış:7/8")
SPORLAN	SSE - 10 C	10 Ton	Dış Denge	(giriş:5/8" , çıkış:7/8")
SPORLAN	HSE - 6 1/2 C	6,5 Ton	Dış Denge	(giriş:5/8" , çıkış:7/8")
SPORLAN	HSE - 9 C	9 Ton	Dış Denge	(giriş:5/8" , çıkış:7/8")
SPORLAN	HSE - 12 C	12 Ton	Dış Denge	(giriş:7/8" , çıkış:1 1/8")
SPORLAN	OSE-9 C	9 Ton	Dış Denge	(giriş:7/8" , çıkış:1 1/8")
SPORLAN	OSE - 12 C	12 Ton	Dış Denge	(giriş:5/8" , çıkış:7/8")
SPORLAN	OSE - 21 C	21 Ton	Dış Denge	(giriş:1 1/8" , çıkış:1 3/8")
SPORLAN	OSE - 30 C	30 Ton	Dış Denge	(giriş:1 1/8" , çıkış:1 3/8")

SOLENOID VALFLER

CASTEL





MODEL	BAĞLANTI UCU (CON.)	ORFİS MM
SOLENOİD VALFLER - RAKORLU		
C-1020/2	1 / 4	2,5
C-1020/3	3 / 8	3
C-1064/3	3 / 8	7
C-1064/4	1 / 2	7
C-1070/5	5 / 8	12,5
C-1090/6	3 / 4	16,5
BOBİNSİZ MODEL RAKORLU		
C-1020/3S	3 / 8	3
C-1064/3S	3 / 8	7
C-1064/4S	1 / 2	7
C-1090/6S	3 / 4	16,5
C-1034/3S PİSTONLU	3 / 8	6,5
C-1034/4S PİSTONLU	1 / 2	6,5
C-1040/4S PİSTONLU	1 / 2	12,5
C-1040/5S PİSTONLU	5 / 8	12,5

SOLENOİD VALFLER

CASTEL

	MODEL	BAĞLANTI UCU (CON.)	ORFİS MM
	SOLENOİD VALFLER - KAYNAKLI		
	C-1028/2A6	1 / 4	2,2
	C-1028/3A6	3 / 8	3
	C-1068/3A6	3 / 8	7
	C-1068/4A6	1 / 2	7
	C-1078/5A6	5 / 8	12,5
	C-1098/5A6	5 / 8	16,5
	C-1098/6A6	3 / 4	16,5
	C-1079/7A6	7 / 8	12,5
	C-1098/7A6	7 / 8	16,5
	C-1099/9A6	11 / 8	16,5
	C-1078/9A6	11 / 8	25,5
	C-1079/11A6	13 / 8	25,5
C-1079 / M42A6	42 mm	27	

	BOBİNSİZ MODEL KAYNAKLI		
	C-1038/3S PİSTONLU	3 / 8	6,5
	C-1038/4S PİSTONLU	1 / 2	6,5
	C-1048/4S PİSTONLU	1 / 2	12,5
	C-1048/5S PİSTONLU	5 / 8	12,5
	C-1049/7S PİSTONLU	7 / 8	12,5
	C-1068/3S	3/8	7
	C-1068/4S	1/2	7
	C-1078/4S	1 / 2	12,5
	C-1078/5S	5 / 8	12,5
	C-1098/5S	5 / 8	16,5

	MODEL	BAĞLANTI UCU (CON.)	ORFİS MM
	BOBİNSİZ MODEL KAYNAKLI		
	C-1098/6S	3 / 4	16,5
	C-1079/7S	7 / 8	12,5
	C-1098/7S	7 / 8	16,5
	C-1078/9S	1-1 / 8	25,5
	C-1078/M42S	42 mm	34
	C-1079/17S	2-1 / 8"	34

	MODEL	TİP	VOLTAJ (V)	GÜÇ
	BOBİNLER			
	9300/RA2	HM2	24 V	8 W
	9300/RA4	HM2	110 V	8 W
	9300/RA6	HM2	220 V / 230 V	8 W
	9320/RA6	HM3	220 V / 230 V	12 W
	9320/RD1	HM3	12 V - DC	20 W

SOLENOID VALFLER

CASTEL

MODEL	TİP	VOLTAJ (V)	GÜÇ
9320/RD2	HM3	24 V - DC	20 W
9160/RD1	HM4	12 V - DC	17 W
9160/RD2	HM4	24 V - DC	15,5 W
9160/RA2	HM4	24 V	8 W
9160/RA6	HM4	220 V / 230 V	8 W
9150/R02	HM2 ve HM3 BOBİNLER İÇİN KONNEKTÖR		
9155/R01	HM4 BOBİNLER İÇİN KONNEKTÖR		



SOLENOID VALFLER



DANFOSS

MODEL
Danfoss 032F1201 EVR 2 Solenoid Vana 1/4"Kay.
Danfoss 032F1206 EVR 3 Solenoid Vana 1/4"Kay.
Danfoss 032F1207 EVR 3 Solenoid Vana 6mm solder
Danfoss 032F1204 EVR 3 Solenoid Vana 3/8"Kay.
Danfoss 032L8079 EVR 6 Solenoid Vana 1/2"Rak.
Danfoss 032L8072 EVR 6 Solenoid Vana 3/8"Rak.
Danfoss 032F1213 EVR 6 Solenoid Vana 10mmKay.
Danfoss 032F1290 EVR 6 Solenoid Vana 3/8"Kay.(NO)
Danfoss 032L8098 EVR 10 Solenoid Vana 5/8"Rak.
Danfoss 032L1209 EVR 6 Solenoid Vana 1/2"Kay.
Danfoss 032F1217 EVR 10 Solenoid Vana 1/2"Kay.
Danfoss 032L1217 EVR 10 Solenoid Vana 1/2"Kay.
Danfoss 032F1214 EVR 10 Solenoid Vana 5/8"Kay.
Danfoss 032L1214 EVR 10 Solenoid Vana 5/8"Kay.
Danfoss 032L1228 EVR 15 Solenoid Vana 5/8"Kay.
Danfoss 032L1225 EVR 15 Solenoid Vana 7/8"Kay.
Danfoss 032F1240 EVR 20 Solenoid Vana 7/8"Kay.
Danfoss 032L1244 EVR 20 Solenoid Vana 1 1/8"Kay.
Danfoss 032F2201 EVR 25 Solenoid Vana 1 1/8"Kay.
Danfoss 032F2206 EVR 25 Solenoid Vana 28mmKay.
Danfoss 032L2206 EVR 25 Solenoid Vana 28mm Kay.
Danfoss 032L3267 EVR 22 Solenoid Vana 1 3/8"Kay.
Danfoss 032F2208 EVR 25 Solenoid Vana 1 3/8"Kay.
Danfoss 032L2208 EVR 25 Solenoid Vana 1 3/8"Kay.
Danfoss 032L1104 EVR 32 Solenoid Vana 1 5/8"Kay.
Danfoss 032L1106 EVR 32 Solenoid Vana 1 3/8"Kay.
Danfoss 032F8107 EVR 3 Solenoid Vana 1/4"Rak.
Danfoss 032F8116 EVR 3 Solenoid Vana 3/8"Rak.
Danfoss 032F8079 EVR 6 Solenoid Vana 1/2"Rak.
Danfoss 032F8098 EVR 10 Solenoid Vana 5/8"Rak.
Danfoss 032G1066 EVRH 10 Solenoid Vana 1/2"Kay.CO2



VANALAR

KÜRESEL VANALAR

	BAĞLANTI TİPİ
	
	3/8" 10mm Kaynaklı, pirinç gövde
	1/2" 12mm Kaynaklı, pirinç gövde
	5/8" 16mm Kaynaklı, pirinç gövde
	3/4" 18mm Kaynaklı, pirinç gövde
	7/8" 22mm Kaynaklı, pirinç gövde
	1 1/8" 28mm Kaynaklı, pirinç gövde
	1 3/8" 35mm Kaynaklı, pirinç gövde
	1 5/8" 42mm Kaynaklı, pirinç gövde
	2 1/8" 54mm Kaynaklı, pirinç gövde
	1/4" 6mm Şarzlı Tip, Kaynaklı, pirinç gövde
	3/8" 10mm Şarzlı Tip, Kaynaklı, pirinç gövde
	1/2" 12mm Şarzlı Tip, Kaynaklı, pirinç gövde
	5/8" 16mm Şarzlı Tip, Kaynaklı, pirinç gövde
	3/4" 18mm Şarzlı Tip, Kaynaklı, pirinç gövde
	7/8" 22mm Şarzlı Tip, Kaynaklı, pirinç gövde
	1 1/8" 28mm Şarzlı Tip, Kaynaklı, pirinç gövde
	1 3/8" 35mm Şarzlı Tip, Kaynaklı, pirinç gövde
	1 5/8" 42mm Şarzlı Tip, Kaynaklı, pirinç gövde
	2 1/8" 54mm Şarzlı Tip, Kaynaklı, pirinç gövde

VANALAR

ARA VANALAR

	MODEL
	
	ARA VANA RAKORLU 3 / 8
	ARA VANA RAKORLU 1 / 2
	ARA VANA RAKORLU 5 / 8
	ARA VANA RAKORLU 3 / 4

VANALAR

CHECK VALFLER

	BAĞLANTI TİPİ	BAĞLANTI UCU	BASINÇ DİFRANSİYELİ (BAR)
		RAKORLU (FLARE)	1/4
RAKORLU (FLARE)		3/8	
RAKORLU (FLARE)		1/2	
RAKORLU (FLARE)		5/8	
RAKORLU (FLARE)		3/4	
KAYNAKLI (ODS)		3/8	
KAYNAKLI (ODS)		1/2	
KAYNAKLI (ODS)		5/8	
KAYNAKLI (ODS)		3/4	
KAYNAKLI (ODS)		7/8	

VANALAR

CHECK VALFLER

	BAĞLANTI TİPİ	BAĞLANTI UCU	BASINÇ DİFRANSİYELİ (BAR)
	KAYNAKLI (ODS)	5/8	0,3
	KAYNAKLI (ODS)	7/8	0,1
	KAYNAKLI (ODS)	1 1/8	0,1
	KAYNAKLI (ODS)	1 3/8	
	KAYNAKLI (ODS)	1 5/8	
	KAYNAKLI (ODS)	2 1/8	

DRAYERLER

	KODU	BAĞLANTI	TİPİ
	D052	1/4	RAKORLU
	D052S	1/4	KAYNAKLI
	D083	3/8	RAKORLU
	D083S	3/8	KAYNAKLI
	D084	1/2	RAKORLU
	D084S	1/2	KAYNAKLI
	D163	3/8	RAKORLU
	D163S	3/8	KAYNAKLI
	D164	1/2	RAKORLU
	D164S	1/2	KAYNAKLI
	D165	5/8	RAKORLU
	D165S	5/8	KAYNAKLI
	D304	1/2	RAKORLU
	D304S	1/2	KAYNAKLI
	D305	5/8	RAKORLU
	D305S	5/8	KAYNAKLI
	D306	3/4	RAKORLU
	D306S	3/4	KAYNAKLI
	H48 Kartuş	-	KOVAN
	H48.33b.12.1 Kartuş Kovanı	1/2"	ODS 12
H48.33b.16.1 Kartuş Kovanı	5/8"	ODS 16	
H48.33b.19.1 Kartuş Kovanı	3/4"	ODS 19	
H48.33b.22.1 Kartuş Kovanı	7/8"	ODS 22	
H48.33b.28.1 Kartuş Kovanı	1 1/8"	ODS 28	
H48.33b.35.1 Kartuş Kovanı	1 3/8"	ODS 35	
H48.33b.42.1 Kartuş Kovanı	1 5/8"	ODS 42	
H48.33b.54.1 Kartuş Kovanı	2 1/8"	ODS 54	

BASINÇ PROSESTATLARI

BASINÇ OTOMATIĐI



Alçak Basınç Sivici
On : 0,5 Bar - Off : 1,50 Bar



Yüksek Basınç Sivici
On : 21 Bar - Off : 16 Bar



Fan Kontrol Sivici
On: 16 Bar - Off: 13 Bar

BASINÇ PROSESTATLARI

ELİWELL BASINÇ PROSESTATLARI



Eliwell D16P07A01MS200
Alçak Basınç Prosestat



Eliwell D16P30A01MS200
Yüksek Basınç Prosestat



Eliwell D17P30AM1MS200
Kombine Prosestat

BASINÇ PROSESTATLARI

DANFOSS BASINÇ PROSESTATLARI



Danfoss KP 1 Presostat -
Vakum



Danfoss KP 5 Presostat - Y.
B. Otom Resasla

BASINÇ PROSESTATLARI

DANFOSS BASINÇ PROSESTATLARI



Danfoss KP 5
Presostat - Y. B.Man.Reset



Danfoss KP15
Presostat-Kombine Oto.Res.



Danfoss KP15
Presostat-Kombine Oto.Res.



Danfoss KP15
Presostat-Kombine Man.Res.



Danfoss KP15
Presostat-Kombine Sinyalli

BASINÇ PROSESTATLARI

DANFOSS YAĞ OTOMATİKLERİ



Danfoss MP 54 Yağ Basınç
Kontrol- 60sn.



Danfoss MP 55 Yağ Basınç
Kontrol- 60sn.



Danfoss MP 55 Yağ Basınç
Kontrol- 90sn.

BASINÇ PROSESTATLARI

FAN HIZ KONTROL CİHAZLARI



SC20M1 Fan Hız Kontrol Cihazı



Johnson Control Fan Hız Kontrol 4A (IP65)



Johnson Control Fan Hız Kontrol 12A (IP54)

FAN VE AKSESUARLARI

AXIAL FANLAR



Model	Tipi	Voltaj	"Devir (rpm) "
YWF (K) 4E 250-Z	Emici	(230 V) 50/60 HZ	1380
YWF (K) 4E 300-Z	Emici	(230 V) 50/60 HZ	1370
YWF (K) 6E 300-Z	Emici	(230 V) 50/60 HZ	900
YWF (K) 4E 350-Z	Emici	(230 V) 50/60 HZ	1370
YWF (K) 6E 350-Z	Emici	(230 V) 50/60 HZ	930
YWF (K) 4E 400-Z	Emici	(230 V) 50/60 HZ	1350
YWF (K) 6E 400-Z	Emici	(230 V) 50/60 HZ	940
YWF (K) 4E 450-Z	Emici	(230 V) 50/60 HZ	1380
YWF (K) 6E 450-Z	Emici	(230 V) 50/60 HZ	900
YWF (K) 4E 500-Z	Emici	(230 V) 50 HZ	1320
YWF (K) 6E 500-Z	Emici	(230 V) 50 HZ	920
YWF (K) 4E 500-ZX06	Emici	(230 V) 50 HZ	1380
YWF (K) 4E 630-Z	Emici	(230 V) 50 HZ	1315
YWF (K) 6E 630-Z	Emici	(230 V) 50 HZ	930
YWF (K) 4E 300-Z-B	Üfleyici	(230 V) 50/60 HZ	1370
YWF (K) 4E 350-Z-B	Üfleyici	(230 V) 50/60 HZ	1370
YWF (K) 6E 400-Z-B	Üfleyici	(230 V) 50/60 HZ	1350
YWF (K) 4E 450-Z-B	Üfleyici	(230 V) 50/60 HZ	1380
YWF (K) 6E 500-Z-B	Üfleyici	(230 V) 50 HZ	1320
YWF (K) 4D 500-Z	Emici	380 V 50 HZ	1320
YWF (K) 4D 630-Z	Emici	380 V 50 HZ	1365
YWF (K) 6D 630-Z	Emici	380 V 50 HZ	920
YWF (K) 6D 710-Z	Emici	400 V Δ 50 HZ	900

FAN VE AKSESUARLARI

Q FANLAR

	Model	Tipi
	VN 5 - 13 Fan Motoru	42 Watt
	VN 10-20 Fan Motoru	53 Watt
	VN 18-30 Fan Motoru	70 Watt
	VN 25-40 Fan Motoru	95 Watt
	VN 34-45 Fan Motoru	120 Watt





FAN VE AKSESUARLARI

KARE FANLAR

	Model	Tipi
	Kare Fan	8x8 CM
	Kare Fan	9X9 CM
	Kare Fan	12X12 CM
	Kare Fan	17X17 CM

FAN VE AKSESUARLARI

RADYAN FANLAR

	18 cm Radyan Fan		24 cm Radyan Fan
	30 cm Radyan Fan		36 cm Radyan Fan

FAN VE AKSESUARLARI

FAN KANATLARI - ÇEMBERLERİ - KAFESLERİ

	TİPİ	ÇAP	YÖNÜ
	Fan Kanadı	154 MM	Emici
	Fan Kanadı	200 MM	Emici
	Fan Kanadı	250 MM	Emici
	Fan Kanadı	300 MM	Emici
	Fan Kanadı	200 MM	Üfleyici
	Fan Kanadı	250 MM	Üfleyici
	Fan Kanadı	300 MM	Üfleyici
	Tel Kafes	200 MM	-
	Tel Kafes	250 MM	-
	Tel Kafes	300 MM	-
	Plastik Çember	154 MM	-
	Plastik Çember	200 MM	-
	Plastik Çember	250 MM	-
	Plastik Çember	300 MM	-

LİKİT TUTUCULAR

	Model	Açıklama
	RA-205	Likit Tutucu 5/8"
	RA-207	Likit Tutucu 7/8"
	RA-211	Likit Tutucu 1 1/8"
	RA-213	Likit Tutucu 1 3/8"
	RA-215	Likit Tutucu 1 5/8"

YAĞ AYIRICILAR

	Model	Açıklama
	S-4004	Yağ Ayırıcı 1/2"
	S-4005	Yağ Ayırıcı 5/8"
	S-4007	Yağ Ayırıcı 7/8"
	S-4011	Yağ Ayırıcı 1 1/8"
	S-4013	Yağ Ayırıcı 1 3/8"

LİKİT GAZ TANKLARI

DİK LİKİT DEPO

Model	Bağlantı		Hacim
	Çelik	Bakır	Nominal Volume (lt)
01	SAE 1/4"	ODS 1/4"	1,2
	SAE 3/4"	ODS 3/8"	
02	SAE 1/4"	ODS 1/4"	1,6
	SAE 3/4"	ODS 3/8"	
03	SAE 1/4"	ODS 1/4"	1,2
	SAE 3/4"	ODS 3/8"	
04	SAE 1/4"	ODS 1/4"	1,6
	SAE 3/4"	ODS 3/8"	
11	SAE 1/4"	ODS 1/4"	2,5
	SAE 3/4"	ODS 3/8"	
12	SAE 1/4"	ODS 1/4"	2,8
	SAE 3/4"	ODS 3/8"	
13	SAE 1/4"	ODS 1/4"	3,3
	SAE 3/4"	ODS 3/8"	
14	SAE 1/4"	ODS 1/4"	3,8
	SAE 3/4"	ODS 3/8"	
15	SAE 1/4"	ODS 1/4"	4,7
	SAE 3/4"	ODS 3/8"	
21	SAE 1/4"	ODS 1/4"	5,7
	SAE 3/4"	ODS 3/8"	
22	SAE 1/4"	ODS 1/4"	6,5
	SAE 3/4"	ODS 3/8"	
23	SAE 1/4"	ODS 1/4"	7,5
	SAE 3/4"	ODS 3/8"	
31	SAE 1/4"	ODS 1/4"	9,3
	SAE 3/4"	ODS 3/8"	
32	SAE 1/4"	ODS 1/4"	12,0
	SAE 3/4"	ODS 3/8"	
33	SAE 1/4"	ODS 1/4"	15,0
	SAE 3/4"	ODS 3/8"	
34	SAE 1/4"	ODS 1/4"	20,0
	SAE 3/4"	ODS 3/8"	

LİKİT GAZ TANKLARI

YATIK LİKİT DEPO

Model	Bağlantı		Hacim
	Çelik	Bakır	Nominal Volume (lt)
21	SAE 1/2"	ODS 1/2"	5,7
	SAE 5/8"	ODS 5/8"	
22	SAE 1/2"	ODS 1/2"	6,5
	SAE 5/8"	ODS 5/8"	
23	SAE 1/2"	ODS 1/2"	7,5
	SAE 5/8"	ODS 5/8"	
31	SAE 5/8"	ODS 5/8"	9,3
	SAE 3/4"	ODS 3/4"	
	-	ODS 7/8"	
32	SAE 5/8"	ODS 5/8"	12,0
	SAE 3/4"	ODS 3/4"	
	-	ODS 7/8"	
33	SAE 5/8"	ODS 5/8"	15,0
	SAE 3/4"	ODS 3/4"	
	-	ODS 7/8"	
34	SAE 5/8"	ODS 5/8"	20
	SAE 3/4"	ODS 3/4"	
	-	ODS 7/8"	

TİTREŞİM ALICILAR

Model	Açıklama
TİTREŞİM HORTUMLARI	
MS-038	3/8" Titreşim Hortumu
MS-050	1/2" Titreşim Hortumu
MS-063	5/8" Titreşim Hortumu
MS-075	3/4" Titreşim Hortumu
MS-087	7/8" Titreşim Hortumu
MS-100	1-1/8" Titreşim Hortumu
MS-125	1-3/8" Titreşim Hortumu
MS-150	1-5/8" Titreşim Hortumu
MS-200	2-1/8" Titreşim Hortumu
MS-250	2-5/8" Titreşim Hortumu
MS-300	3-1/8" Titreşim Hortumu

GAZ GÖZETLEME CAMLARI

	Model	INC	MM	Bağlantı	Çalışma Aralığı
	MI2MM	1/4"	-	Rakorlu	-30 °C +80 °C
	MI3MM	3/8"	-	Rakorlu	
	MI4MM	1/2"	-	Rakorlu	
	MI5MM	5/8"	-	Rakorlu	
	MI6MM	3/4"	-	Rakorlu	
	MI2MF	1/4"	-	Erkek - Dişi Rakorlu	
	MI3MF	3/8"	-	Erkek - Dişi Rakorlu	
	MI4MF	1/2"	-	Erkek - Dişi Rakorlu	
	MI5MF	5/8"	-	Erkek - Dişi Rakorlu	
	MI6MF	3/4"	-	Erkek - Dişi Rakorlu	
	MI2S	1/4"	-	Kaynaklı	
	MI3S	3/8"	-	Kaynaklı	
	MIM10S	-	10	Kaynaklı	
	MIM12S	-	12	Kaynaklı	
	MI4S	1/2"	-	Kaynaklı	
	MI5S	5/8"	16	Kaynaklı	
	MIM18S	-	18	Kaynaklı	
	MI6S	3/4"	-	Kaynaklı	
	MI7S	7/8"	22	Kaynaklı	
	MI9S	1 1/8"	28	Kaynaklı	
	MI11S	1 3/8"	35	Kaynaklı	
	MI13S	1 5/8"	-	Kaynaklı	

YAĞLAR

	Model	Tür	Litre	Viskozite cSt@40 °C	Kullanım Türü
	SUNISO 3GS		4	30	R-12/R-22/R-502
	SUNISO 4GS		4	55	R-12/R-22/R-502
	SUNISO 5G		4	97,2	R-12/R-22/R-502
	SUNISO 3GS		20	30	R-12/R-22/R-502
	SUNISO 4GS		20	55	R-12/R-22/R-502
	SUNISO 5G		20	97,2	R-12/R-22/R-502
	SUNISO 3GS		205	30	R-12/R-22/R-502
	SUNISO 4GS		205	55	R-12/R-22/R-502
	SUNISO 5G		205	97,2	R-12/R-22/R-502
	SUNISO 4SA		20	57	Amonyak - NH3 - R717

YAĞLAR

	Model	Tür	Litre	Viskozite cSt@40 °C	Kullanım Türü
	SUNISO 4SA		205	57	Amonyak - NH3 - R717
	SUNISO 4.5GS		205	68	Amonyak - NH3 - R717
	SUNICE A68		20	69	Amonyak - NH3 - R717
	SUNICE A68		200	69	Amonyak - NH3 - R717
	SUNISO SL22		1	22	R-134a/R-404A/R-407C/R-410A/R-507
	SUNISO SL32		1	32	R-134a/R-404A/R-407C/R-410A/R-507
	SUNISO SL46		1	47,2	R-134a/R-404A/R-407C/R-410A/R-507
	SUNISO SL68		1	70,1	R-134a/R-404A/R-407C/R-410A/R-507
	SUNISO SL100		1	100	R-134a/R-404A/R-407C/R-410A/R-507
	SUNISO SL22		4	22	R-134a/R-404A/R-407C/R-410A/R-507
	SUNISO SL32		4	32	R-134a/R-404A/R-407C/R-410A/R-507
	SUNISO SL46		4	47,2	R-134a/R-404A/R-407C/R-410A/R-507
	SUNISO SL68		4	70,1	R-134a/R-404A/R-407C/R-410A/R-507
	SUNISO SL100		4	100	R-134a/R-404A/R-407C/R-410A/R-507
	SUNISO SL170		4	170	R-134a/R-404A/R-407C/R-410A/R-507
	SUNISO SL220		4	220	R-134a/R-404A/R-407C/R-410A/R-507
	SUNISO SL32		20	32	R-134a/R-404A/R-407C/R-410A/R-507
	SUNISO SL68		20	70,1	R-134a/R-404A/R-407C/R-410A/R-507
	SUNISO SL100		20	100	R-134a/R-404A/R-407C/R-410A/R-507
SUNISO SL22		208	22	R-134a/R-404A/R-407C/R-410A/R-507	
SUNISO SL32		208	32	R-134a/R-404A/R-407C/R-410A/R-507	
SUNISO SL46		208	47,2	R-134a/R-404A/R-407C/R-410A/R-507	
SUNISO SL68		208	70,1	R-134a/R-404A/R-407C/R-410A/R-507	
SUNISO SL100		208	100	R-134a/R-404A/R-407C/R-410A/R-507	
SUNISO SL170		208	170	R-134a/R-404A/R-407C/R-410A/R-507	
SUNISO SL220		208	220	R-134a/R-404A/R-407C/R-410A/R-507	
SUNISO AKB68		20	55	Amonyak - NH3 - R717	
SUNISO AKB100		20	95	Amonyak - NH3 - R717	
SUNISO AKB68		200	55	Amonyak - NH3 - R717	
SUNISO AKB100		200	95	Amonyak - NH3 - R717	
SUNICE EF68		200	67	CO2 - R744	
SUNISO PB100	PAG	0,3	100	R 134a (Araba Klimaları İçin - SANDEN)	
SUNISO VAKUUM PUMP OIL			1	68	Tüm Vakum Pompa Markaları İçin
			5		



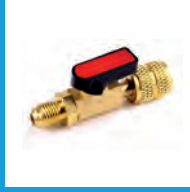
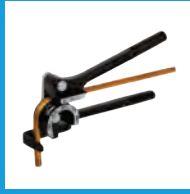

02



EL ALETLERİ



SERVİS EKİPMANLARI	96
BORU MAKASLARI	97
BORU KIVIRMA SETLERİ	98
HAVŞA TAKIMLARI	99
GAZ ŞARJ İSTASYONLARI	100
GAZ ŞARJ TERAZİLERİ	100
GAZ ŞARJ VANALARI	101
GAZ ŞARJ MANİFOLDLARI	102
GAZ ŞARJ HORTUMLARI	104
KAPİLER HORTUMLARI	105
GERİ TOPLAMA ÜNİTELERİ	107
GAZ KAÇAK DEDEKTÖRLERİ	107
VAKUM POMPALARI	108
KAYNAK EKİPMANLARI	109
ÖLÇÜ ALETLERİ	111
TERMOMETRELER	112
LEHİM MAKİNELERİ	113
YAPIŞTIRICILAR	113
TEMİZLEYİCİLER	114



EL
ALETLERİ

SERVİS EKİPMANLARI



Borulu Sibop



Borusuz Sibop



Circir Anahtarı Model 2



Refco Circir Anahtarı



Gaz Şarj Soketi



Pinc Off Pensesi



Kılcal Kesme Makası



Kılcal Kesme Makası



Kondenser Tarağı



Kondenser Tarağı



Refco Kondenser Tarağı



17 Mikron Streç Film



Kodu
Akım Koruyucu



Kodu
Akım Koruyucu Dijital Ayarlı

SERVİS EKİPMANLARI



Akım Koruyucu



Mekanik Zaman Saati



Weicon Kaçak Arama Spreyi



Pas Sökücü



Sızdırmazlık İlacı



Galoş

BORU MAKASLARI



Pm 127 Mini Boru Makası



Refco Rs 16 Boru Makası



Pm 274 Boru Makası



Refco Rs 25 Boru Makası



Value VTC 28 Boru Makası



Refco Rs 35 Boru Makası

BORU MAKASLARI



Refco Rs 42 Boru Makası - Kopya



Value VTC 42 Boru Makası



Value VTC 70 Boru Makası



Value VTT 5 Çapak Temizleme



Çapak Temizleme Aparatı

BORU KIVIRMA SETLERİ



3 lü Boru Kıvrma Seti



Boru Kıvrma Seti 404L

	MODEL
	Boru Kıvrma Spiral Yay 1/4"
	Boru Kıvrma Spiral Yay 3/8"
	Boru Kıvrma Spiral Yay 1/2"
	Boru Kıvrma Spiral Yay 5/8"
	Boru Kıvrma Spiral Yay 3/4"
	Boru Kıvrma 1/4-5/16-3/8"
	Boru Kıvrma 3/8"
	Boru Kıvrma 1/2"
	Boru Kıvrma 5/8"
	Boru Kıvrma 3/4"

HAVŞA TAKIMLARI



Ct 275 Şişirmeli Havşa Takımı



Ct 278 Şişirmeli Boru Makası Havşa Takımı



Ct 808 Torklu Havşa Takımı



Ct 195 Havşa Takımı



Ct 525 Havşa Takımı



PM 808 Torklu Havşa Takımı



Refco 275 Şişirmeli Havşa Takımı



Refco 888 Torklu Havşa Takımı



Value 808 Torklu Havşa Takımı



Spin Kolay Havşa Seti



Spin Kolay Şişirme Seti



Kollu Şişirme Seti



Şişirme Aparatı



Şişirme Aparatı

GAZ ŞARJ İSTASYONLARI



R600 Gaz Şarj Şişesi 118 Gr

Gaz Destek Ünitesi
R600-R134Terazili Gaz Destek Ünitesi
R600-R134Refco Model Gaz Destek
Ünitesi R600-R134

Gaz Şarj Şişesi 1 Kg



Gaz Şarj Şişesi 2 Kg

Gaz Şarj İstasyonu Vakum
PompalıGaz Şarj İstasyonu Vakum
Pompalı Dijital TeraziliGaz Şarj İstasyonu R600 ve
R134 Vakum Pompalı Dijital
Terazili

GAZ ŞARJ TERAZİLERİ

Elitech LMC-200 Model 100
Kg TeraziElitech LMC-300 Model 100
Kg Solenoid Vanalı Dijital
Terazi

GAZ ŞARJ TERAZİLERİ



Techsun 7020 Model Terazi



Techsun 9030 Model Solenoid Vanalı Terazi



Value VES-50A 50 Kg Terazi



Value VRS-50i-01 50 Kg Terazi Kablosuz



R600 Terazi



Refco Ref Meter Octa Plus Solenoid Vanalı Terazi



Refco Ref Meter Octa Terazi



Refco Octa Wireless Terazi

GAZ ŞARJ VANALARI



R600a Gaz Vanası



Refco R600a Gaz Vanası



Mini Küresel Vana Erkek - Dişi



R134a Gaz Vanası

GAZ ŞARJ VANALARI



Kodu

Mini Küresel Vana Erkek Erkek



Kodu

R410a Gaz Aparatı



Kodu

Araç Klima Şarj Vana Seti Düz



Kodu

Araç Klima R134 Vana Seti



Kodu

Araç Klima R1234 Vana Seti

GAZ ŞARJ MANİFOLDLARI



Pm R22-R134-R404-R410 Manifold Takımı



Testo 550S Manifold Takımı



Refco Refmate 2 Manifold Takımı



Value Manifold Dijital Isı Ölçerli



Refco R22-R134A-R404A Manifold Takımı



Refco R22-R407C-R410A Manifold Takımı

GAZ ŞARJ MANİFOLDLARI



Refco R32-R410A Manifold Takımı



Refco R407C-R134A-R404A Manifold Takımı



Value Manifold R22-R134-R404-R407



Value Manifold R32-R22-R410



Value Manifold R410-R22-R134-R407



Value Manifold R1234yf



Value R22-R134-R404-R407



Aitcool R22-R134-R404-R407



Value VMG-1-U-H Manifold Tek Yollu



Value VMG-1-U-L Manifold Tek Yollu



Pm Yüksek Basınç Manometre Saati



Pm Yüksek Alçak Manometre Saati



Value Yüksek Manometre Saati



Value Alçak Manometre Saati

GAZ ŞARJ MANİFOLDLARI



Refco M2-500-DS Yüksek
Basınç R22-134-404



Refco M2-250-DS Alçak
Basınç R22-134-404 Mano-
metre Saati



Refco Alçak Basınç R600
Manometre Saati

GAZ ŞARJ HORTUMLARI



90 Cm Gaz Hortum Seti
R22-134-404 3 Lü



90 Cm Gaz Hortum Seti
R410 3 Lü



120 Cm Gaz Hortum Seti
R22-134-404 3 Lü



120 Cm Gaz Hortum Seti
R410 3 Lü



150 Cm Gaz Hortum Seti
R22-134-404 3 Lü



150 Cm Gaz Hortum Seti
R410 3 Lü



180 Cm Gaz Hortum Seti
R22-134-404 3 Lü



180 Cm Gaz Hortum Seti
R410 3 Lü

GAZ ŞARJ HORTUMLARI



Refco 90 Cm Gaz Hortum
Seti R22-134-404 3 Lü



Refco 90 Cm Gaz Hortum
Seti R410 3 Lü



Refco 120 Cm Gaz Hortum
Seti R22-134-404 3 Lü



Refco 120 Cm Gaz Hortum
Seti R410 3 Lü



Refco 150 Cm Gaz Hortum
Seti R22-134-404 3 Lü



Refco 150 Cm Gaz Hortum
Seti R410 3 Lü



Refco 180 Cm Gaz Hortum
Seti R22-134-404 3 Lü



Refco 180 Cm Gaz Hortum
Seti R410 3 Lü



Küresel Vanalı Uzun Gaz
Hortumu

KAPİLER HORTUMLARI



101 Presli Tip Rekor



102 Presli Tip Rekor Uzun
Boy

KAPİLER HORTUMLARI



121 Presli Tip Rekor 90 Derece



141 Dişi - Dişi - Dişi Rekorsuz Tee



142 Üstten Rekorlu Tee



143 Yandan Rekorlu Tee



144 2 MM Hortumve 5 MM Hortum Kombinasyonu Tee



145 Istavroz



146 Kapiler Hortum Uzatma Aparatı



403 Kırmızı Kapiler Hortum



404 Mavi Kapiler Hortum



501 Kapiler Hortum Sıkma Pensesi



502 Kapiler Hortum Makası 890-12 MM



5021 Kapiler Hortum Makası 890-25 MM

GERİ TOPLAMA ÜNİTELERİ



Aitcool RECO 250S 1-2 Hp
Geri Toplama Cihazı



Aitcool RECO 520S 1 Hp
Geri Toplama Cihazı



Value VRC 6100i Akıllı Gaz
Dolum Cihazı



Value VRR12L-OS Geri To-
plama Cihazı



Value VRR12M r32. r1234yf
Geri Toplama Cihazı



Value VRR24M-B r32.
r1234yf Geri Toplama Cihazı



Value VRR24L-OS Geri
Toplama Cihazı



Value Geri Toplama Tüpü
61lt

GAZ KAÇAK DEDEKTÖRLERİ



Fieldpiece SRL2K7 Gaz
Kaçak Dedektörü



İnficon D-Tek Gaz Kaçak
Dedektörü



İnficon Gas Mate Yanıcı Gaz
Kaçak Dedektörü



Refco Startek Gaz Kaçak
Dedektörü

VAKUM POMPALARI



Value VE 115N Vakum Pompası



Value VE 125N Vakum Pompası



Value VE 135N Vakum Pompası



Value VE 160N Vakum Pompası



Value VE 215N Vakum Pompası



Value VE 225N Vakum Pompası



Value VE 245N Vakum Pompası



Value VE 260N Vakum Pompası



Value VE 280N Vakum Pompası



Value VE2100N Vakum Pompası



Value VI 240Y-32 Vakum Pomp.-R32-R1234yf-V.S.+S.V



Value VI 260SV Vakum Pompası-Vakum Saati+Sol.V.



1500050005 Rothenberger Tek Kademeli Vakum Pompası 1-4



Aitcool Vakum Pompası VP115 2,60 m3 Tek Kademe

VAKUM POMPALARI



Aitcool Vakum Pompası
VP130 4,30 m3 Tek Kademe



Aitcool Vakum Pompası
VP140 6,00 m3 Tek Kademe



Aitcool Vakum Pompası
VP230 4,3 m3 Çift Kademe



Aitcool Vakum Pompası
VP270 10,2 m3 Çift Kademe

KAYNAK EKİPMANLARI



6 Lt Ekonomik Oksijen
Kaynak Seti



6 Lt Lüks Oksijen Kaynak
Seti



6 Lt Lüks Oksijen Seti Aygaz
Tüplü



6 Lt Lüks Oksijen Seti Lpg
Tüplü



10 Lt Arabalı Oksijen Kaynak
Seti



6 Lt Azot Seti



6 Lt Oksijen Tüpü



Lt Azot Tüpü

KAYNAK EKİPMANLARI



Oksijen Basınç Regülatörü



Azot Basınç Regülatörü



Oksijen Kaynak Hortumu



Şaloma Seti



Bakır Kaynak Makinası Elektrikli Fan Soğutmalı



Harris Kaynak Teli



Lucas Kaynak Teli



Asa Kaynak Teli



Rothenberger Kaynak Teli



Gümüş Alaşımli Dıştan Boraklı Kaynak Teli



Alüminyum Kaynak Teli



Sentes-Bir Kaynak Teli



Orcamp Oksijen Kaynak Kartuşu 450 Gr



Orcamp Pürmüz Seti

KAYNAK EKİPMANLARI



Orcamp Pürmüz Kartuşu
227 Gr



100 Gr Boraks



250 Gr Boraks



500 Gr Boraks

ÖLÇÜ ALETLERİ



Unit Ut 203 Dijital Pense
Ampermetre



Unit Ut 33 Dijital Ölçü Aleti



Jtw 592 Dijital Pense Am-
permetre



Dm 6266 Dijital Pense Am-
permetre



MT 87 Dijital Pense Amper-
metre



Dt 9202 Dijital Ölçü Aleti



Yx 360 Analog Ölçü Aleti



Ölçü Aleti Probu

TERMOMETRELER



SL-300T



TPM-10-F



ST-1A



TPM-900



BT-2



BT-3



DST-20



DT-2



DT-7



WT-2



WT-1



WT-6

LEHİM MAKİNELERİ



Sonar Tabanca Lehim Makinesi



Kalem Lehim Makinesi



Lehim Pastası



Lehim Teli

YAPIŞTIRICILAR



Alcon Karma Yapıştırıcı



Best Epoxy Putty Karma Yapıştırıcı 40 Gr



Best Epoxy Putty Karma Yapıştırıcı 80 Gr



Sun-Fix Karma Yapıştırıcı



Evobond 502 Yapıştırıcı



Laco Yapıştırıcı



Alcon Sıvı Conta



Akfix 705 Büyük Profesyonel Hızlı Yapıştırıcı

YAPIŞTIRICILAR



Akfix 805 750 ml Çok
Amaçlı Poliüretan Köpük



Best Civata Sabitleyici BY-
043



Best Beyaz Silikon 280 Gr



Best Siyah Silikon 280 Gr

TEMİZLEYİCİLER



Sitresson Çok Amaçlı Tüm
Yüzeylerin Temizliği 1 Kg



Sitrett Mx Endüstriyel Ultra
Konsantre Çok Amaçlı Temi-
zleyici 5 Kg



Sitrett Mx1 Eco Çok Amaçlı
Temizleyici 5 Kg



Sitrett Mx1 Eco Çok Amaçlı
Temizleyici 700Gr



Sitrett Mx3 Pro Çok Amaçlı
Temizleyici 5 Kg



Sitrett Mx3 Pro Çok Amaçlı
Temizleyici 700gr



Sitrett Mx5 Premium Çok
Amaçlı Temizleyici 5 Kg



Sitrett Mx5 Premium Çok
Amaçlı Temizleyici 700gr

TEMİZLEYİCİLER



Sitrett Ne'zoru 9218 Alkol İçerikli El, Alet ve Yüzey Temizleme Solüsyonu 1kg



Sitrett Ne'zoru 9218 Alkol İçerikli El, Alet ve Yüzey Temizleme Solüsyonu 5kg



Sitrett Ne'zoru AKL70 Alkol Bazlı El, Alet ve Yüzey Temizleme Solüsyonu 100ml



Sitrett Ne'zoru Çok Amaçlı Tüm Yüzeylerin Temizliği 1Kg



03



ENDÜSTRİYEL BUZDOLABI

ALÜMİNYUM VE AKSESUARLARI	118
PVC SACLAR	121
POLİÜRETANLAR	123
AYDINLATMA	124
STOR PERDELER	127
KAPI CONTALARI	128
AYAKLAR	130
KAPI MENTEŞELERİ	130
KAPI KİLİTLERİ	131
KUMANDA PANOLARI	131
PASTA REYONU KOLLARI	132
BUZ MAKİNESİ YEDEK PARÇALARI	133
ŞERBETLİK YEDEK PARÇALARI	133



ENDÜSTRİYEL BUZDOLABI

ALÜMİNYUM VE AKSESUARLARI



Amortisör Kolu

Çiftli Amortisör
Üst KovanTekli Amortisör
Üst Kovan

Amortisör



Z-Kol









L-kol

Çiftli Amortisörlü
Kol Alt Bağlantı
Takozu (Ayarlı)Tekli Amortisörlü
Kol Alt Bağlantı
Takozu (Ayarlı)

Çene Takımı

Gold 22,5
KolJava Kol
OvalJava
Braçol KoluPlatinyum
Düz Kol1113
Önden Destekli
Amortisör Kol

ALÜMİNYUM VE AKSESUARLARI

	Amortisör Kovan Toplama Pimi		7004 Pvc yan kapak
	7002 E Metal Yan Kapak		4103 B - 4103 C Metal Yan Kapak
	4103 A Metal yan Kapak		4101 Yan Kapak
	7002 Yan Kapak		2117 A Dolap Kulpu
	Dik Dolap Kulpu		2117 A Köşe Takımı
	L-Z Kol Bağlantı Takımı		Rulman Sabitleme Pulu
	7005 B Tekli Rulman		7005 B Çiftli Rulman

ALÜMİNYUM VE AKSESUARLARI

**7005**

Köşe Bağlantısı

Bükümlü Destek
ŞişiDüz Destek
Şişi**SM 1014 T**

Köşe



Florasan Tutamağı



Su Tahliye Tapası

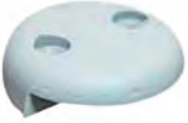

Yan Cam Klips

Cam Cama
Rulman**SKM 28 YL-YR**Sütlük Üsten Askı
Rulmanı**7005 C**Köşe e Rulman
TakımıDik Dolap Askılı
Sürgü Rulman
TakımıDik Dolap
RulmanıDik Dolap
Çift Teker

Küpeste Dikmesi

ALÜMİNYUM VE AKSESUARLARI



Klima Kasa Köşesi

30'luk, 40'luk, 50'luk
7010 - 7007 - 7008



Braçol Tapası

Dik Dolap
Dikme TırnağıNaturel- Parlak-Krom
Braçol
35cm - 45cm
40cm - 50cm15cm - 20cm
25cm - 30cm
35cm - 40cm
45cm - 50cm - 55cm25'lik Boru Babası Kapalı
25 'lik Boru Babası Açık

Oval Cam Tutamağı



30'luk Tapa



30'luk Flanş

PVC SACLAR





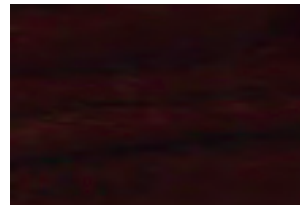





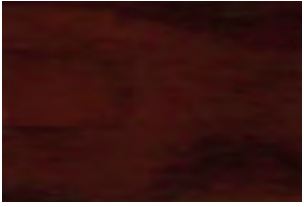
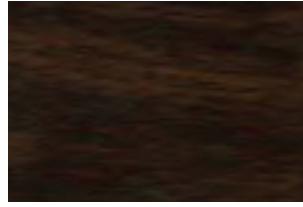

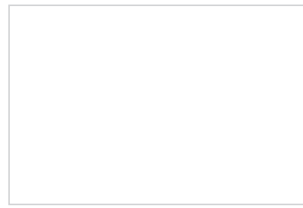

1,25 X 2,00 Paslanmaz Sac



AD-1

PVC SACLAR

	AD-1A		AD-2
	AD-3		AD-4
	AD-5		ARB1
	ASG-1		MSG-2
	MSK-1		MSK-3
	ASK-1		MSS-1
	ASM-1		MSY-1

PVC SACLAR



ASY-1

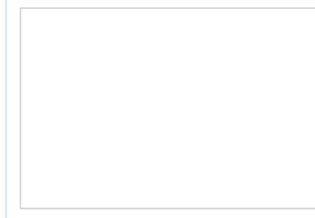

PB-1



PG1



PS-1



PS-2



PK-1



SS-1

POLİÜRETANLAR



Izosiyanat Mdi 50 Kg



Izosiyanat Mdi 250 Kg



Polyol System 1122-28 50 Kg



Polyol System 1122-28 250 Kg

AYDINLATMA

PANEL VE ŞERİT LEDLER



Siva Üstü Led Panel 12W



Siva Üstü Led Panel 20W

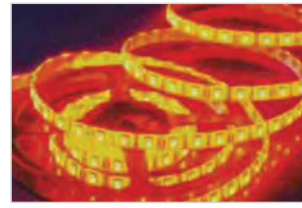
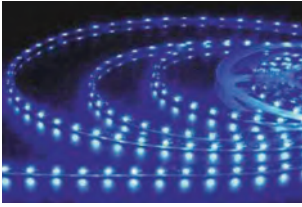

Siva Üstü Led Panel 30W

Tek Çip 60 Ledli İç Mekan
Şerit Ledler 12VTek Çip 60 Ledli Dış Mekan
Şerit Ledler 12VÜç Çip 60 Ledli İç Mekan
Şerit Ledler 12VÜç Çip 60 Ledli Dış Mekan
Şerit Ledler 12V5630 İç Mekan Yüksek
Lümenli Şerit Ledler 12V5630 Dış Mekan Yüksek
Lümenli Şerit Ledler 12V

Led Bar 5630 12V

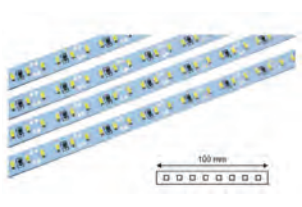

Led Bar 4014 12V



Neon Hortum Led 220V



Üç Çip Şerit Ledler 220V



RGB Led Kontrolör 6 Amper

AYDINLATMA

LED KONTRÖLERLER



RGB Led Kontrolör 20 Amper



RGB Led Kontrolör 24 Amper



RGB Led Kontrolör 18 Amper



Led Yükseltici 12 Amper



Led Yükseltici 24 Amper



Avize Kumandası



Avize Kumandası



Avize Kumandası

AYDINLATMA

ADAPTÖRLER



Metal Kasa 35W



Metal Kasa 60W



Metal Kasa 120W



Metal Kasa 150W

AYDINLATMA

ADAPTÖRLER



Metal Kasa 200W



Metal Kasa 250W



Metal Kasa 350W



Metal Kasa 500W



Ince Kasa 60W



SM 1014 T

Ince Kasa 120W



Ince Kasa 150W



Ince Kasa 200W



Ince Kasa 250W



Ince Kasa 320W

AYDINLATMA

ARMATÜRLER



Ledli Bant Armatür 6W



Ledli Bant Armatür 9W

AYDINLATMA

ARMATÜRLER



Ledli Bant Armatür 14W



Ledli Bant Armatür 18W



Ledli Bant Armatür 20W

STOR PERDELER



70 CM STOR PERDE



80 CM STOR PERDE



90 CM STOR PERDE



100 CM STOR PERDE



110 CM STOR PERDE



120 CM STOR PERDE

KAPI CONTALARI

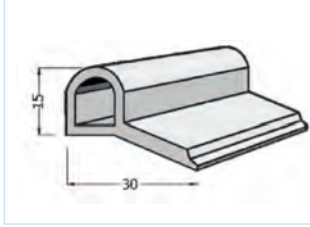

i-755

Conta

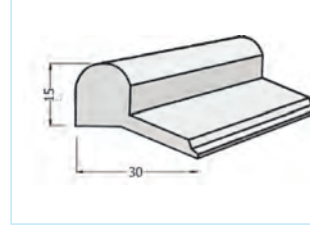

i-755-A

Conta

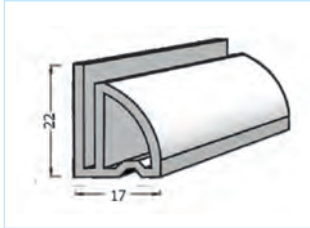

i-755-B

Conta

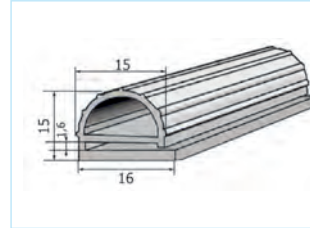

i-755-C

Conta

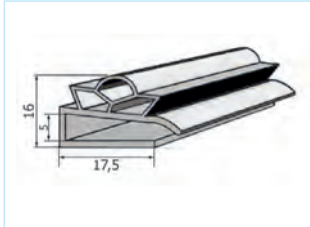

i-755-F

Conta



i-P194

Conta

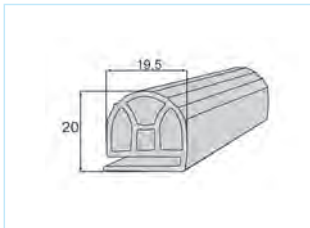

i-LS11

Conta

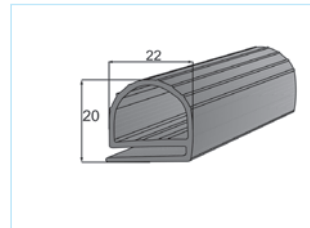

i-LS12

Conta

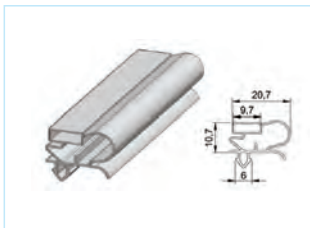

i-BMP-01

Conta

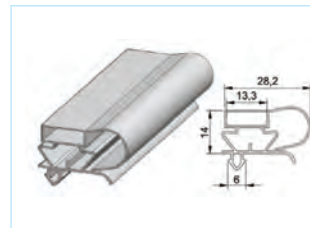

i-BMP-02

Conta

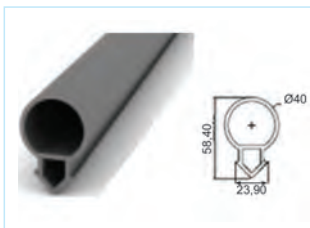

i-BMP-03

Conta

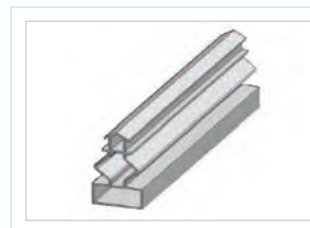

i-BMP-04

Conta

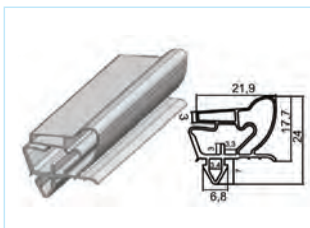

i-BMP-05

Conta

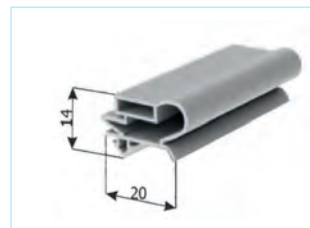

i-755-G

Klasik Conta/Classic Gasket

KAPI CONTALARI

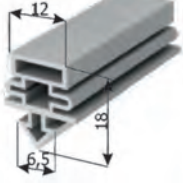

İ-TP 06

Geçmeli Conta

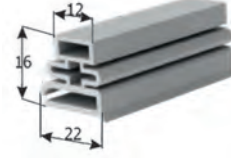

İ-TP 101

Klasik Conta

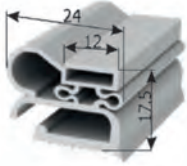

İ-TP 02

Körüklü Conta

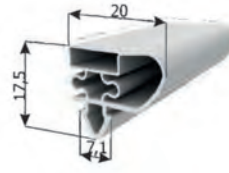

İ-TP 13

Geçmeli Körüklü Conta

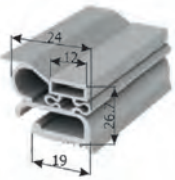

İ-TP 03

Extra Conta/

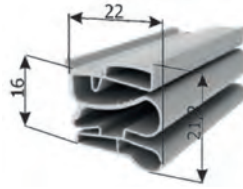

İ-TP 14

Reu-Ter Çift Körüklü

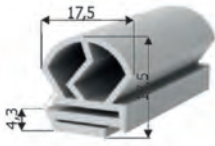

İ-TP 107

Özel Soğutucu Conta/

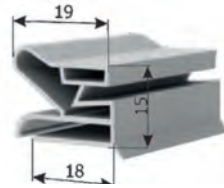

İ-TP 04

Eko Conta/

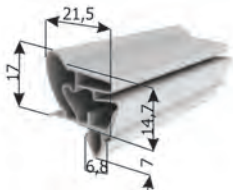

İ-TP 15

Reu-Ter G

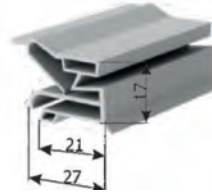

İ-TP 05

Orjinal Conta/

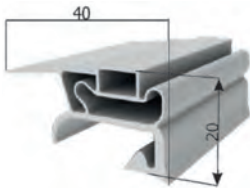

İ-TP 18

Tırnaklı Extra Conta

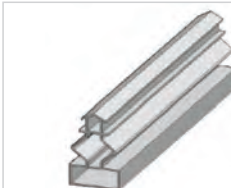

İ-TP 108

Sefa Conta

AYAKLAR



I-193-P Ayarlı Plastik
Buzdolabı Taban Ayağı



I-193 Döküm Buzdolabı
Taban Ayak



i-31-03 Rotil Ayak



I-193-P1 Plastik Buzdolabı
Taban Ayak

KAPI MENTEŞELERİ



i-07
Vitrin Mentеше



i-05
Pres Mentеше



i-111
Yan Mentеше



i-12
Yaprak Mentеше



i-13
Sıfır Havuz Mentеше



i-15
Kuru Havuz Mentеше



i-36
Havuz Mentеше



i-130
Havuz Mentеше

KAPI KİLİTLERİ



i-06

Otomatik Kilit



i-25

Büyük Otomatik Kilit



i-01-sk

Yan Kilit



i-01

Anahtarlı Yan Kilit



i-100

Uzun Yan Kilit

KUMANDA PANOLARI



Tek Şalterli Dijital Kumanda Panosu



Tek Şalterli Analog Kumanda Panosu



İki Şalterli Dijital Kumanda Panosu



Üç Şalterli Dijital Kumanda Panosu



İki Şalterli Pano Üstü Kumanda



Üç Şalterli Pano Üstü Kumanda

PASTA REYONU KOLLARI



40 Cm Pasta Kolu Parlak



40 Cm Pasta Kolu Siyah



45 Cm Pasta Kolu Parlak



45 Cm Pasta Kolu Siyah



50 Cm Pasta Kolu Parlak



50 Cm Pasta Kolu Siyah



55 Cm Pasta Kolu Parlak



55 Cm Pasta Kolu Siyah



60 Cm Pasta Kolu Parlak



60 Cm Pasta Kolu Siyah



200 Cm Pasta Kolu Dikme Parlak



200 Cm Pasta Kolu Dikme Siyah

BUZ MAKİNESİ YEDEK PARÇALARI



Çark



Disk

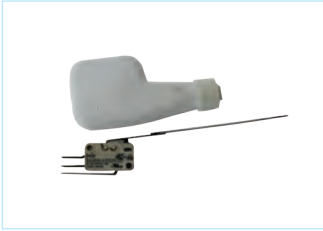

Şamandıra Grubu

ŞERBETLİK YEDEK PARÇALARI



Şerbetlik Musluk Beyaz



Şerbetlik Musluk Gri



Şerbetlik Salyangoz



Boğaz Contası



04

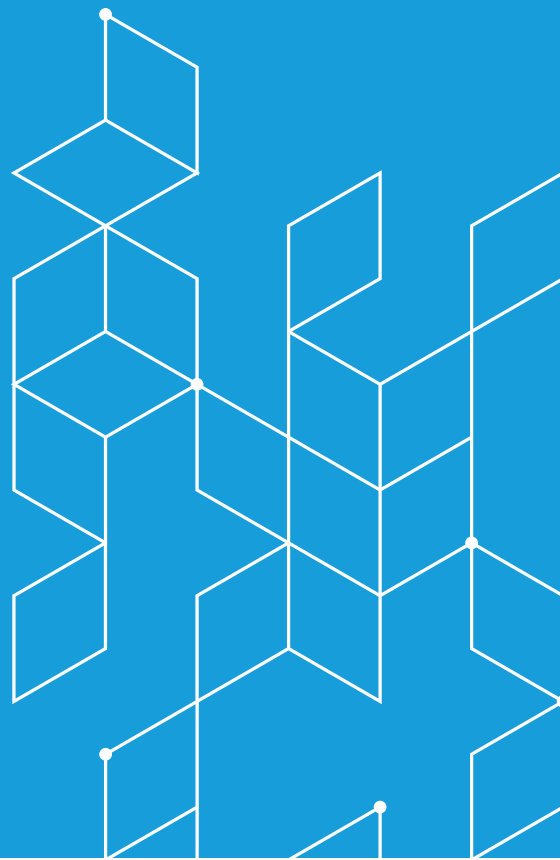

EV TİPİ BUZDOLABI

TERMOSTATLAR	136
DEFROST TIMER	137
ELEKTRONİK KARTLAR	137
BİMETAL - TERMAL SİGORTA - SENSÖR	139
TERMOSTOP GRUPLARI	
FAN MOTORLARI	141
DRAYERLER	142
KAPI BUTONLARI	143
KAPI KOLLARI	144
KAPI CONTALARI	145
BÜRO TİPİ BUZDOLABI MUSLUKLARI	146
KONDANSATÖRLER	147
MENTEŞELER	147
ISITICILAR	148
AMPÜLLER	150
RÖLE VE TERMİKLER	151
AKSESUARLAR	151

TERMOSTATLAR



Termostat Ranco K60 1029
(Tek Kapı)



Termostat Ranco VT9 120
Cm (Çift Kapı DD.)



Termostat Ranco VT92 200
Cm (Çift Kapı DD.)



Termostat Ranco K54 1168
(Deep Freeze)



Termostat Ranco K50 1125
(Vitrin)



Termostat Ranco K50 1126
(Dondurma)



Termostat Ranco K50 1127
(Havuz)



422030385

Arçelik K57-P2078 Ranco
Termostat



4121800500

Arçelik Isıtıcı Termostat



9002761100

Arçelik K60-L2151 Termostat



32000597

Vestel Termostat



91622

Ariston Indesit DD.
Termostat



172494

172494 Ariston Indesit DD.
Termostat

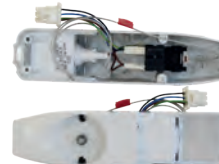

Üniversal AT Kutusu
Termostatlı

DEFROST TİMER



4390070185

Arçelik Elektronik Timer



4365600185

Arçelik Elektronik Timer



20850271

Vestel Elektronik Timer



Arçelik Defrost Timer Model 1



Arçelik Defrost Timer Model 2

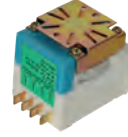

Bosch Vestel Defrost Timer



Ariston Indesit Defrost Timer

ELEKTRONİK KARTLAR



4338950185

Arçelik Kontrol Kartı



4338960185

Arçelik Potans Kartı



4360621085

Arçelik Kontrol Kartı



4360620785

Arçelik Kontrol Kartı

ELEKTRONİK KARTLAR



4360621085

Arçelik Kontrol Kartı



4360621685

Arçelik Kontrol Kartı



43606306285

Arçelik Potans Kartı



4326990485

Arçelik Kontrol Kartı



4326990185

Arçelik Kontrol Kartı



93956

Ariston Kontrol Kartı



4628150100

Altus Derin Dondurucu Kart



C00258771

Ariston Kontrol Kartı



32017855

Vestel Buzdolabı Besleme Kartı



32021666

Vestel Potans Kartı



Bosch Yeni Tip Kontrol Kartı



Bosch Ksu Uzun Kart



Bosch Ksu Kısa Kart

BİMETAL-TERMAL SİGORTA-TERMOSTOP GRUPLARI



4150320200

Arçelik Bi Metal



4150320185

Arçelik Bi Metal



4231360100

Arçelik Bi Metal



Ariston Bi Metal



Ariston Yeni Tip Bi Metal



Bi metal Termostat L60-20F



6-Bi Metal Termostat L70-20F



Arçelik Bi Metal 4 Soket



19688

Ariston Bi Metal



4216600185

Arçelik Sensör



4216600285

Arçelik Sensör



4216600385

Arçelik Sensör



4216600400

Arçelik Sensör



4216610385

Arçelik Sensör

BİMETAL-TERMAL SİGORTA-TERMOSTOP GRUPLARI



4216610485

Arçelik Sensör



4298520185

Arçelik Sensör



4394590185

Arçelik Sensör



4394720185

Arçelik Sensör



4394720285

Arçelik Sensör



Bosch KSU Sensör



Bosch Yeni Tip Sensör



Samsung Sensör.jpg



Arçelik Termal Sigorta



4236200885

Arçelik Termal Sigorta



Samsung Termostop



Termostop



Termostop



Termostop

BİMETAL-TERMAL SİGORTA-TERMOSTOP GRUPLARI



Termistop Model 4



Ariston Nf Sensör

FAN MOTORLARI



4144890201

Arçelik İç Fan Motoru



4144890301

Arçelik İç Fan Motoru



4305640185

Arçelik İç Fan Motoru



4305640585

Arçelik İç Fan Motoru



4858330185

Arçelik Fan Kanat 120 mm



4858340185

Arçelik Fan Kanat 145 mm



0222

Bosch İç Fan Motoru Model 8



0209

İç Fan Model Freezer



0214

İç Fan Motoru DC 9.75 V Model 10



İç Fan Motoru Kartlı Ebm Model 11

FAN MOTORLARI



0208

İç Fan Motoru Mini Model 2



0201

İç Fan Motoru Model 1



4151840485

İç Fan Motoru Model 5
(0220)

İç Fan Pervanesi



0202

Üniversal Ayaklı Dış Fan
Motor Grubu

0212

Üniversal Ayaksız Dış Fan
Motoru (0212)

0201

Üniversal Yeni Tip Dış Fan
Motoru

DRAYERLER

İtalyan 13.5 gr Vakumlu
Drayer

İtalyan 13.5 gr Drayer



İtalyan 15 gr Drayer



İtalyan 20 gr Drayer

DRAYERLER



İtalyan 30 gr Drayer 6.35 - 2.50



İtalyan 30 gr Drayer 6.35 - 6.35



İtalyan 40 gr Drayer



İtalyan 50 gr Drayer

KAPI BUTONLARI

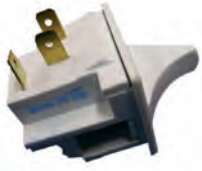

3 Soket Kapı Butonu



3 Soket Model 2 Kapı Butonu



3 Soket Model 3 Kapı Butonu



3 Soket Model 4 Kapı Butonu



2 Basmalı 3 Soket Kapı Butonu



2 Basmalı 4 Soket Kapı Butonu



2 Soket Kapı Butonu



2 Soket Model 2 Kapı Butonu

KAPI BUTONLARI



4 Soket Kapı Butonu



4 Soket Model 2 Kapı Butonu



Şişe Soğutucu Kapı Butonu

KAPI KOLLARI



4079820400

Arçelik Dondurucu Kolu



4244510100

Arçelik Dondurucu Kol İç Plastiği



4246420110

Arçelik Kapı Kolu



4250630110

Arçelik Kapı Kolu



4323290100

Arçelik Üst Kapı Kolu



4326390100

Arçelik Alt Kapı Kolu



40019017

Vestel Dondurucu Kapı Kolu



Bosch Tek Delikli Uzun Kapı Kolu

KAPI KOLLARI



Bosch 3 Delikli Uzun Kapı Kolu



Aeg Profilo Lük Kapı Kolu



Aeg Profilo Kapı Kolu Beyaz



Aeg Profilo Kapı Kolu Siyah



Dondurucu Kapı Kolu



Uğur Derin Dondurucu Kapı Kolu

KAPI CONTALARI



4324850300

Arçelik Alt Kapı Contası



4937731800

Arçelik Üst Kapı Contası

Bosch Geçmeli Kapı Contası
67,5x40Bosch Geçmeli Kapı Contası
67,5x155Bosch Geçmeli Kapı Contası
67,5x128Bosch Geçmeli Kapı Contası
67,5x115

KAPI CONTALARI



Bosch Geçmeli Kapı Contası
67,5x55



4324850100

Arçelik Üst Kapı Contası



4324852400

Arçelik Alt Kapı Contası



4937731500

Arçelik Alt Kapı Contası

BÜRO TİPİ BUZDOLABI MUSLUKLARI



Büro Tipi Kırmızı Musluk Dişi



Büro Tipi Mavi Musluk Dişi



Büro Tipi Mavi Musluk Erkek



Büro Tipi Kırmızı Musluk
Erkek

KONDANSATÖRLER

	AÇIKLAMA
	43-53MFD
	53-64MFD
	64-77MFD
	88-108MFD
	108-130MFD
	124-149MFD
	130-156MFD
	145-175MFD
	161-193MFD
	189-227MFD
	216-259MFD
	233-280MFD
	280-333MFD

MENTEŞELER

	Ugur Dondurucu Mentеше		Aeg Üst Mentеше Geniş
	Aeg Üst Mentеше İnce		Bosch Orta Mentеше Model 2

MENTEŞELER



Bosch Orta Mentеше



Ariston Vestel Alt Mentеше



Vestel Üst Mentеше



Menteşe Yuvası İnce



Menteşe Yuvası Kalın

ISITICILAR



32006025

Vestel Tahliye Isıtıcı

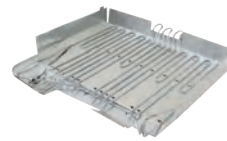

770376

Bosch 60'lık Ara Bölme Isıtıcı



770377

Bosch 60'lık Ara Bölme Isıtıcı



4322740185

Arçelik Damlalık Isıtıcı



4348060185

Arçelik Üst Damlalık Isıtıcı



4348170186

Arçelik Alt Damlalık Isıtıcı

ISITICILAR

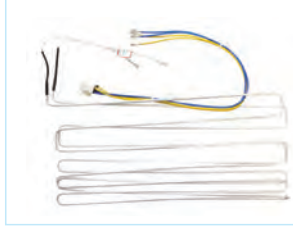

271385

Ariston Hotpoint Evap Isıtıcı
ve Sigorta

4212771300

Arçelik Folyo 10 lu Paket



4825050185

Arçelik Ara Bölme Isıtıcı



4254090385

Ara Bölme Isıtıcı

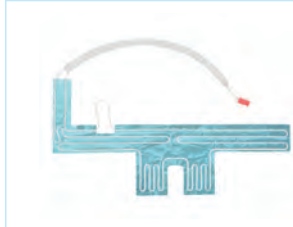

4218950100

Arçelik Ara Bölme Isıtıcı



4870840185

Arçelik Tahliye Isıtıcı



4809590100

Arçelik Tahliye Isıtıcı



4296520100

Arçelik Tahliye Isıtıcı



4295200100

Arçelik Ara Bölme Isıtıcı



4295190100

Arçelik Tahliye Isıtıcı



4848310185

Arçelik Tahliye Isıtıcı



4295220100

Arçelik Tahliye Isıtıcı



4231640100

Arçelik Ara Bölme ve Tahliye
Isıtıcı

4123990201

Arçelik Evap Isıtıcı

ISITICILAR

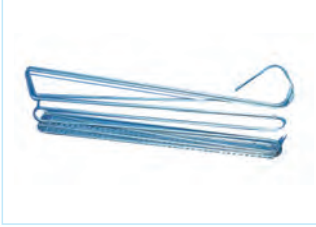

4123990301

Arçelik Evap Isıtıcı



174442

Hotpoint Ariston Oluk Isıtıcı



277213

Hotpoint Ariston Oluk Isıtıcı

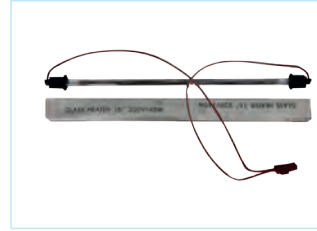

Samsung 15 İnç Cam Tüp Isıtıcı



10 İnç Cam Tüp Isıtıcı



13 İnç Cam Tüp Isıtıcı



17 İnç Cam Tüp Isıtıcı



20 İnç Cam Tüp Isıtıcı

AMPÜLLER



15W Nf Ampul



5760500100

Led Ampul 220 V E14

RÖLE VE TERMİKLER



4 Soket Ptc Röle



4 Soket Ptc Röle



Ptc Termik



Danfoss Ptc Röle Grubu



Danfoss Sargılı Röle Grubu



Embraco Bendix Röle

AKSESUARLAR



Bosch Buzdolabı Sifon 609701



Arçelik Buharlaştırma Kapağı Yapıştırıcı



Uğur Su Sebili Temizleme Solüsyonu 20 ml 10 Ad



Uğur Su Sebili Temizleme Solüsyonu 5 Ad



Best Elite Beyaz Eşya Sprey Boya Siyah 400 ml



Best Elite Beyaz Eşya Sprey Boya Beyaz 400 ml

AKSESUARLAR



708026

Bosch 60'lık Strafor



707635

Bosch 70'lık Strafor

Sistem Temizleme Tazint
Suyu

9197061833

Buzdolabı İç Yüzey
Temizleyici 500 ml

192872

Ariston Kılcal Boru



Universal Kılcal Boru



4940020200

Arçelik Sensör Değişim
Levhası Beyaz

4940020200

Arçelik Sensör Değişim
Levhası Gri

Buzdolabı Kapı Alt Sacı 10 Cm

Buzdolabı Kapı Alt Sacı 30
CmBuzdolabı Kapı Alt Sacı 60
Cm.jpgBuzdolabı Kapı Alt Sacı 70
Cm

Kompresör Takoz Lastiği



Buzdolabı Ayak

AKSESUARLAR



Mini Bar Isıtıcı 12V



Mini Bar Isıtıcı 220V



Kompresör Buharlaşma Kabı



Brennenstuhl Tekli Akım Korumucu Priz



R134 Kompresör Yağı 1 Lt



4322040400

Arçelik Kondenser Gr.



05

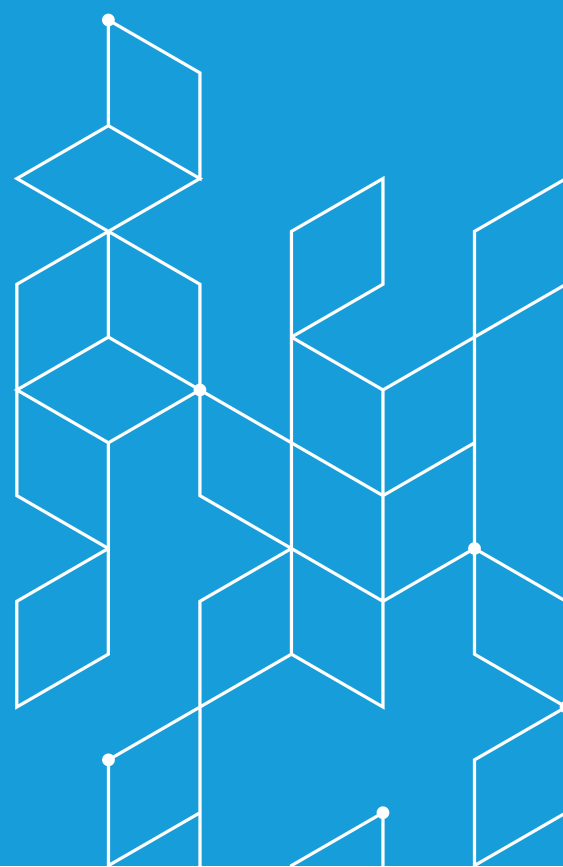

HAVA PERDELERİ



ISITICISIZ
ISITICILI

156
157



HAVA PERDELERİ

HAVA PERDELERİ

ISITICISIZ



Doublee FM-1209S2Y 90
Cm Isıtıcısız Hava Perdesi



Doublee FM-1210S2Y 100
Cm Isıtıcısız Hava Perdesi



Kodu
Doublee FM-1212S2Y 120 Cm
Isıtıcısız Hava Perdesi



Kodu
Doublee FM-1215S2Y 150 Cm
Isıtıcısız Hava Perdesi



Kodu
Doublee FM-1218S2Y 180
Cm Isıtıcısız Hava Perdesi



Kodu
Doublee FM-1220S2Y 200
Cm Isıtıcısız Hava Perdesi

HAVA PERDELERİ

ISITICILI



Doublee FM-1209S2-3DY 90
Cm Isitcılı Hava Perdesi



Doublee FM-1210S2-3DY 100
Cm Isitcılı Hava Perdesi



Doublee FM-1212S2-3DY 120
Cm Isitcılı Hava Perdesi



Doublee FM-1215S2-3DY 150
Cm Isitcılı Hava Perdesi



Doublee FM-1218S2-3DY 180
Cm Isitcılı Hava Perdesi



Doublee FM-1220S2-3DY
200 Cm Isitcılı Hava Perdesi



06



ELEKTRİK VE PANO MALZEMELERİ

KABLOLAR	160
ANAHTARLAR	161
PAKET ŞALTERLER	163
SİNYAL LAMBALARI	163
SİGORTALAR	164
KONTAKTÖRLER	165
RÖLELER	166
MEKANİK ZAMAN SAATLERİ	166
TERMİKLER	167
KLEMENSLER	167
PANOLAR	168
KABLO KANALLARI	169
KABLO BAĞLARI	169
SOKETLER	170
MAKARONLAR	170

KABLolar



Kablo 2x0,75 Kordon 100 mt



Kablo 2x0,75 TTR 100 mt



Kablo 2x1,00 TTR 100 mt



Kablo 2x1,50 TTR 100 mt



Kablo 3x1,50 TTR 100 mt



Kablo 3x2,50 TTR 100 mt



Kablo 4x0,75 TTR 100 mt



Kablo 4x1,50 TTR 100 mt



Kablo 4x2,50 TTR 100 mt



Kablo 5x1,50 TTR 100 mt



Kablo 5x2,50 TTR 100 mt



Kablo 7x1,50 TTR 100 mt

Fişli Süpürge Kablosu Yassı
Tip 5 Mt GRIFişli Süpürge Kablosu
Standart Tip 5 Mt

KABLOLAR



Çalıştırma Kablosu 3x1,50
200 MM



Ütü Kablosu 2.5 Mt Silikonlu

ANAHTARLAR



Tekli Kırmızı Geniş Işıklı Anahtar



Tekli Sarı Geniş Işıklı Anahtar



Tekli Yeşil Geniş Işıklı Anahtar



Tekli Işıklı İnce Anahtar



Tekli Işıksız İnce Anahtar



İkili Işıklı Anahtar



Üçlü Işıklı Anahtar



Mini Işıksız Anahtar



Mini Kırmızı Işıklı Anahtar



Mini Sarı Işıklı Anahtar

ANAHTARLAR



Mini Yeşil Işıklı Anahtar



2 Konumlu Mini Anahtar



Mini Işıklı Oval Anahtar



Yuvarlak Mini Işıklı Anahtar



Mini Işıklı Anahtar



Yuvarlak Mini Anahtar



Yuvarlak 2 Konumlu Mini Anahtar



2 Konumlu Geniş Anahtar



2 Konumlu Geniş Yaylı Anahtar



2 Konumlu Mini Fırın Anahtarı



Çevirmeli Anahtar



Çevirmeli Polyemit Anahtar



Çevirmeli Porselen Anahtar



Ters Sivic

PAKET ŞALTERLER



TİPİ

- 1 Faz 6-8-10 Amper Aç-Kapa Şalter
- 1 Faz 10-16-20-25 Amper Aç-Kapa Şalter
- 1 Faz 16-20-25-32 Amper Aç-Kapa Şalter
- 1 Faz 40-50-63-80 Amper Aç-Kapa Şalter
- 1 Faz 100-125-160-250-315 Amper Aç-Kapa Şalter
- 3 Faz 6-8-10 Amper Aç-Kapa Şalter
- 3 Faz 10-16-20-25 Amper Aç-Kapa Şalter
- 3 Faz 16-20-25-32 Amper Aç-Kapa Şalter
- 3 Faz 40-50-63-80 Amper Aç-Kapa Şalter
- 3 Faz 100-125-160-250-315 Amper Aç-Kapa Şalter



TİPİ

- 11-1 Faz 10-16-25 Amper Enversör Şalter
- 12-1 Faz 16-25-32 Amper Enversör Şalter
- 13-1 Faz 40-63-80 Amper Enversör Şalter
- 14-1 Faz 100-125-160-250-315 Amper Enversör Şalter
- 15-3 Faz 10-16-20-25 Amper Enversör Şalter
- 16-3 Faz 16-25-32 Amper Enversör Şalter
- 17-3 Faz 40-63-80 Amper Enversör Şalter
- 18-3 Faz 100-125-160-250-315 Amper Enversör Şalter

SİNYAL LAMBALARI



22 mm Kırmızı Sinyal Lambası



22 mm Sarı Sinyal Lambası



22 mm Yeşil Sinyal Lambası



22 mm Ses İkazlı Led Sinyal Lambası 220 V

SİNYAL LAMBALARI



10 mm Sinyal Lambası
Kırmızı 220 V



10 mm Sinyal Lambası Sarı
220 V



10 mm Sinyal Lambası Yeşil
220 V



22 mm Led Voltmetre
Kırmızı 220 V



22 mm Led Volt-Amper
Metre Kırmızı 220 V



22 mm Led Volt-Amper
Metre Sarı 220 V



22 mm Led Volt-Amper
Metre Yeşil 220 V

SİGORTALAR



Schneider EZ9F43110 1P-C10
Sigorta



Schneider EZ9F43116 1P-C16
Sigorta



Schneider EZ9F43120 1P-
C20 Sigorta



Schneider EZ9F43125 1P-
C25 Sigorta

SİGORTALAR



Schneider EZ9F43132 1P-
C32 Sigorta



Schneider EZ9F43316 3P-
C16 Sigorta



Schneider EZ9F43320 3P-
C20 Sigorta



Schneider EZ9F43332 3P-
C32 Sigorta



Schneider EZ9F43340 3P-
C40 Sigorta



Schneider EZ9F43350 3P-
C50 Sigorta

KONTAKTÖRLER



ABB B6-30-10-80 9A Mini
Kontaktör



ABB B7-30-10-80 12A Mini
Kontaktör



Schneider LC1E0910M5
EasyPact Tvs 9A Kontaktör



Schneider LC1E1210M5
EasyPact Tvs 12A Kontaktör



Schneider LC1E1810M5
EasyPact Tvs 18A Kontaktör



Schneider LC1E2510M5
EasyPact Tvs 25A Kontaktör

KONTAKTÖRLER



Schneider LC1E3210M5
EasyPact Tvs 32A Kontaktör



Schneider LC1E40M5
EasyPact Tvs 40A Kontaktör

RÖLELER



Entes GKRC-M2 Voltaj Koru-
ma Rölesi



Entes GKRC-O2 Voltaj Koru-
ma Rölesi



Entes MCB-9 Zaman Rölesi



Entes MK-01 Faz Koruma
Rölesi



Entes MKS-01 Faz Koruma
Rölesi



Entes MKS-03 Faz Koruma
Rölesi

MEKANİK ZAMAN SAATLERİ



ACK AY26-00010

Rezervli W Otomat Tipi
Mekanik Zaman Saati

TERMİKLER

Schneider LRE08 2.5-4A
Termik RölesiSchneider LRE10 4-6A
Termik RölesiSchneider LRE14 7-10A
Termik RölesiSchneider LRE16 9-13A
Termik RölesiSchneider LRE21 12-18A
Termik RölesiSchneider LRE22 16-24A
Termik RölesiSchneider LRE32 23-32A
Termik Rölesi

KLEMENSLER



W Otomat Rayı Delikli 1 Mt



Ray Klemensi 4 No Siyah



Ray Klemensi 4 No Kırmızı



Ray Klemensi 4 No Mavi

KLEMENSLER



Ray Klemensi 4 No Yeşil



Ray Klemensi 4 No Gri

Ray Klemensi 4 No
Kahverengi

Ray Klemensi 4 No Sarı

PANOLAR

Dijital Kumanda Panosu İki
ŞalterliDijital Kumanda Panosu Üç
Şalterli

Abs Tipi Pano 250x330x130



Abs Tipi Pano 300x400x170



Abs Tipi Pano 350x500x220

Abs Tipi Pano
400x600x200

Pano Yaylı Kilit



Pano Yaprak Mentеше 50x50

PANOLAR



Kodu

Pano Yaprak Menteşe
40x40



Kodu

Kaçak Akım Korumalı
Volmetre Ampermetre Test
Panosu

KABLO KANALLARI



ÖLÇÜ	RENK
20X10	Beyaz
25x25	Beyaz
30x10	Beyaz
30x16	Beyaz
30x25	Beyaz
40x16	Beyaz
40x25	Beyaz
40x40	Beyaz
60x40	Beyaz
60x60	Beyaz
80x40	Beyaz
80x60	Beyaz
100x40	Beyaz
100x60	Beyaz
120x60	Beyaz

KABLO BAĞLARI



ÖLÇÜ	RENK
2,5x100mm	Beyaz
2,5x150mm	Beyaz
2,5x200mm	Beyaz
3,6x150mm	Beyaz
3,6x200mm	Beyaz
3,6x250mm	Beyaz
3,6x300mm	Beyaz
3,6x370mm	Beyaz
4,8x200mm	Beyaz
4,8x250mm	Beyaz
4,8x300mm	Beyaz

SOKETLER



Dişi Büyük Soket



Dişi Küçük Soket



Dişi Yandan Geçmeli Soket



Delikli Büyük Soket



Delikli Küçük Soket



Erkek Soket



Soket Kılıfı

MAKARONLAR

SİLİKON MAKARONLAR



Silikon Makaron 2 mm



Silikon Makaron 3 mm



Silikon Makaron 4 mm



Silikon Makaron 5 mm

MAKARONLAR

BÜZÜŞEN MAKARONLAR



Büzüşen Makaron 3,5 mm



Büzüşen Makaron 5 mm



Büzüşen Makaron 7 mm



Büzüşen Makaron 9 mm



Büzüşen Makaron 13 mm



Büzüşen Makaron 20 mm





07



KLİMA

ALÜMİNYUM MONTAJ KİTLERİ	174
TEKLİ İZOLASYONLU BORULAR	174
ÇİFTLİ İZOLASYONLU BORULAR	175
İZOLASYONLAR	175
4 YOLLU VANALAR	176
FAN MOTORLARI	176
TEMİZLİK EKİPMANLARI	177
MONTAJ EKİPMANLARI	178
KART VE KUMANDA TAKIMLARI	180
KUMANDALAR	181
SENSÖRLER	183
TAHLİYE POMPALARI	183
KONDANSATÖRLER	184
SPLİT VANALAR	185

ALÜMİNYUM MONTAJ KİTLERİ

	AÇIKLAMA	UZUNLUK
	1/4-3/8 AL MONTAJ SETİ	3 METRE
	1/4-3/8 AL MONTAJ SETİ	5 METRE
	1/4-3/8 AL MONTAJ SETİ	7 METRE
	1/4-3/8 AL MONTAJ SETİ	10 METRE
	1/4-1/2 AL MONTAJ SETİ	3 METRE
	1/4-1/2 AL MONTAJ SETİ	5 METRE
	1/4-1/2 AL MONTAJ SETİ	7 METRE
	1/4-1/2 AL MONTAJ SETİ	10 METRE
	3/8-5/8 AL MONTAJ SETİ	3 METRE
	3/8-5/8 AL MONTAJ SETİ	5 METRE
	3/8-5/8 AL MONTAJ SETİ	7 METRE
	3/8-5/8 AL MONTAJ SETİ	10 METRE
	1/4-5/8 AL MONTAJ SETİ	3 METRE
	1/4-5/8 AL MONTAJ SETİ	5 METRE
	1/4-5/8 AL MONTAJ SETİ	7 METRE
	1/4-5/8 AL MONTAJ SETİ	10 METRE
	1/2-3/4 AL MONTAJ SETİ	3 METRE
	1/2-3/4 AL MONTAJ SETİ	5 METRE
	1/2-3/4 AL MONTAJ SETİ	7 METRE
	1/2-3/4 AL MONTAJ SETİ	10 METRE
	3/8-3/4 AL MONTAJ SETİ	3 METRE
	3/8-3/4 AL MONTAJ SETİ	5 METRE
	3/8-3/4 AL MONTAJ SETİ	7 METRE
	3/8-3/4 AL MONTAJ SETİ	10 METRE

TEKLİ İZOLASYONLU BORULAR

	ÜRÜN AÇIKLAMASI
	BEYAZ EUROCLASS İZOLASYONLU BAKIR BORU
	9 mm OTTOCOOL 1/4" x 0,7 SPLIT
	9 mm OTTOCOOL 3/8" x 0,7 SPLIT
	9 mm OTTOCOOL 1/2" x 0,7 SPLIT
	9 mm OTTOCOOL 5/8" x 0,8 SPLIT
	BEYAZ EUROCLASS İZOLASYONLU BAKIR BORU
	9 mm BEYAZ İZOLASYONLU EUROCLASS 1/4" x 0,8 mm
	9 mm BEYAZ İZOLASYONLU EUROCLASS 3/8" x 0,8 mm
	9 mm BEYAZ İZOLASYONLU EUROCLASS 1/2" x 0,8 mm
	9 mm BEYAZ İZOLASYONLU EUROCLASS 5/8" x 1,0 mm
	9 mm BEYAZ İZOLASYONLU EUROCLASS 3/4" x 1,0 mm
	13 mm BEYAZ İZOLASYONLU EUROCLASS 1/4" x 0,8 mm
	13 mm BEYAZ İZOLASYONLU EUROCLASS 3/8" x 0,8 mm
	13 mm BEYAZ İZOLASYONLU EUROCLASS 1/2" x 0,8 mm
	13 mm BEYAZ İZOLASYONLU EUROCLASS 5/8" x 1,0 mm
	13 mm BEYAZ İZOLASYONLU EUROCLASS 3/4" x 1,0 mm

ÇİFTLİ İZOLASYONLU BORULAR



ÜRÜN AÇIKLAMASI

9 mm BEYAZ ÇİFTLİ EUROCLASS İZOLASYONLU BAKIR BORU

9 mm ÇİFTLİ 1/4" x 0,8 + 3/8" x 0,8 BEYAZ EUROCLASS
9 mm ÇİFTLİ 1/4" x 0,8 + 1/2" x 0,8 BEYAZ EUROCLASS
9 mm ÇİFTLİ 1/4" x 0,8 + 1/2" x 0,9 BEYAZ EUROCLASS
9 mm ÇİFTLİ 1/4" x 0,8 + 5/8" x 1,0 BEYAZ EUROCLASS
9 mm ÇİFTLİ 3/8" x 0,8 + 5/8" x 1,0 BEYAZ EUROCLASS
9 mm ÇİFTLİ 3/8" x 0,8 + 3/4" x 1,0 BEYAZ EUROCLASS
9 mm ÇİFTLİ 1/2" x 0,8 + 3/4" x 1,0 BEYAZ EUROCLASS
9 mm ÇİFTLİ 1/4" x 0,7 + 3/8" x 0,7 BEYAZ EUROCLASS
9 mm ÇİFTLİ 1/4" x 0,7 + 1/2" x 0,7 BEYAZ EUROCLASS
9 mm ÇİFTLİ 3/8" x 0,7 + 5/8" x 0,8 BEYAZ EUROCLASS

13 mm BEYAZ ÇİFTLİ EUROCLASS İZOLASYONLU BAKIR BORU

13mm ÇİFTLİ 1/4" x 0,8 + 3/8" x 0,8 BEYAZ EUROCLASS
13mm ÇİFTLİ 1/4" x 0,8 + 1/2" x 0,8 BEYAZ EUROCLASS
13mm ÇİFTLİ 1/4" x 0,8 + 1/2" x 0,9 BEYAZ EUROCLASS
13mm ÇİFTLİ 1/4" x 0,8 + 5/8" x 1,0 BEYAZ EUROCLASS
13mm ÇİFTLİ 3/8" x 0,8 + 5/8" x 1,0 BEYAZ EUROCLASS

SİYAH EUROCLASS İZOLASYONLU BAKIR BORU

13 mm SİYAH İZOLASYONLU EUROCLASS 1/4" x 0,8
13 mm SİYAH İZOLASYONLU EUROCLASS 3/8" x 0,8
13 mm SİYAH İZOLASYONLU EUROCLASS 1/2" x 0,8
13 mm SİYAH İZOLASYONLU EUROCLASS 1/2" x 0,9
13 mm SİYAH İZOLASYONLU EUROCLASS 5/8" x 1,0
13 mm SİYAH İZOLASYONLU EUROCLASS 3/4" x 1,0

İZOLASYONLAR



	ÜRÜN		
06*06mm İzolasyon	09*06mm İzolasyon	13*06mm İzolasyon	19*18mm İzolasyon
06*08mm İzolasyon	09*10mm İzolasyon	13*10mm İzolasyon	19*22mm İzolasyon
06*10mm İzolasyon	09*12mm İzolasyon	13*12mm İzolasyon	19*28mm İzolasyon
06*12mm İzolasyon	09*18mm İzolasyon	13*15mm İzolasyon	19*35mm İzolasyon
06*15mm İzolasyon	09*22mm İzolasyon	13*18mm İzolasyon	19*42mm İzolasyon
06*18mm İzolasyon	09*28mm İzolasyon	13*22mm İzolasyon	
06*22mm İzolasyon	09*35mm İzolasyon	13*28mm İzolasyon	
06*28mm İzolasyon	09*42mm İzolasyon	13*35mm İzolasyon	
06*35mm İzolasyon	09*54mm İzolasyon	13*42mm İzolasyon	
06*42mm İzolasyon	09*15mm İzolasyon	13*60mm İzolasyon	

4 YOLLU VANALAR



ÜRÜN ADI	AÇIKLAMA	UZUNLUK
DSF-4	13500 BTU	5/16" - 3/8"
DSF-9	30500 BTU	3/8" - 1/2"
DSF-9B	30500 BTU	3/8" - 5/8"
DSF-11B	37500 BTU	1/2" - 5/8"
DSF-20	68000 BTU	1/2" - 3/4"
DSF-34H	116000 BTU	3/4" - 7/8"
DSF-34D	116000 BTU	7/8" - 11/8"
DSF-50	170000 BTU	7/8" - 11/8"
BOBIN 220V		
BOBIN 24V		

FAN MOTORLARI

DIŞ ÜNİTE FAN MOTORLARI



32001256

Vestel Fan Motoru 9000-12000 Btu



5400087815

Arçelik Fan Motoru 12000-14000-15000 Btu



5400087825

Arçelik Fan Motoru 7000-9000 Btu



5400609304

Arçelik Fan Motoru 18000-19000-24000 Btu

FAN MOTORLARI

İÇ ÜNİTE FAN MOTORLARI



32018515

Vestel İç Ünite Fan Motoru 9000-12000 Btu



5400042904

Arçelik İç Ünite Fan Motoru 18000-19000 Btu

FAN MOTORLARI

İÇ ÜNİTE FAN MOTOLARI



5400042908

Arçelik iç Ünite Fan Motoru
24000 Btu

5400231698

Arçelik iç Ünite Fan Motoru
12000-14000 Btu

5400254625

Arçelik iç Ünite Fan Motoru
24000 Btu

5400361002

Arçelik iç Ünite Fan Motoru
11000-12000-12500 Btu

5400361003

Arçelik iç Ünite Fan Motoru
7000-9000 Btu

TEMİZLİK EKİPMANLARI



9197071835

Klima Kokusu 58 g



9191470015

Klima Temizleme Sıvısı
1000 ml

Klima Temizleme Sıvısı 1Lt



Klima Temizleme Sıvısı 5 Lt

Allgoo Klima Dezenfektan
Parfüm 400 mlKlima İlaç Pompası Uzun
Uçlu 2 Lt

TEMİZLİK EKİPMANLARI



Klima İlaç Pompası 2 Lt



Klima İlaç Pompası 2 Lt İtalyan



Klima İlaç Pompası Şarjlı ve Elektrikli Püskürtücü 16 Lt



Klima Temizlik Branda Çadır



Klima İlaç Pompası 6 Lt

MONTAJ EKİPMANLARI



Klima Konsolu (Ayak) Vidalı 40 Cm Tk



Klima Konsolu (Ayak) Vidalı 50 Cm Tk



Klima Konsolu (Ayak) Kaynaklı 60 Cm Tk



Siyah İzole Bant



Beyaz İzole Bant



Dar Dekoratif Bant

MONTAJ EKİPMANLARI



Geniş Dekoratif Bant

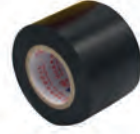

Siyah Geniş İzole Bant



Beyaz Geniş İzole Bant



Alüminyum Bant 48x25

Alüminyum Bant Takviye İpli
48x25

Drenaj Hortumu 5bölü8



Drenaj Hortumu 3bölü4



Drenaj Çıkış Dirseği



Drenaj Hortum Y si



Drenaj Hortum Kroşesi



Drenaj Hortum Nipeli



Drenaj Hortum T si

Klima Mantolama Dubeli 4
LüKlima Dubeli 12 Lik Takım
Gaz Beton 10 lu

MONTAJ EKİPMANLARI



Klima Dubeli 12 Lik Gaz Beton 10 lu (İkinci Kalite)



Dubel



Tij

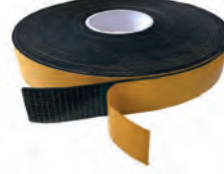

Yapışkanlı Bant Kauçuk (Amtape)



Takoz Lastiği 35x30x2



Takoz Lastiği 45x30x2



Takoz Lastiği 60x50x1



Takoz Lastiği 50x40x1

KART VE KUMANDA TAKIMLARI



Inverter Klima Kumanda Kartlı QD-80C DC 24V



Inverter Klima Kumanda Kartlı QD-80C AC 220V



Klima Kumanda Kartlı QD-U03C+



Klima Kumanda Kartlı QD-U11A

KART VE KUMANDA TAKIMLARI



Klima Kumanda Kartlı QD-U10A



Klima Kumanda Kartlı QD-U12A



Klima Kumanda Kartlı QD-U30A



Klima Kumanda Kartlı QD-U05PG+

KUMANDALAR



5401219102 Arçelik Klima Kumanda



5400616401 Arçelik Klima Kumanda



Klima Kumanda Arçelik 5400185204



Klima Kumanda Midea



Klima Kumanda Vestel Regal (Beyaz) KL-0140



Klima Kumanda KT-4000



Klima Kumanda Electra RC3



Klima Kumanda Electra RC5

KUMANDALAR



Klima Kumanda KT-E05



Klima Kumanda Demirdöküm KL-0131



Klima Kumanda KT-9018



Klima Kumanda Vestel Regal (Gri) KL-0139



Klima Kumanda Seikon KL-0102



Klima Kumanda KT-518



Klima Kumanda KT-N828



Klima Kumanda KT-1000



Klima Kumanda Demirdöküm KL-0105



Klima Kumanda Vestel KL-0101



Klima Kumanda Fujitsu



Klima Kumanda Mitsubishi



Klima Kumanda Gree&Airfel



Klima Kumanda Alarko&-Carrier

KUMANDALAR



Klima Kumanda Panasonic



Klima Kumanda Samsung

Klima Kumanda Universal
KT-B03Klima Kumanda Universal
KT-E08

SENSÖRLER

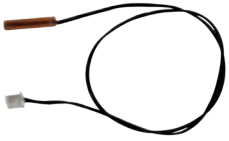

Termistör Metal Uçlu



Termistör Plastik Uçlu



Termistör Sıcak Soğuk İkili

TAHLİYE POMPALARI

Klima Tahliye Pompası PSB-
1218Klima Tahliye Pompası PSB-
1018

TAHLİYE POMPALARI



Kodu

Klima Tahliye Pompası DP-168

KONDANSATÖRLER



ÜRÜN ADI	AÇIKLAMA
30+1.5 MF KONDANSATÖR Klima	-25+80° C 370/400V, 50/60Hz
30+6 MF KONDANSATÖR Klima	-25+80° C 370/400V, 50/60Hz
35+1.5 MF KONDANSATÖR Klima	-25+80° C 370/400V, 50/60Hz
35+2.5 MF KONDANSATÖR Klima	-25+80° C 370/400V, 50/60Hz
35+6 MF KONDANSATÖR Klima	-25+80° C 370/400V, 50/60Hz
40+1.5 MF KONDANSATÖR Klima	-25+80° C 370/400V, 50/60Hz
45+1.5 MF KONDANSATÖR Klima	-25+80° C 370/400V, 50/60Hz
45+5 MF KONDANSATÖR Klima	-25+80° C 370/400V, 50/60Hz
45+10 MF KONDANSATÖR Klima	-25+80° C 370/400V, 50/60Hz
50+1,5 MF KONDANSATÖR Klima	-25+80° C 370/400V, 50/60Hz
50+5 MF KONDANSATÖR Klima	-25+80° C 370/400V, 50/60Hz
50+6 MF KONDANSATÖR Klima	-25+80° C 370/400V, 50/60Hz
55+5 MF KONDANSATÖR Klima	-25+80° C 370/400V, 50/60Hz
55+6 MF KONDANSATÖR Klima	-25+80° C 370/400V, 50/60Hz
60+6 MF KONDANSATÖR Klima	-25+80° C 370/400V, 50/60Hz



ÜRÜN ADI	AÇIKLAMA
0.9 MF KONDANSATÖR KARE TİP	-25+80° C 370/400V, 50/60Hz
1 MF KONDANSATÖR KARE TİP	-25+80° C 370/400V, 50/60Hz
1.5 MF KONDANSATÖR KARE TİP	-25+80° C 370/400V, 50/60Hz
2 MF KONDANSATÖR KARE TİP	-25+80° C 370/400V, 50/60Hz
2,5 MF KONDANSATÖR KARE TİP	-25+80° C 370/400V, 50/60Hz
3 MF KONDANSATÖR KARE TİP	-25+80° C 370/400V, 50/60Hz
4 MF KONDANSATÖR KARE TİP	-25+80° C 370/400V, 50/60Hz
5 MF KONDANSATÖR KARE TİP	-25+80° C 370/400V, 50/60Hz

SPLİT VANALAR



ÜRÜN ADI

SPLİT KLİMA VANA 1/4

SPLİT KLİMA VANA 3/8

SPLİT KLİMA VANA 1/2

SPLİT KLİMA VANA 5/8

SPLİT KLİMA VANA 3/4

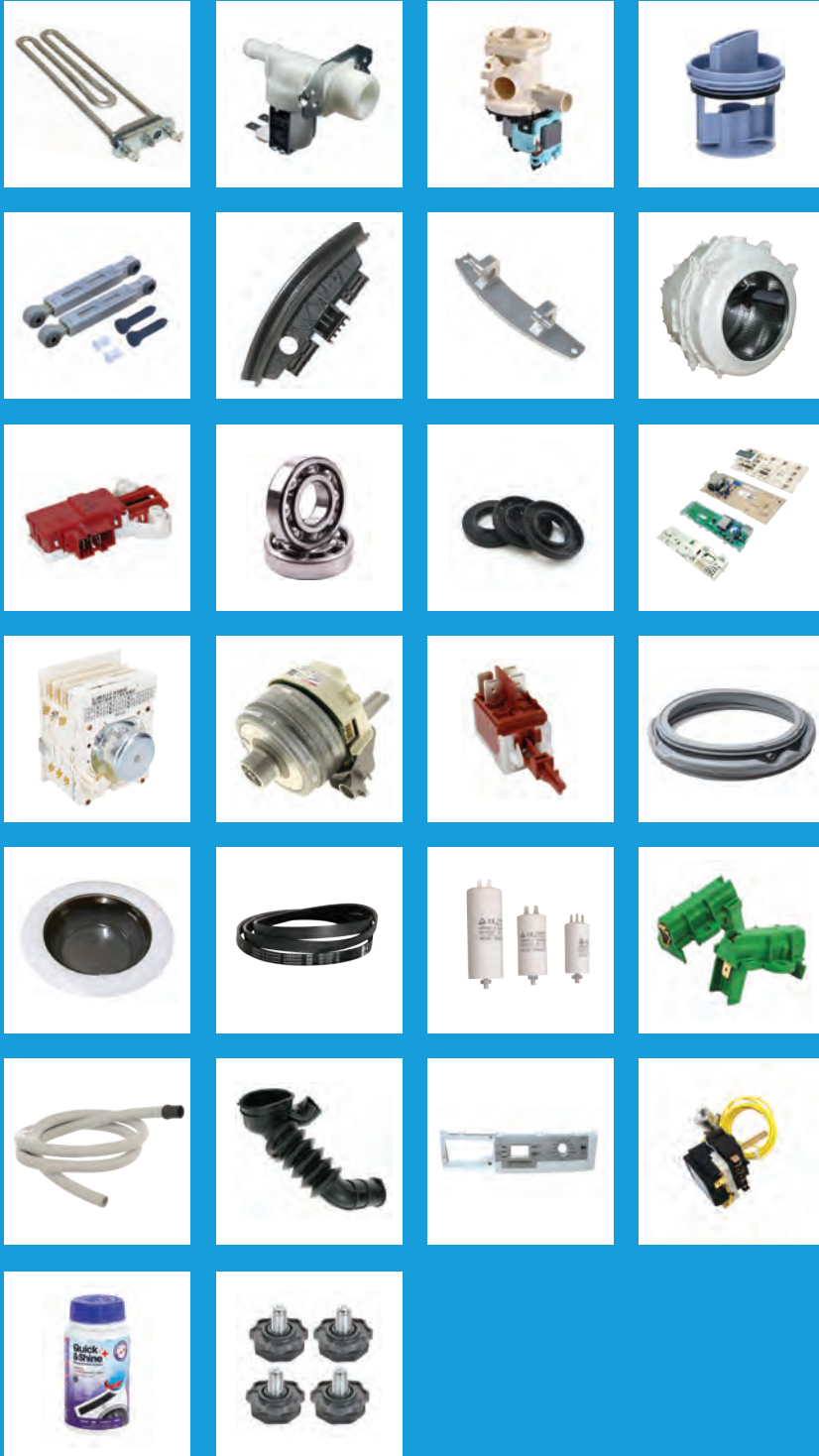

08



OTOMATİK ÇAMAŞIR MAK.

ISITICILAR	188
VENTİLLER	188
POMPALAR	190
POMPA FİLTRE KAPAKLARI	192
AMORTİSÖRLER	193
TUTAMAKLAR	193
MENTEŞELER	197
KAZAN GRUPLARI	197
KAPI KİLİTLERİ	199
RULMANLAR	201
YAĞ KEÇELERİ	202
ELEKTRONİK KARTLAR	203
PROGRAM CİHAZLARI	206
YIKAMA MOTORLARI	207
ANAHTARLAR	208
KÖRÜK LASTİKLERİ	209
KAPAK VE ÇERÇEVELER	211
KAYIŞLAR	212
KONDANSATÖRLER	213
KÖMÜRLER	213
SU GİRİŞ VE TAHLİYE HORTUMLARI	214
DETERJAN VE KAZAN HORTUMLARI	215
PANO VE IŞIK TAŞIYICILAR	216
TERMOSTATLAR	217
KİREÇ ÖNLEYİCİ AKSESUARLAR	218
MUHTELİF PARÇALAR	219

ISITICILAR



Bosch Delikli Isıtıcı 2000 W



Profilo Aeg Vestel Isıtıcı



Arçelik 2600 Isıtıcı



Arçelik 3320 Termikli Isıtıcı



Bosch Max Ntcli Isıtıcı



Ariston Termikli Isıtıcı



Ariston Delikli Isıtıcı



Arçelik 2100 Isıtıcı



Endüstriyel Çamaşır Makinesi Isıtıcı 3000W



Ntc

VENTİLLER



Tekli Vidalı Ventil 180 Derece İnce



Tekli Geçmeli Ventil 180 Derece İnce

VENTİLLER



Tekli Vidalı Ventil 180 Derece
İnce 24 Volt



Tekli Vidalı Ventil 90 Derece
İnce



Tekli Vidalı Ventil 90 Derece
Kalın



Tekli Geçmeli Ventil 90
Derece İnce



Ariston Merloni Tekli Geçme-
li Ventil 066517-074585



İkili Vidalı Ventil 180 Derece
İnce



İkili Geçmeli Ventil 180
Derece İnce



İkili Geçmeli Ventil Derece
Arçelik İnce



İkili Vidalı Ventil 90 Derece
İnce



Bosch Max İkili Kartlı Ventil



Bosch Logixx İkili Kartlı
Ventil



Arçelik İkili Grup Soket ve
Okuyuculu Ventil



Ariston Merloni İkili Ventil
066518-074586



Ariston Merloni İkili Ventil
Grup Soketli 110133

VENTİLLER

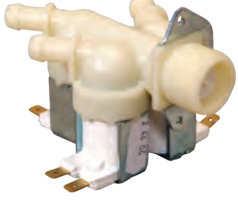

Üçlü Vidalı Ventil 180 Derece İnce



Üçlü Vidalı Ventil 90 Derece İnce



Üçlü Vidalı Ventil 90 Derece Kalın

POMPALAR



Vidalı Plaset Pompa



Geçmeli Tip Plaset Pompa



Geçmeli Tip Kare Pompa



Sarex Aeg E56 Lavamat Plaset Pompa



Arçelik 3650 Plaset Pompa



Arçelik 2100 Plaset Pompa



Arçelik 2600 Plaset Pompa



Bosch Maxx Plaset Pompa

POMPALAR



Bosch 1610 İnce Plaset Pompa



Bosch Logixx Plaset Pompa



Profilo Çabuk Servis Plaset Pompa



Ariston Vestel Plaset Pompa



Vestel Piton 8 Kg Plaset Pompa



Samsung Plaset Pompa



2878101700
Arçelik SJ Pompa Grubu

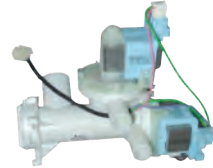

2878103000
Arçelik Sj Pompa Grubu



Plaset Pompa İtalyan Vidali



Plaset Pompa İtalyan Vidali



Plaset Pompa İtalyan Geçmeli



Plaset Pompa İtalyan Kare



Plaset Pompa İtalyan 4 Tırnaklı



Bosch Maxx İtalyan Pompa

POMPALAR



145428 Bosch Maxx Orijinal
Plaset Pompa Motoru



Plaset Pompa İtalyan Bosch
Logixx



Plaset Pompa İtalyan Vestel
- Ariston



Ayran Makine Pompası
Filtreli 55 Watt



Sargılı Pompa İtalyan Arçelik
2100

POMPA FİLTRE KAPAKLARI



Bosch Yeni Tip Gri Pompa
Kapağı



Bosch Yeni Tip Siyah Pompa
Kapağı



Bosch Beyaz Pompa Kapağı



Vestel Ariston Pompa
Kapağı



Arçelik Pompa Kapağı

AMORTİSÖRLER



Arçelik Yatay Uzun Amortisör



Bosch Max Amortisör Takımı 448032 (2 Li)



2803250200

Arçelik Amortisör



Arçelik Yatay Plastik Amortisör



Vestel Yatay Kısa Amortisör



Arçelik Yatay Siyah Amortisör



Kodu

Arçelik Dikey Amortisör



Kodu

Bosch Max Amortisör



Kodu

Bosch Max Amortisör Tamir Takımı



Kodu

Amortisör Pimi

TUTAMAKLAR



Lg Tutamak Gri 3650EN3005



Lg - Arçelik Tutamak Gri 3650ER2003A

TUTAMAKLAR



2826990100

Arçelik Tutamak



2827010100

Arçelik Tutamak



Arçelik Tutamak Model 3
(2839780300)



9190872015

Arçelik Kurutmalı Tutamak



2832510100

Arçelik Tutamak



2832510200

Arçelik Tutamak



2821580100

Arçelik Tutamak



2821580200

Arçelik Tutamak



2828780100

Arçelik Tutamak



2806270200

Arçelik Tutamak



2835780600

Arçelik Tutamak



2816530100

Arçelik Tutamak



2804940100

Arçelik Tutamak



2805990100

Arçelik Tutamak

TUTAMAKLAR



2813170100

Arçelik Tutamak



Arçelik 2600 Tutamak



Arçelik 2100 Tutamak



Bosch Yeni Tip Beyaz Tutamak



Bosch Yeni Tip Gri Tutamak



Bosch Logixx Beyaz Tutamak



Bosch Logixx Gri Tutamak



Bosch Max Hilal Tutamak



Bosch Max Kısa Tutamak



Profilo Pasific Tutamak



Profilo Aeg Tutamak

Vestel Gri Tutamak
42106256Vestel Beyaz Tutamak
42070217Vestel Metalik Gri Tutamak
42082671

TUTAMAKLAR



Vestel Tutamak 42023890



Vestel Yeni Tip 5 Kg Tutamak



Vestel Aura Gri Tutamak



Vestel Aura Beyaz Tutamak



Vestel Hidra-İntraton Beyaz Tutamak



Vestel Hidra-İntraton Gri Tutamak



Vestel Junda Beyaz Tutamak



Vestel Junda Gri Tutamak



42029516 Vestel Beyaz Tutamak



Vestel Vega Tutamak



Vestel Wms Tutamak



Simtel Teba Tutamak



Simtel Teba Tutamak

MENTEŞELER



Arçelik 2805710100 Mentese



Arçelik 2807210100 Mentese



Arçelik 2905710100 Mentese



Arçelik 2100 Mentese



Arçelik 2600 Mentese



Vestel Mentese



Bosch Maxx Mentese



Bosch Logixx Mentese

KAZAN GRUPLARI



2879001100

Arçelik Kazan Grubu



2879000701

Arçelik Kazan Grubu



2415600101

Arçelik Kazan Grubu



2415701100

Arçelik Kazan Grubu

KAZAN GRUPLARI



2415602501

Arçelik Kazan Grubu



2415600101

Arçelik Kazan Grubu



2415601701

Arçelik Kazan Grubu



2415600101

Arçelik Kazan Grubu



2880601501

Arçelik Kazan Grubu



2879203601

Arçelik Kazan Grubu



2415600101

Arçelik Kazan Grubu



2879203201

Arçelik Kazan Grubu



2825500300

Arçelik Kazan Grubu

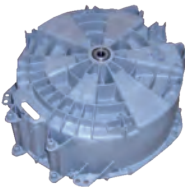

2825500200

Arçelik Kazan Grubu



2880600101

Arçelik Kazan Grubu



2825500100

Arçelik Kazan Grubu



2825000100

Arçelik Kazan Grubu

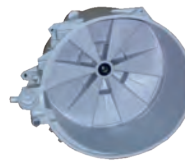

2815500200

Arçelik Kazan Grubu

KAZAN GRUPLARI



2804200400

Arçelik Kazan Grubu



2838500200

Arçelik Kazan Grubu

KAPI KİLİTLERİ



Arçelik Mini Kapı Kilidi
2805310100



2847740500

Arçelik Kapı Kilidi



Arçelik Yoç 3 Soket Kapı
Kilidi



Arçelik Yoç 4 Soket Kapı
Kilidi



Arçelik 2600 Kapı Kilidi



Arçelik 2100 İtalyan 3 Soket
Kapı Kilidi



638259

Bosch Logixx Kapı Kilidi



Bosch Kapı Kilidi 613070



Bosch Kapı Kilidi 619468



Bosch Kapı Kilidi
171256-182154

KAPI KİLİTLERİ



Bosch Max Kapı Kilidi



Indesit Kapı Kilidi 085194



Indesit Kapı Kilidi 299278

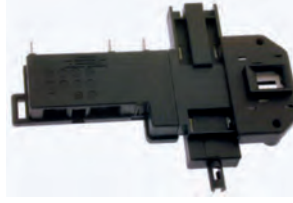

Indesit Kapı Kilidi 51438



Indesit Kapı Kilidi 254755



Indesit Kapı Kilidi 254755-2



Indesit Kapı Kilidi
160030046



Indesit Kapı Kilidi 309745

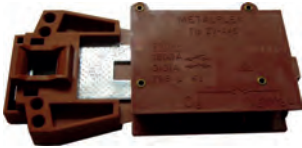

Indesit Kapı Kilidi



Vestel Kapı Kilidi V32018336



Vestel Kapı Kilidi 30023290-
32019331



Vestel Kapı Kilidi 32005174



Vestel Kapı Kilidi 32024465



Samsung Kapı Kilidi DC64-
00653A

KAPI KİLİTLERİ



Samsung Kapı Kilidi DC64-01538C



Samsung DC64-00653 B Kapı Kilidi



Samsung DC64-00653 C Kapı Kilidi



Samsung DC64-01538 A Kapı Kilidi



Samsung DC64-01538 C Kapı Kilidi



Samsung DC 64-00120 E Kapı Kilidi

RULMANLAR



MARKA	MODEL
NBJ	608 ZZ
NBJ	626 ZZ
ORS	6201 ZZ
ORS	6202 ZZ
ORS	6203 ZZ
ORS	6204 ZZ
ORS	6205 ZZ
ORS	6206 ZZ
ORS	6207 ZZ
ORS	6305 ZZ
ORS	6306 ZZ
ORS	6307 ZZ

YAĞ KEÇELERİ



MARKA
2827130100 Arçelik 40x62x10 Keçe
2823410100 Arçelik 25x50x10 Keçe
Skt 30x52x10/10,5 Keçe
Skt 35x65x10 Keçe
35x65x10/12 Keçe
Skt 28x62x10/12
Skt 30x55x10
30x62x10 Keçe
30x60x10 Keçe
40x72x10 Keçe
40x80x10 Keçe
37x62x8 Keçe
40x66x10/11,5 Keçe
28x62x10/12 Keçe
25x47x7 Keçe
30x62/73x10,5/15,5 Keçe
35x65/76x13/10 Keçe
45x80x10 Keçe
47x72x10 Keçe
30x55/80x10/13 Keçe
25x50,5x10 Keçe
Skt 22x45x10 Keçe
Skt 40x62/9.5x11 Arçelik Keçe
Skt 25x50x9 Arçelik Keçe
37x76/9.5x12 Arçelik Keçe
25x47/64x7/10 Indesit Dar Keçe
39667 35x52/65/7x10 Indesit Geniş Keçe
25x50x10 Arçelik Pls. Kazan Keçe
40x62x10 Arçelik Pls. Kazan Keçe
22x40x10 Keçe
22x42x10 Keçe
37x62x10 Bosch Keçe
37,4x62x10/12 Bosch Keçe
42,4x72x10/12 Bosch Keçe
28x62x10 Bosch Keçe
45x72/86x8/12 Arçelik 2200 Keçe
30x52x10 Vestel Keçe
40x70/80x10,5/15 Bosch Melez Keçe
30x55x10 Vestel Keçe
Skt 45x72x10 Keçe
25x52x10 Vestel Keçe
25x47x10 Vestel Keçe
35x62x10 Arç-Vestel-Simtel Keçe
40x62/78x10/15 Arç. 2600 Keçe
21x40x7 Simtel Keçe

YAĞ KEÇELERİ

	20x40x7 Simtel Keçe
	35x52x10 Keçe
	30x60,55x10/12 Samsung Keçe
	35x65,55x10/12 Samsung Keçe
	35x75,55x10/12 Samsung Keçe
	30x53,5x10/14 Vestel Keçe
	37x66x9,5/12 Arç. 7 Kg Keçe
	35x72x10 Keçe
	35x65/76x10/12 Aeg 800 Sac Keçe
	40x72,5/87x8/13 Bosch Keçe
	35x52/65x7/10.5 Ariston Geniş Keçe
	35x74/80,5x11/15 Bosch Keçe
	45x78/86x10,5/15 Aeg Büyük Melez Keçe

ELEKTRONİK KARTLAR

	KODU	MODEL
	2822530041	Arçelik Elektronik Kart
2822270722	Arçelik Elektronik Kart	
2822950290	Arçelik Elektronik Kart	
2822530291	Arçelik D5060 B Elektronik Kart	
2824383100	Arçelik 9123H Elektronik Kart	
2822950295	Arçelik Elektronik Kart	
2817940022	Arçelik Elektronik Kart	
2822970053	Arçelik Elektronik Kart	
2823330080	Arçelik Elektronik Kart	
2822650180	Arçelik Elektronik Kart	
2827820190	Arçelik Elektronik Kart	
C00097400	Hotpoint-Ariston Çamaşır Makinesi LED Kartı	
20840254	Vestel Elektronik Kart	
2419806001	Arçelik Elektronik Motor Kontrol Kartı	
2826480021	Arçelik Elektronik Kart	
2822941020	Arçelik Elektronik Kart	
2822842031	Arçelik Elektronik Kart	
2822781046	Arçelik Elektronik Kart	
2807350300	Arçelik Elektronik Kart	
2807351800	Arçelik Elektronik Kart	
2817740070	Arçelik Elektronik Kart	
2817740280	Arçelik Elektronik Kart	
2811470082	Arçelik Elektronik Kart	
2817710132	Arçelik Elektronik Kart	
2811460042	Arçelik Elektronik Kart	

ELEKTRONİK KARTLAR

KODU	MODEL
2811470072	Arçelik Elektronik Kart
2827840715	Arçelik Elektronik Kart
2811470102	Arçelik Elektronik Kart
2822950305	Arçelik Elektronik Kart
2827681020	Arçelik Elektronik Kart
2817930220	Arçelik Elektronik Kart
2822640023	Arçelik Elektronik Kart
	Vestel Wmu Elektronik Kart
49373	Ariston Elektronik Kart
66454	Indesit Elektronik Kart
20893114	Vestel Elektronik Kart
20668717	Vestel Elektronik Kart
20678874	Vestel Elektronik Kart
20661221	Vestel Elektronik Kart
20661219	Vestel Elektronik Kart
20661216	Vestel Elektronik Kart
20663573	Vestel Elektronik Kart
20755242	Vestel Elektronik Kart
20668716	Vestel Elektronik Kart
20663572	Vestel Elektronik Kart
2822650041	Arçelik Elektronik Kart
2826480162	Arçelik Elektronik Kart
2824446480	Arçelik Elektronik Kart
2827820260	Arçelik Elektronik Kart
2822530411	Arçelik Elektronik Kart
2824446150	Arçelik Elektronik Kart
	Bosch Maxx Elektronik Kart (Revizyonlu)
2822530051	Arçelik Elektronik Kart
2817940023	Arçelik Elektronik Kart
2800730300	Arçelik Elektronik Kart
2807350100	Arçelik Elektronik Kart
2603820100	Arçelik Elektronik Kart
2817740091	Arçelik Elektronik Kart
2817740080	Arçelik Elektronik Kart
2817710161	Arçelik Elektronik Kart
2817740270	Arçelik Elektronik Kart
2817740110	Arçelik Elektronik Kart
2819490031	Arçelik Elektronik Kart
2817710081	Arçelik Elektronik Kart
2811470112	Arçelik Elektronik Kart
2811470062	Arçelik Elektronik Kart
2817710181	Arçelik Elektronik Kart
2817930063	Arçelik Elektronik Kart
2811460032	Arçelik Elektronik Kart
2817740201	Arçelik Elektronik Kart
2817740141	Arçelik Elektronik Kart
2817710121	Arçelik Elektronik Kart

ELEKTRONİK KARTLAR



KODU	MODEL
2817930112	Arçelik Elektronik Kart
2811460012	Arçelik Elektronik Kart
2823010083	Arçelik Elektronik Kart
2824220060	Arçelik Elektronik Kart
2811460052	Arçelik Elektronik Kart
2822842101	Arçelik Elektronik Kart
2824260160	Arçelik Elektronik Kart
2811470122	Arçelik Elektronik Kart
2822950083	Arçelik Elektronik Kart
2822950023	Arçelik Elektronik Kart
2822650190	Arçelik Elektronik Kart
2822950306	Arçelik Elektronik Kart
2822921025	Arçelik Elektronik Kart
2822530036	Arçelik Elektronik Kart
2822270063	Arçelik Elektronik Kart
2822950280	Arçelik Elektronik Kart
2822781036	Arçelik Elektronik Kart
2823010063	Arçelik Elektronik Kart
2817740191	Arçelik Elektronik Kart
2822950285	Arçelik Elektronik Kart
2822911021	Arçelik Elektronik Kart
2811460022	Arçelik Elektronik Kart
2823010086	Arçelik Elektronik Kart
2824260200	Arçelik Elektronik Kart
2822270065	Arçelik Elektronik Kart
2823010073	Arçelik Elektronik Kart
2827820042	Arçelik Elektronik Kart
2824030040	Arçelik Elektronik Kart
2817740210	Arçelik Elektronik Kart
2822530011	Arçelik Elektronik Kart
2822950033	Arçelik Elektronik Kart
2817740151	Arçelik Elektronik Kart
2823010066	Arçelik Elektronik Kart
2817710012	Arçelik Elektronik Kart
2824220040	Arçelik Elektronik Kart
2822950013	Arçelik Elektronik Kart
2817710171	Arçelik Elektronik Kart
2824230080	Arçelik Elektronik Kart
2819490040	Arçelik Elektronik Kart
2827830032	Arçelik Elektronik Kart
2817850040	Arçelik Elektronik Kart
2822970043	Arçelik Elektronik Kart
20893119	Vestel Elektronik Kart
20688716	Vestel Elektronik Kart
20626886	Vestel Elektronik Kart
20626344	Vestel Elektronik Kart
52004531	Vestel Elektronik Kart

PROGRAM CİHAZLARI



2827190100

Arçelik Potansiyometre



2707350100

Arçelik Potansiyometre



2707360100

Arçelik Potansiyometre



2707360200

Arçelik Potansiyometre



2818280100

Arçelik Program Cihazı



2824700100

Arçelik Program Cihazı



2704760300

Arçelik Program Cihazı



2817970100

Arçelik Program Cihazı



2817970200

Arçelik Program Cihazı -
Kopya



2817970300

Arçelik Program Cihazı



2817970500

Arçelik Program Cihazı

YIKAMA MOTORLARI



Altus 4 Bacak Yıkama Motoru 7 Soket (Revizyonlu)



Arçelik Truva (Tff) Kısa Mil Yıkama Motoru 8 Soket



Arçelik Truva (Tff) Uzun Mil Yıkama Motoru 8 Soket



Arçelik Truva (Tff) Kısa Mil Yıkama Motoru 10 Soket



Arçelik Inverter Yıkama Motoru (Revizyonlu)



Arçelik 3320 Yıkama Motoru (Revizyonlu)



Arçelik 2600 Yıkama Motoru (Revizyonlu)



Arçelik 2200 Yıkama Motoru (Revizyonlu)



Bosch Mini Yıkama Motoru (Revizyonlu)



Bosch Maxx Yıkama Motoru (Revizyonlu)



Aeg Lavamat Yıkama Motoru 8 Soket (Revizyonlu)

ANAHTARLAR



Arçelik Yeni Tip Işıklı Anahtar



Arçelik Anahtar



Arçelik 3 Soket Fonksiyon Anahtarı



Arçelik 6 Soket Fonksiyon Anahtarı



Arçelik 5 Soket Fonksiyon Anahtarı



Bosch Indesit Anahtar



Vestel Bosch Anahtar



Profilo Aeg 3 Lü Grup Anahtar



Vestel Elektronik Anahtar



Vestel White Anahtar



Vestel Anahtar



Electrolux Anahtar

KÖRÜK LASTİKLERİ



2827084300 Arçelik Körük Lastik



2466300303 Altus Körük



Arçelik Körük Lastik
2827081200



Arçelik Körük Lastik
2827081100



Arçelik Körük Lastik
2827081000



Arçelik Körük Lastik
2827080900



Arçelik 4320-4340 M Körük
Lastik 2804860300



2466300300 Arçelik Körük
Lastik



Arçelik Körük Lastik
2905570100



Arçelik Körük Lastik
2904520100



Arçelik Yıkamalı Kurutmalı
Körük Lastik - 2845240100



Arçelik 3650 Dar Körük
Lastik



Arçelik 3320-3340 Körük
Lastik 2807710200



Arçelik Su Jetli 3650 SJ
Körük Lastik 2821430100

KÖRÜK LASTİKLERİ



Arçelik 2600 Kırük Lastik
2600180000



Arçelik 2100 Kırük Lastik
2001550000



Vestel Slim Kırük Lastik
42004246



Vestel Piton Slim Kırük
Lastik 42026977



Vestel 8 KG Kırük Lastik
42024953



Vestel 8 Kg Su Jetli Kırük
Lastik 42525995



Vestel Kurutmali Kırük
Lastik 42060771



Vestel Alva Kırük Lastik
42002568



Bosch Logixx 8 KG Kırük
Lastik 680768-680769



Bosch Logixx 8 Kg Delikli
Kırük Lastik - 680405-
478300



Bosch Maxx Kırük Lastik
Delikli 361127



Bosch Maxx Kırük Lastik
354135



Bosch Fx Kırük Lastik
667220





AEG Lavamat Kırük Lastik

KÖRÜK LASTİKLERİ

	Elektrolux K�r�k Lastik 3790201408		Samsung K�r�k Lastik DC61-20219E
	Samsung K�r�k Lastik DC64-03198A		Samsung Kurutmal� K�r�k Lastik DC64-01827A
	Samsung K�r�k Lastik DC64-03092A		Samsung K�r�k Lastik DC64-01664A
	Samsung K�r�k Lastik DC64-01602A		Samsung K�r�k Lastik DC64-00563A
	Samsung K�r�k Lastik DC64-00563B		

KAPAK VE  ER EVELER

	2835100900 Ar�elik �n Kapak Grubu		2860201800 Ar�elik �n Kapak Grubu
---	--------------------------------------	--	--------------------------------------

KAPAK VE ÇERÇEVELER



2860201700

Arçelik Ön Kapak Grubu



Arçelik 2600 Çerçeve Takım



Arçelik 2100 Çerçeve Takım



Profilo Aeg Çerçeve Takım

KAYIŞLAR

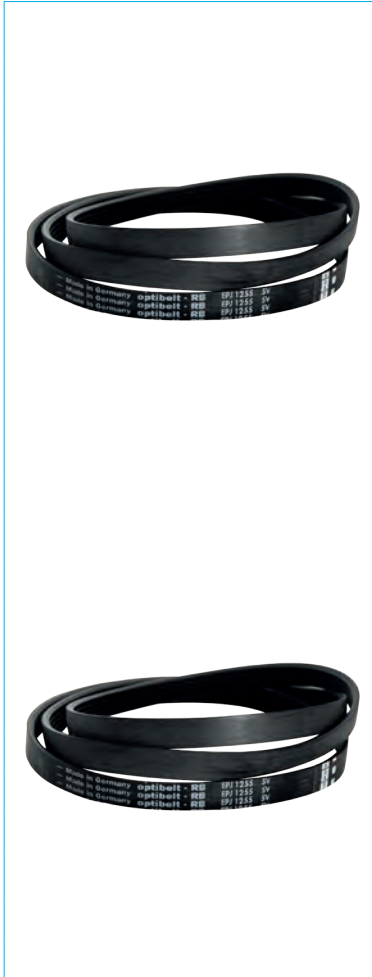

KODU	MODEL
2962470100	Arçelik Kurutmalı Kayış 1956 7PH
2810970100	Arçelik 1276 Kayış
	Arçelik 1244 Kayış
	Arçelik 1309 Kayış
2005170400	Arçelik 1277 Kayış
2810260100	Arçelik 1270 İnce Kayış
	Arçelik 1243 Kayış
	Arçelik 1301 Kayış
2953240200	Arçelik 1967 Kayış
	Vestel 1185 İnce Kayış
	Vestel 1227- 1228 Kayış
	1321 Kayış
	Bosch 1252 Kayış
	Bosch 1155 İnce Kayış
	Bosch 1163 Kayış
	Bosch 1255 Kayış
	Bosch 1262 Kayış
	Bosch 1270 Kayış
	Ariston 1195 İnce Kayış
	Ariston 1221 İnce Kayış
	1287 Kayış
	1173 Kayış

KONDANSATÖRLER



Kondansatör 10 Mf



Kondansatör 16 Mf



Kondansatör 20 Mf



Kondansatör 25 Mf

KÖMÜRLER



371202410 Arçelik Kömür Grubu



Yataklı Grup Kömür Grubu Model 1 Kırmızı



Yataklı Grup Kömür Grubu Model 2 Siyah



Yataklı Grup Kömür Grubu Model 3 Yeşil



Saçlı Kömür Grubu 2 li



Arçelik Bosch Yandan Çıkış Kömür Grubu 2 li



Arçelik Bosch Ortadan Çıkış Küçük Kömür Grubu 2 li



Vestel Ariston Ortadan Çıkış Büyük Kömür Grubu 2 li

KÖMÜRLER



Bosch Yaylı Kömür Grubu
2 li



Kollektör Ark Taşı

SU GİRİŞ VE TAHLİYE HORTUMLARI



Su Giriş Hortum Contası 50
li Paket



Su Giriş Hortumu 1,5 Mt



Su Giriş Hortumu 3 Mt



Tahliye Hortumu 1,5 Mt



Tahliye Hortumu 3 Mt



Tahliye Hortumu Dirsekli 3
Mt



Su Giriş Çatalı



Su Giriş Nipeli

DETERJAN VE KAZAN HORTUMLARI



2830560100

Arçelik Kazan Hortum



2701020000

Arçelik Kazan Su Giriş Hortumu



2806020100

Arçelik Kazan Su Giriş Hortumu



2600250000

Arçelik Kazan Su Giriş Hortumu



265958

Bosch Kazan Su Giriş Hortumu



Vestel Kazan Su Giriş Hortumu



2945900100

Arçelik Buhar Hortumu



2800890100

Arçelik Buhar Hortumu



2865200100

Arçelik Kazan Pompa Hortumu



2800870100

Kazan Pompa Hortumu



2704080100

Arçelik Kazan Pompa Hortumu



2801980100

Arçelik Kazan Pompa Hortumu



2600750000

Arçelik Kazan Pompa Kazan Hortumu



Bosch Logixx Kazan Su Pompa Hortumu (659871)

DETERJAN VE KAZAN HORTUMLARI



480442

Bosch Kazan Pompa Hortumu



2704090100

Arçelik Kazan Pompa Hortumu



2819090100

Arçelik Kazan Pompa Hortumu



Vestel Kazan Pompa Hortumu

PANO VE IŞIK TAŞIYICILAR



2892009355

Arçelik 7104 HSE Ön Pano



2892009232

Arçelik 8103 HE Ön Pano



2892009046

Arçelik 7083 H Ön Pano



2892009118

Arçelik 7104 HST Ön Pano



2892009229

Arçelik 7103 HE Ön Pano



2892009113

Arçelik 8103 HT Ön Pano



2892009116

Arçelik 8104 HT Ön Pano



2892009120

Arçelik 7103 HT Ön Pano

PANO VE IŞIK TAŞIYICILAR



2892009231

Arçelik 7104 HE Ön Pano



2892009233

Arçelik 8104 HE Ön Pano



2891400300

Arçelik 6083 Işık Taşıyıcı



2813590100

Arçelik Işık Taşıyıcı



2815730300

Arçelik Işık Taşıyıcı



2867700100

Arçelik Işık Taşıyıcı



2867700400

Arçelik Işık Taşıyıcı

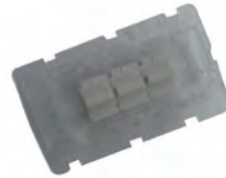

2870300500

Arçelik Işık Taşıyıcı



Bosch Tuş Yuvası

TERMOSTATLAR



2801730200

Arçelik Termostat



2700450100

Arçelik Termostat

TERMOSTATLAR



2600850000

Arçelik Termostat



2100790000

Arçelik Termostat



2704860200

Arçelik Termostat



Bosch Termostat



Vestel Termostat

KİREÇ ÖNLEYİCİ AKSESUARLAR



Wpro Manyetik Kireç Önleyici (Antikalker)



9197071841

Çamaşır Beyazlatıcı Tablet
32 ad



2973320100

Kurutma Makinesi Koku Kapsülü 25 g



Allgoo Manyetik Kireç Önleyici Antikalker



Allgoo Kireç Temizleyici Toz
5 li Paket

MUHTELİF PARÇALAR



Arçelik Tekmelik Pompa
Kapağı (2846350400)



Arçelik Tekmelik Pompa
Kapağı (2810920100)



2912701400

Vakumlu Ayak



Oçm Vidalı Ayak 4 lu Paket



Oçm Ayak Titreşim Takozu
4 lü



2801560100

Su Seviye



Tutmalı Tip Termostat
Düğmesi



2878409001

Arçelik Program Düğmesi



Bosch 1610 Program Düğme
Takımı



Bosch Tuş Düğmesi



Brennenstuhl Tekli Akım
Koruyucu Priz



Çalıştırma Kablosu 3x1,50
200 MM



09

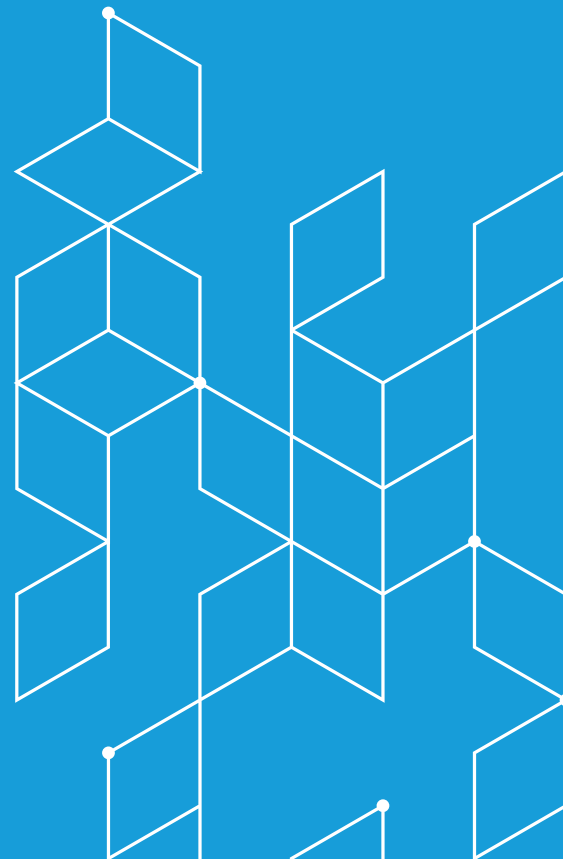

BULAŞIK MAKİNESİ

ELEKTRONİK KARTLAR	222
VENTİLLER	223
ANAHTARLAR	224
ISITICILAR	225
TAHLİYE POMPALARI	226
SİRKÜLASYON MOTORLARI	226
PARLATICI KUTULARI	227
PERVANELER	228
SEPETLER	228
TUZ KUTULARI	229
SU SAYAÇLARI	229
SU SEVİYE	230
TAHLİYE HORTUMLARI	230
MENTEŞELER	230
MUHTELİF ÜRÜNLER	231

BULAŞIK



ELEKTRONİK KARTLAR

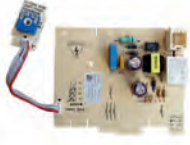

1784003530

Arçelik Elektronik Kart



1899611070

Arçelik Elektronik Kart



1899450140

Arçelik Elektronik Kart



1784003520

Arçelik Elektronik Kart



1784000510

Arçelik Elektronik Kart



1784003650

Arçelik Elektronik Kart



1899610121

Arçelik Elektronik Kart



1899450120

Arçelik Elektronik Kart



1899610171

Arçelik Elektronik Kart



1741310170

Arçelik Elektronik Kart



1899450260

Arçelik Elektronik Kart



1784003930

Arçelik Elektronik Kart



1899610980

Arçelik Elektronik Kart



1784000940

Arçelik Elektronik Kart

ELEKTRONİK KARTLAR



1784002740

Arçelik Elektronik Kart



1784002990

Arçelik Elektronik Kart



1899610890

Arçelik Elektronik Kart



1784000070

Arçelik Elektronik Kart



1899610131

Arçelik Elektronik Kart



1899610421

Arçelik Elektronik Kart



1899450160

Arçelik Elektronik Kart



1899610411

Arçelik Elektronik Kart

VENTİLLER



1760360200

Aqua Stop Hortumlu Ventil



Tekli 90 Derece Geçmeli Ventil



Tekli 90 Derece Vidalı Ventil



Arçelik Tekli Ventil Eski Tip Model 1

VENTİLLER



Arçelik Tekli Ventil Eski Tip
Model 2



Aqua Stop Hortumsuz Ventil
Model 1



Aqua Stop Hortumsuz Ventil
Model 2



Aqua Stop Hortumlu Ventil

ANAHTARLAR



Arçelik Kurutma Makinesi
Kapı Kilidi



Arçelik On Off Anahtar
1732090100



Vestel Ariston Bulaşık Kapı
Kilidi Model 1 (0219242)



Vestel Ariston Bulaşık Kapı
Kilidi Model 2 (0219243)



Kapı Emniyet Anahtarı Eski
Tip Kırmızı



Arçelik Bulaşık On Off
Anahtar



1833120400
Arçelik Bulaşık On Off
Anahtar



Hotpoint Ariston On Off
Anahtar

ANAHTARLAR



1731980300

Arçelik Kapı Emniyet Anahtarı



1510600300

Arçelik Kapı Kilidi



Arçelik Eski Tip Kapı Kilidi



041194 Ariston Kapı Emniyet Anahtarı

ISITICILAR



Arçelik Boru Tipi İnce Isıtıcı



Arçelik Boru Tipi Kalın Isıtıcı



Arçelik Eski Tip Isıtıcı



Ariston L Tipi Isıtıcı



Endüstriyel Bulaşık Makinesi Isıtıcı 2000-2500W



Endüstriyel Bulaşık Makinesi Isıtıcı 220V



Endüstriyel Bulaşık Makinesi Isıtıcı 220V-380V

TAHLİYE POMPALARI



Ariston Indesit Bulaşık
Plaset Pompa (272301)



Vestel Fagor Franke Bulaşık
Plaset Pompa



Arçelik Bulaşık Geçmeli Tip
Plaset Pompa



Vestel Bulaşık Geçmeli Tip
Plaset Pompa



Bosch Bulaşık Yeni Tip
Plaset Pompa



Bosch Bulaşık Eski Tip Sgs
Plaset Pompa



1748200100
Arçelik Orjinal Bulaşık
Pompa



Bosch Sgs İtalyan Plaset
Pompa



611332 Bosch Pompa



620774 Bosch Pompa

SİRKÜLASYON MOTORLARI



1740703000
Arçelik Orjinal Sirkülasyon
Motoru



1783900400
Arçelik Sirkülasyon Motoru
(Isıtıcısız)

SİRKÜLASYON MOTORLARI

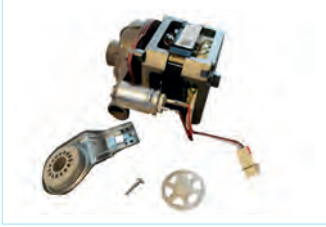

1740703100

Arçelik Orjinal Sirkülasyon Motoru



651956

Bosch Orjinal Sirkülasyon Motoru



1740701700

Arçelik Orjinal Sirkülasyon Motoru



1740703500

Arçelik Orjinal Sirkülasyon Motoru



1891000400

Arçelik Sirkülasyon Pompası



1740701800

Arçelik Sirkülasyon Pompası

PARLATICI KUTULARI



1718600200

Arçelik Parlaticı Kutusu Gri



1512300100

Arçelik Parlaticı Kutusu



1718601700

Arçelik Parlaticı Kutusu Şamandıralı



1718600900

Arçelik Parlaticı Kutusu Gri

PERVANELER



1759600100

Arçelik Üst Pervane Borusu



1738001700

Arçelik Pervana Besleme Borusu



Hotpoint Ariston Bulaşık Makinesi Üst Pervane So-munu C00144315



1512600100

Arçelik Atlantis Alt Pervane



1512700100

Arçelik Atlantis Üst Pervane



1746100300

Arçelik Alt Pervane



1746200600

Arçelik Üst Pervane

SEPETLER



Arçelik Alt Sepet

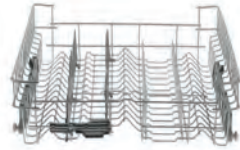

Arçelik Üst Sepet

TUZ KUTULARI



1744000100

Arçelik Tuz Kutusu



1744000200

Arçelik Tuz Kutusu



1837830100

Arçelik Tuz Kutusu



1883800400

Arçelik Tuz Kutusu

SU SAYAÇLARI



1760940100

Arçelik Su Sayac Türbün Kartı



Bosch Eski Tip Su Sayac Türbün Kartı



1760310100

Arçelik Su Sayac Türbün Kartı



1760900100

Arçelik Su Sayac Türbün



Bosch Yeni Tip Su Sayac Türbün Kartı



424099

Bosch Su Sayac Türbün

SU SEVİYE



1888100100

Arçelik Taşma Sivici Grubu

Su Taşma Grubu Sivici
1883240100

2801560100

Arçelik Su Seviye Anahtarı

TAHLİYE HORTUMLARI



1740160300

Arçelik Tahliye Hortumu



1853200200

Arçelik Tahliye Hortumu



1853200300

Arçelik Tahliye Hortumu



1800800100

Arçelik Tahliye Hortumu

MENTEŞELER

Bosch Bulaşık Makinesi
Kapak Menteşe Yay İp Seti
00754866Bosch Bulaşık Makinesi
Kapak Menteşe Yay İp Seti
00754867

MENTEŞELER



Bosch Bulaşık Makinesi
Kapak Mentеше Yay İp Seti
00754869



1881050100

Arçelik Mentеше İpi 2 li



Vestel Mentеше İpi 2 li



Arçelik Mentеше İpi 2 li

MUHTELİF ÜRÜNLER

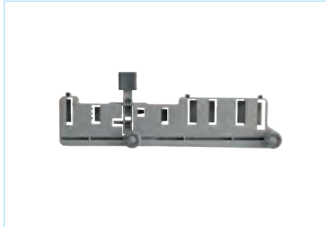

1781970700

Sepet Ayar Mekanizması Sol

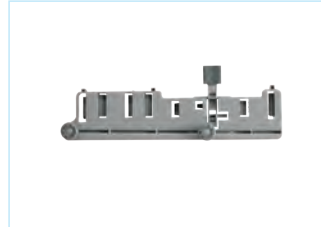

1781971000

Sepet Ayar Mekanizması
Sağ



Çatal Kaşık Sepeti



1800863200

Emiş Hortumu



1749190100

Arçelik Bulaşık Ön Kapak
Contası



Vestel Bulaşık Isıtıcı Siviç
Seti



9191470014 Bulaşık Makinesi
Temizleyici 200 ml



1760400100

Arçelik Üç Yollu Vana

MUHTELİF ÜRÜNLER



1882640701

Arçelik Üç Yollu Vana



1719990100

Arçelik Pompa Giriş Hortumu



1760200500

Arçelik Yan Su Cebi



AKE R006-01-01 5 Zamanlı Zaman Rölesi



Arçelik Yeni Tip Sepet Ray Tutucu Kapak



Arçelik Sepet Ray Arka Tutucu Kapak



Arçelik Sepet Ray Ön Tutucu Kapak



Arçelik Eski Tip Tutamak



5 Mf Kondansatör



1740110100

Arçelik Isıtıcı Hortumu



1740130100

Arçelik Isıtıcı Hortumu



Arçelik Alt Sızdırmazlık Contası



Bosch Alt Sızdırmazlık Contası



1766560100

Arçelik Tuz Kutusu Kapağı

MUHTELİF ÜRÜNLER



Sepet Teker (424717) Model 1 (Küçük)



Sepet Teker (1743830100) Model 2 (Büyük)



Sepet Teker (1885800500) Model 3



Sepet Teker (1885900400) Model 4

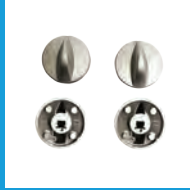
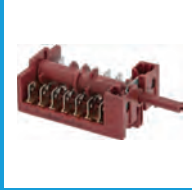

10



FIRIN

ISITICILAR	236
GAZ DÖNÜŞÜM EKİPMANLARI	237
FAN MOTORLARI	238
FLEX ÖRGÜLÜ HORTUMLAR	239
KOMUTATÖRLER	239
ATEŞLEME VE ÇAKMAK BUJİLERİ	240
DÜĞMELER	241
KAPI KOLLARI	242
MENTEŞELER	242
TERMOSTATLAR	243
TEMİZLİK AKSESUARLARI	243
MUHTELİF ÜRÜNLER	243

FIRIN

ISITICILAR



Arçelik Fırın Üst Isıtıcı
262100010



Bosch Fırın Üst Isıtıcı
360720



Arçelik Fırın Üst Isıtıcı
262900064



Arçelik Fırın Üst Isıtıcı



Fırın Üst Isıtıcı Üniversal
Model 1

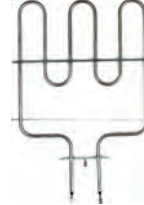

Fırın Alt Isıtıcı Üniversal
Model 2

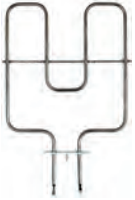

Fırın Alt Isıtıcı Üniversal
Model 3

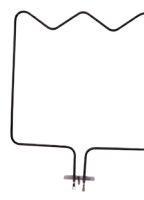

Arçelik Fırın Alt Isıtıcı



Arçelik Fırın Turbo Isıtıcı



Bosch Fırın Turbo Isıtıcı



Auer Fırın Turbo Isıtıcı



Davul Fırın Isıtıcı Elma Tip



Davul Fırın Isıtıcı Armut Tip

GAZ DÖNÜŞÜM EKİPMANLARI



Piyasa (4-5 Lokma) Lpg Enjektör Takımı



Bosch Arçelik Vestel (7 Lokma) Lpg Enjektör Takımı



Arçelik (9 Lokma) Lpg Enjektör Takımı



Piyasa (4-5 Lokma) Doğal Gaz Enjektör Takımı



Bosch Arçelik Vestel (7 Lokma) Doğal Gaz Enjektör Takımı



Arçelik (9 Lokma) Doğal Gaz Enjektör Takımı



Doğal Gaz Dönüşüm Contası 3/8



Doğal Gaz Dönüşüm Contası 1/2



Doğal Gaz Dönüşüm Contası 3/4



Teflon Bant



Teflon Bant Doğal Gaz



1/2 Doğal Gaz Dirsek



3/8 Doğal Gaz Dirsek



1/4 Doğal Gaz Dirsek

GAZ DÖNÜŞÜM EKİPMANLARI



1/2 Doğal Gaz Erkek Dirsek



1/2 Lpg Dirsek



3/8 Lpg Dirsek



1/2 Lpg Dik Dirsek



1/2 Kör Tapa



3/8 Kör Tapa

FAN MOTORLARI



Fırın Turbo Fan Motoru



Fırın Turbo Fan Kanadı



Piliç Çevirme Motoru













Döner - Piliç Çevirme Büyük Motor

FLEX ÖRGÜLÜ HORTUMLAR

	BAĞLANTI	HORTUMLAR
	1/2-1/2	50 CM
	1/2-1/2	75 CM
	1/2-1/2	100 CM
	1/2-1/2	125 CM
	1/2-1/2	150 CM
	1/2-1/2	200 CM

KOMUTATÖRLER

	163925006 Arçelik Fırın Komutator		300180042 Arçelik Fırın Komutator
	263900053 Arçelik Fırın Komutator		263900054 Arçelik Fırın Komutator
	263900055 - 263900019 Arçelik Fırın Komutator		263100032 Arçelik Fırın Komutator
	263100004 Arçelik Fırın Komutator		263100005 Arçelik Fırın Komutator
	163100005 Arçelik Fırın Komutator		İkili Işıklı Anahtar

KOMUTATÖRLER



Mini Fırın Anahtarı



3 Konumlu Bakalit Komutator



3 Konumlu Porselen Komutator

ATEŞLEME ÇAKMAK ve BUJİLERİ



Fırın Otomatik Çakmak



Uzun Butonlu Çakmak



Kısa Butonlu Çakmak



Setüstü Butonlu Çakmak



Kablolu Buji Model 1



Kablolu Buji Model 2



Kablolu Buji Model 3

DÜĞMELER



Arçelik Balta Düğme Takımı
Geniş

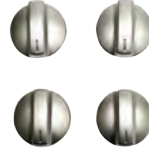

Set Üstü Düğme Takımı Dar
Gold Model 1



Set Üstü Düğme Takımı Dar
Gold Model 2

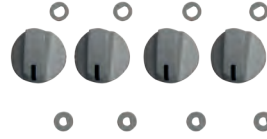

Üniversal Düğme Takımı
Beyaz Model 1



Üniversal Düğme Takımı
Beyaz Model 2



Üniversal Düğme Takımı
Beyaz Model 3



Üniversal Düğme Takımı
Beyaz Model 4



Üniversal Düğme Takımı
Beyaz Model 5



Üniversal Düğme Takımı
Gold Model 2



Üniversal Düğme Takımı
Gold Model 5



Üniversal Düğme Takımı
Siyah Model 1



Üniversal Düğme Takımı
Siyah Model 2



Üniversal Düğme Takımı
Siyah Model 4



Üniversal Düğme Takımı
Siyah Model 5

DÜĞMELER

Üniversal Tek Düğme Takımı
BeyazÜniversal Tek Düğme Takımı
SiyahÜniversal Yaylı Düğme
Takımı Beyaz

KAPI KOLLARI



Kodu

Arçelik Fırın Pimli Kapı Kolu

MENTEŞELER



223110098

Arçelik Fırın Üst Cam Kapan
Menteşe

210100076

Arçelik Fırın Kapak Mentеше

Arçelik Üst Cam Mentеше
Yayı

TERMOSTATLAR



50-300 Derece Ego Termostat



50-300 Derece Termostat

TEMİZLİK AKSESUARLARI



9197061828

İnok Yüzey Parlatıcı 500 ml



9197061827

İnok Ocak Temizleyici 500 ml



9197061831

İnok Ocak Temizleyici Krem 235 ml



9197061832

Vitroseramik ve Cam Yüzeyli Ocak



9197061830

Fırın İçi ve Izgara Temizleyici 500 ml

MUHTELİF ÜRÜNLER



Ankastre Baca Borusu 2 mt



Ankastre Baca Borusu 3 mt

MUHTELİF ÜRÜNLER

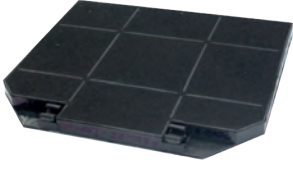

Ankastre Baca Borusu 10 mt

Davlumbaz Karbon Filtre
Bosch SilverlineDavlumbaz Karbon Filtre
Franke DominoxDavlumbaz Karbon Filtre
23x1609178002218 Arçelik
Mikrodalga YansıtıcıAspiratör Kağıt Filtre Kalın
Model 5 li

Aspiratör Tel Filtre Üiversal

Aspiratör 130x475 Kaset
FiltreAspiratör 165x515 Kaset
FiltreAspiratör 185x515 Kaset
FiltreAspiratör 205x475 Kaset
FiltreAspiratör 205x485 Kaset
FiltreAspiratör 250x300 Kaset
FiltreAspiratör 265x305 Kaset
Filtre

MUHTELİF ÜRÜNLER



Aspiratör 275x350 Kaset Filtre



Aspiratör 280x370 Kaset Filtre



Aspiratör 285x250 Kaset Filtre



Aspiratör 325x365 Kaset Filtre



Aspiratör 330x285 Kaset Filtre



Aspiratör 335x275 Kaset Filtre



Aspiratör 355x275 Kaset Filtre



Davlumbaz Şalteri 5 li



15W 300 C Ampul



Musluk İçi Yağ



255100045 Arçelik Fırın Kapak Contası



Plastik Ayak



Sabaf Ünivesal Bek Takımı



Zaman Saati



11



ISITMA



ŞOFBEN VE TERMOSİFON YEDEK PARÇALARI	248
ENDÜSTRİYEL MUTFAK YEDEK PARÇALARI	249
ÇAY VE SEMAVER YEDEK PARÇALARI	252
INFRARED ISITICI VE YEDEK PARÇALARI	253
ÜTÜ YEDEK PARÇALARI	254



ISITMA



ŞOFBEN VE TERMOSİFON YEDEK PARÇALARI



Arçelik Titanyum Termosifon Isıtıcı



Arçelik G 5 Termosifon Isıtıcı



4 Delikli Üiversal Termosifon Isıtıcı



6 Delikli Üiversal Termosifon Isıtıcı



Ariston Termosifon Isıtıcı



1-1/4 İnc Vidalı Termosifon Isıtıcı Bakır 2000W 220V



İhlas Şofben Isıtıcı



Kireç Magnet Anot Çubuğu



Güneş Gold Üç Kademeli Ani Su Isıtıcı Şofben



Termosifon Şofben Askı Aparatı



Termostat



Termosifon Emniyet Ventili Mandallı



Arçelik Diyafram Contası



Bosch Aeg Diyafram Contası

ŞOFBEN VE TERMOSİFON YEDEK PARÇALARI



İhlas Diyafram Contası



Muhtelif Modellere Diyafram Contası 1



Muhtelif Modellere Diyafram Contası 1



Şofben Sivici Model 1



Şofben Sivici Model 2



Şofben Sivici Model 3



Şofben Komutator

ENDÜSTRİYEL MUTFAK YEDEK PARÇALARI

Endüstriyel Bulaşık Isıtıcı
220VEndüstriyel Bulaşık Isıtıcı
220V-380VEndüstriyel Bulaşık Isıtıcı
3000W

Endüstriyel Isıtıcı 7500W

ENDÜSTRİYEL MUTFAK YEDEK PARÇALARI



Endüstriyel Bulaşık Makinesi
Isıtıcı 2000-2500W



Endüstriyel Bulaşık Isıtıcı



Endüstriyel Bulaşık Isıtıcı



Benmari Isıtıcı 30 cm



Benmari Isıtıcı 40 cm



Benmari Isıtıcı 50 cm



Benmari Isıtıcı 60 cm



Benmari Isıtıcı 70 cm



Benmari Isıtıcı 80 cm



Benmari Isıtıcı 90 cm



Dikdörtgen Flanşlı Kazan
Isıtıcı



Dikdörtgen Flanşlı Kazan
Isıtıcı



Dikdörtgen Flanşlı Kazan
Isıtıcı



Dikdörtgen Flanşlı Kazan
Isıtıcı

ENDÜSTRİYEL MUTFAK YEDEK PARÇALARI

Endüstriyel Chafing Dish
Reşo Isıtıcı

Endüstriyel Çorbalık Isıtıcı



Fritöz Isıtıcı 1



Fritöz Isıtıcı 2



Fritöz Isıtıcı 3



Fritöz Isıtıcı 4



Fritöz Isıtıcı 5



Yuvarlak Flanşlı Kazan Isıtıcı



Yuvarlak Flanşlı Kazan Isıtıcı



Zilli Zaman Saati



Ocak Musluğu Lpg 1/4

Ocak Musluğu Doğal Gaz
3/8

0-40 Derece Termostat



50-400 Derece Termostat

ÇAY VE SEMAVER YEDEK PARÇALARI



Semaver Isıtıcı 1000W



Semaver Isıtıcı 1500W



Semaver Isıtıcı 2000W



Semaver Isıtıcı 2500W

Çay Kazanı Boğazlı Isıtıcı
2000W

Ketil Isıtıcı Model 1



Ketil Isıtıcı Model 2



Ketil Isıtıcı Model 3



30-90 Derece Termostat

Semaver Döküm Isıtıcı
Model 1Semaver Döküm Isıtıcı
Model 2Semaver Kelebek Isıtıcı 1000
WSemaver Kelebek Isıtıcı 1500
WSemaver Kelebek Isıtıcı
2000 W

ÇAY VE SEMAVER YEDEK PARÇALARI



Çay Kazanı Boğazlı Isıtıcı
2000W



İran Semaver Isıtıcı



Semaver Çay Kazanı 30-120
Derece Termostat



Ateşleme Butonu



Semaver Musluk Başı İnce



Semaver Musluk Başı Kalın



Semaver Musluk Göstergeli



Semaver Musluk Göstergesiz



Semaver Musluk Dıştan
Vidalı

INFRARED ISITICI VE YEDEK PARÇALARI



1000 W Infrared Ufo Isıtıcı



1500 W Infrared Ufo Cam
Isıtıcı

INFRARED ISITICI VE YEDEK PARÇALARI



2000 W Infrared Ufo Cam Isıtıcı



2500 W Infrared Ufo Cam Isıtıcı



3000 W Infrared Ufo Cam Isıtıcı



Infrared Ufo Isıtıcı Camı



Infrared Ufo Isıtıcı Porselen

ÜTÜ YEDEK PARÇALARI



Ütü Termostat Model 1



Ütü Termostat Model 2



Ütü Termostat Model 3



Ütü Termostat Model 4



Ütü Termostat Model 5



Ütü Termostat Model 6

ÜTÜ YEDEK PARÇALARI



Ütü Termostat Model 7



Ütü Termostat Model 8



Ütü Termostat Model 9



Ütü Termostat Model 10



Ütü Termostat Model 11



Ütü Termostat Model 12



Fişli Ütü Kablosu

Buharlı - Kazanlı Ütü Sole-
noid Valf İtalyan



12



SÜPÜRGE



SÜPÜRGE MOTORLARI	258
SÜPÜRGE HORTUMLARI	262
ARA BORULARI	264
EMİCİ FIRÇALAR	264
ANAHTARLAR	266
ELYAF TOZ TORBALARI	266
KAĞIT TOZ TORBALARI	268
BEZ TORBALAR	270
FİLTRELER	270
TORBA KIZAKLARI	273
TUTAMAKLAR	273
HORTUM BAŞLIKLARI	274
KABLOLAR	274
POMPALAR	275
HAZNE GRUPLARI	275
MANDALLAR	276
ŞARJLI SÜPÜRGE PİLLERİ	278
MUHTELİF PARÇALAR	278



SÜPÜRGE



SÜPÜRGE MOTORLARI

AMETEK



Ametek RB17 220V Çift Fanlı Motor



Ametek RB60 220V Çift Fanlı Motor



Ametek 220V Üç Fanlı Motor



Ametek RB60 24V Üç Fanlı Motor



Ametek 220V Tek Fanlı Egzostlu Motor



Ametek 220V Çift Fanlı Egzostlu Motor



Ametek 220V Üç Fanlı Egzostlu Motor



Ametek 24V Çift Fanlı Egzostlu Motor



Ametek 220V Tek Fanlı İhlas Seperatörlü Motor



Ametek 220V Çift Fanlı İhlas Seperatörlü Motor



Ametek 220V Tek Fanlı Arnika Lura Seperatörlü Motor



Ametek 220V Mini Bakalit Motor



Ametek 220V Mini Bakalit Çıkıntılı Motor



Ametek 220V Nilfisk Motor

SÜPÜRGE MOTORLARI

AMETEK



Ametek 220V Fakir Bakalit Motor

SÜPÜRGE MOTORLARI

BEKATECH

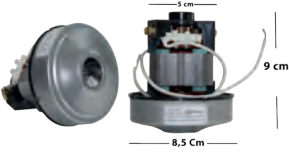

Süpürge Motoru Model 01
Fantom Pratik 500 Watt

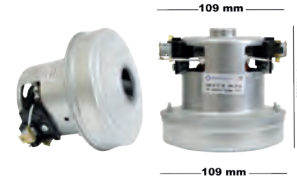

Süpürge Motoru Model 05
220V 1300 Watt



Süpürge Motoru Model 17
220V 1900 Watt



Süpürge Motoru Model 18
Arçelik 1900 Watt



Süpürge Motoru Model 19
Samsung 1400 Watt



Süpürge Motoru Model AL
25 Çıkıntılı 220V 1400 Watt



Süpürge Motoru Model 90
Bosch Mini Çıkıntılı 1800
Watt

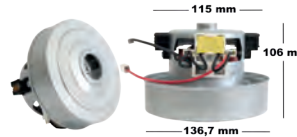

Süpürge Motoru Model 27
Dyson 1400 Watt



Süpürge Motoru Model 28
Philips Arzum 1800 Watt

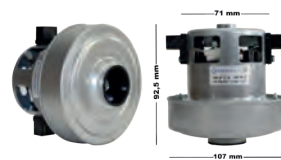

Süpürge Motoru Model 29
Philips 800 Watt

SÜPÜRGE MOTORLARI

BEKATECH



Süpürge Motoru Model 30
Arçelik Çıktıntısız 1200 Watt



Süpürge Motoru Model 31
Termikli 1600 Watt



Süpürge Motoru Model 32
Fakir, Arçelik, Vestel



Süpürge Motoru Model 33
Arçelik, Fakir



Süpürge Motoru Model 34
Arçelik Çıktıntılı 1600 Watt



Süpürge Motoru Model 35
Arçelik Çıktıntılı 1200 Watt



Süpürge Motoru Model 36
Samsung 1600 Watt



Süpürge Motoru Model 37
Samsung 1800 Watt



Süpürge Motoru Model 38
Arçelik Filtreli 1800 Watt



Süpürge Motoru Model 40
Arçelik Büyük Model



Süpürge Motoru Model 43
Arçelik 9320 Model



Süpürge Motoru Model 44
Arnica Bora 5000



Süpürge Motoru Model 45
Arzum, Conti, Arnica



Süpürge Motoru Model 48
Arnica Tırnaklı 1500 Watt

SÜPÜRGE MOTORLARI

BEKATECH



Süpürge Motoru Model 50-1
Rowenta 1400 Watt



Süpürge Motoru Model 55
Arnica, Fantom 1500 Watt



Süpürge Motoru Model 56
Vestel 1400 Watt



Süpürge Motoru Model 60
İki Fanlı Yıkamalı



Süpürge Motoru Model 60-24
İki Fanlı Bakır Sargılı 24V
400 Watt



Süpürge Motoru Model
70 İki Fanlı Egzostlu Bakır
Sargılı 220V 1400 Watt



Süpürge Motoru Model 70-24
İki Fanlı Egzostlu Bakır
Sargılı 24V 400 Watt



Süpürge Motoru Model
73 Üç Fanlı Egzostlu Bakır
Sargılı 220V 1200 Watt



Süpürge Motoru Model 73-24
Üç Fanlı Egzostlu Bakır
Sargılı 24V 400 Watt



Süpürge Motoru Model
80 İhlas Seperatörlü Bakır
Sargılı 220V 1200 Watt



Süpürge Motoru Model 81
Libelle Arnica Seperatörlü
Bakır Sargılı 220V 1200 Watt



Süpürge Motoru Model 91
Nilfisk Bakır Sargılı 1200
Watt



Süpürge Motoru Model 92
Philips 1400 Watt

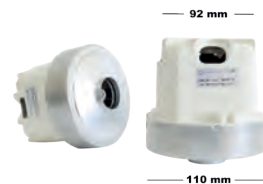

Süpürge Motoru Model 93
Philips 1200 Watt

SÜPÜRGE MOTORLARI

BEKATECH



Süpürge Motoru Model 94
1200 Watt



Süpürge Motoru Model
Domel 440 Philips 2100
Watt

SÜPÜRGE HORTUMLARI



Üniversal Çelik Telli Lüks
Hortum Başlıksız



Endüstriyel Süpürge Hortu-
mu 1. Kalite 5 Mt



Bosch Ergomaxx İthal 1.
Kalite Hortum



9178003184

Arçelik S 4250 Süpürge
Hortumu



Bosch 211 Lüks Hortum



Arnika Kazanlı 1. Kalite
Hortum



Fakir Veyron 1. Kalite Hortum



Fakir C 200 1. Kalite Hortum



Arnika Bora 3000 1. Kalite
Hortum



Arçelik 4240 1. Kalite
Hortum

SÜPÜRGE HORTUMLARI



Rowenta Rb 50 Kazanlı 1.
Kalite Siyah Hortum



Rowenta Rb 50 Kazanlı 1.
Kalite Gri Hortum



Fantom LUX Hortum



Fantom Yatık 1. Kalite Hor-
tum



Arçelik 945 1. Kalite Hortum



Arçelik 680 B 1. Kalite
Hortum



Arçelik 660 1. Kalite Hortum



Arçelik Islak Kuru 1. Kalite
Hortum



Arçelik 635 1. Kalite Hortum



Arçelik 4120 Kanguru 1.
Kalite Hortum



Vestel Vinto 1. Kalite Hortum



Vestel Targa 1. Kalite Hortum



Sinbo 1. Kalite Hortum

ARA BORULAR



9197059617

Arçelik Teleskobik Boru



Philips Çelik Teleskobik Boru



32 mm Rowenta Teleskobik Boru



35 mm Bosch Teleskobik Boru



32 mm Rowenta Plastik Boru



33 mm Fantom Plastik Boru



35 mm Bosch Plastik Boru



Pratik Kırmızı Plastik Boru



Pratik Beyaz Plastik Boru

EMİCİ FIRÇALAR



Philips Ultimate Emici



Rowenta Lüks Kutulu 32 mm Emici Fırça

EMİCİ FIRÇALAR



Fantom Lüks Kutulu 34 mm
Emici Firça



Bosch Lüks Kutulu 35 mm
Emici Firça



Rowenta Metal Tabanlı 32
mm Kartal Emici Firça



Fantom Metal Tabanlı 34
mm Kartal Emici Firça



Bosch Metal Tabanlı 35 mm
Kartal Emici Firça



Üniversal Plastik Tabanlı
Kartal Emici Firça



Pratik Kırmızı Emici



Pratik Beyaz Emici



Pratik Kartal Kırmızı Emici



Pratik Kartal Beyaz Emici



Bosch Aeg Basit Yer Emici



Rowenta 32 mm Basit Yer
Emici



Sanayi Tipi Koltuk Emici



Rowenta Tipi 32 mm Koltuk
Emici

ANAHTARLAR



Kodu

Üniversal Anahtar Model



Kodu

Üniversal Anahtar Model 2



Üniversal Anahtar Model 3



Tekli Kırmızı Geniş Işıklı Anahtar



Bosch Arnika 4 Soket Mikro Anahtar



Bosch Arnika 2 Soket Mikro Anahtar



Arçelik Fakir Vestel 2 Soket Mikro Anahtar



Arçelik Mite Anahtar

ELYAF TOZ TORBALARI



9197060560

Arçelik Tornado Silence Orj. S4910 Kutulu Elyaf



9197060561

Arçelik Tornadoflex Orj. S4960 Kutulu Elyaf



9197060559

Arçelik Vortexturbo Orj. S4540T Kutulu Elyaf



Bosch P Tipi Kutulu Elyaf

ELYAF TOZ TORBALARI



Bosch G ALL Tipi Kutulu Elyaf



Bosch G Tipi Kutulu Elyaf



Bosch G Tipi Kutulu İthal Elyaf



Philips S Bag Kutulu Elyaf



Philips S Bag İthal A Kalite Elyaf



Arçelik S4910 Tornado Zio Elyaf



Arçelik TT 420 Elyaf



Arçelik TT 635 Elyaf



Arçelik TT 990 Robotto Elyaf



Arçelik TT 680 B - TT 4120 Elyaf



Emotion Üniversal Elyaf



Bosch G Tipi Elyaf



Bosch P Tipi Elyaf



Vestel Vinto Elyaf

ELYAF TOZ TORBALARI



Rowenta Wonderbag Elyaf

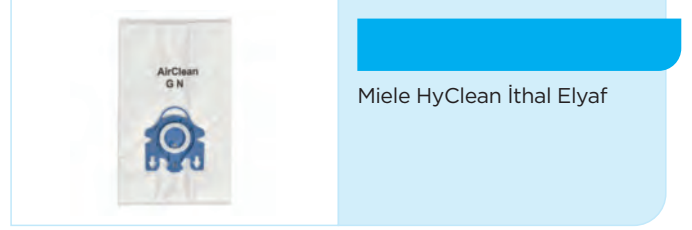

Miele HyClean İthal Elyaf



Fakir Prestige Elyaf

KAĞIT TOZ TORBALARI



Arçelik TT680B Kağıt Torba



Arçelik TT635 Kağıt Torba



Arçelik TT660 Dikey Kağıt Torba



Arçelik TT660 Yatay Kağıt Torba



Arçelik TT4120 Kanguru Kağıt



Arçelik TT945 Kağıt Torba



Arçelik TT970 Kağıt Torba



Arçelik TT550 Kağıt Torba

KAĞIT TOZ TORBALARI



Bosch 211 Kağıt Torba



Vestel Vinto Kağıt Torba



Arçelik Halı Yıkama Kağıt Torba



Fantom Arzum Kağıt Torba



Fantom Sinbo Kağıt Torba



Arnika Kağıt Torba



İhlas Halı Yıkama Kağıt Torba



Rowenta Rb50 Kağıt Torba



Fakir Halı Yıkama Kağıt Torba



Philips Athena Halı Yıkama Kağıt Torba



Rowenta Zr76 Kağıt Torba



Philips Sdney Kağıt Torba

BEZ TORBALAR



Arzum Hera Bez Torba



Fakir Darky Bez Torba



Rowenta Bez Torba



Arzum Arçelik Bez Torba



Fantom Yeni Tip Küçük Bez Torba



Fantom Küçük Bez Torba



Fantom Büyük Bez Torba



Pratik Bez Torba Model 1
Büyük



Pratik Bez Torba Model 2
Küçük

FİLTRELER



Üniversal Hepa Filtre 1 cm



Üniversal Hepa Filtre 1,5 cm

FİLTRELER



Üniversal Hepa Filtre 2 cm



Üniversal Motor Koruma Filtresi 12x17,5 cm



Philips Maraton Hepa Filtre Kutulu



Philips Ultimate Hepa Filtre



Philips FC 8716-8732 Silindirik Hepa Filtre



Philips FC 8070-CRP495 Hepa Filtre



Philips FC8044 Hepa Filtre



Philips 8475 Hepa Filtre Seti Kutulu



Philips 8475 Hepa Filtre



Philips Maraton Hepa Filtre Model 1



Philips Maraton Hepa Filtre Model 2



Arçelik Hepa Filtre Model 1



Arçelik Hepa Filtre Model 2



Arçelik Hepa Filtre Model 3

FİLTRELER



Arnika Bora Hepa Filtre



Arzum Arnika Hepa Filtre



Arnica Tesla Motor Koruma Filtresi



Bosch Kaset Filtre



Bosch Ergomax Hepa Filtre



Bosch Logo Hepa Filtre



Fakir Sünger Filtre



Fakir Ares Hepa Filtre



Fakir Clyde Hepa Filtre



Fakir Veyron Sünger ve Keçe Filtre



Fakir Veyron Hepa Filtre



Fakir Clyde Sünger ve Keçe Filtre



Fakir Duo Hepa Filtre



Rowenta Sünger Filtre

FİLTRELER



Rowenta Tefal Hepa Filtre
Bakım Seti



Rowenta Tefal Moulinex
Hepa Filtre Bakım Seti

TORBA KIZAKLARI



9193015014

Arçelik Toz Torba Tutucu



Fantom Torba Tutamak
Kızak



Bosch G Tipi Torba Tutamak
Kızak



Bosch Ergomax Torba Tutamak
Kızak



Bosch Logo Torba Tutamak
Kızak

TUTAMAKLAR



9197061872

Arçelik 4240 Üst Tutamak



9189045211

Arçelik Üst Tutamak

TUTAMAKLAR



9189045212 Arçelik Tutamak
Alt Parçası



Arnika Bora Üst Tutamak



Rowenta Twister Üst Tutamak



Rowenta Üst Tutamak

HORTUM BAŞLIKLARI



Hortum Başlığı İthal
Hareketli Model 32 mm



Hortum Başlığı İthal
Hareketli Model 35 mm



Rowenta Hortum Başlığı
Siyah 32 mm



Bosch Hortum Başlığı Siyah
35 mm

KABLolar



Fişli Süpürge Kablosu Standart
Tip 5 Mt



Fişli Süpürge Kablosu Yassı
Tip 5 Mt Siyah

POMPALAR



Ulka 28W Pompa



Ulka 48W Pompa



Ulka 54W Pompa



Ulka 16W 12V Pompa



Ulka 16W 24V Pompa

Jinyin 16 W Pompa Motoru
220 V

HAZNE GRUPLARI

Fantom Hamarat Kırmızı
HazneFantom Hamarat Beyaz
HazneFantom Hamarat Motor
Gövdesi KırmızıFantom Hamarat Motor
Gövdesi Beyaz

Fantom Pratik Kırmızı Hazne



Fantom Pratik Beyaz Hazne

HAZNE GRUPLARI



Fakir Darcy Hazne Kırmızı



Fakir Darcy Hazne Siyah



Arnica Merlin Hazne Bordo



Arnica Merlin Hazne Pembe



Arnica Merlin Hazne Şeffaf Mavi



Arnica Merlin Hazne Şeffaf Sarı



Arnica Merlin Hazne Şeffaf Yeşil



Arnica Merlin Hazne Turkuaz

MANDALLAR



Arnica Yan Mandal



Fantom Yeni Tip Yan Mandal



Fantom Yan Mandal



Arçelik Arzum Yan Mandal

MANDALLAR



Rowenta Yan Mandal

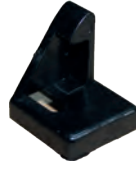

Fantom Pratik Gövde Mandal



Fantom Pratik Gövde Mandal 2



Fantom Hamarat Gövde Mandal



Sinbo-Premier Gövde Mandal



Blue House Gövde Mandal



Fakir Darky Gövde Mandal



Goldmaster Gövde Mandal



Homemax-Felix Gövde Mandal



Arzum-Hera Gövde Mandal



Arzum Pilot Tırnak Yan Mandal

ŞARJLI SÜPÜRGE PİLLERİ



6V Şarjlı Pil



İkili Dikey Şarjlı Pil



İkili Yatay Şarjlı Pil



Üçlü Dikey Şarjlı Pil



Üçlü Yatay Şarjlı Pil

MUHTELİF PARÇALAR



Arnica Emici Fırça Teker



Bluehouse Emici Fırça Adaptörü



Sinbo Emici Fırça Adaptörü



9197061829

TV ve Bilgisayar Ekran Temizleyici 200 ml



9197062326

Çok Amaçlı Mikrofiber Temizlik Bezi 2 ad



9197071843

Elektrikli Süpürge Kokusu 3 ad

